

# STATE OF TEXAS DEPARTMENT OF TRANSPORTATION PLANS OF PROPOSED HIGHWAY ROUTINE MAINTENANCE CONTRACT

GRAPHICS FILE		MAINTENANCE PROJECT NO.		SHEET NO.
Title2024.dgn		RMC-646517001		1
CHECKED	STATE	STATE DIST.	COUNTY	
MS	TEXAS	DALLAS	COLLIN	
CHECKED	CONT.	SECT.	JOB	HIGHWAY NO.
JRV	6465	17	001	US0075

## INDEX OF SHEETS

- | SHEET NO. | DESCRIPTION                        |
|-----------|------------------------------------|
| 1         | TITLE SHEET                        |
| 2         | ESTIMATE & QUANTITY SHEET          |
| 3A-3E     | GENERAL NOTES                      |
| 4-8       | TSR(1)-13 THRU TSR(5)-13           |
| 9-20      | BC(1)-21 THRU BC(12)-21            |
| 21        | TCP(6-8)-14                        |
| 22        | SMD(GEN)-08                        |
| 23-25     | SMD(SLIP-1)-08 THRU SMD(SLIP-3)-08 |

### TYPE OF WORK:

SMALL SIGN REPLACEMENT

PROJECT NO.: RMC-646517001

HIGHWAY : US0075

LIMITS : DALLAS COUNTY LINE TO  
GRAYSON COUNTY LINE

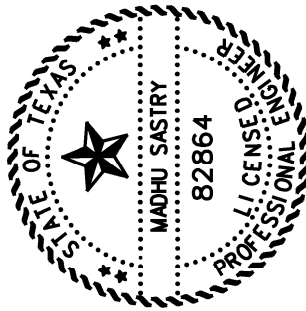
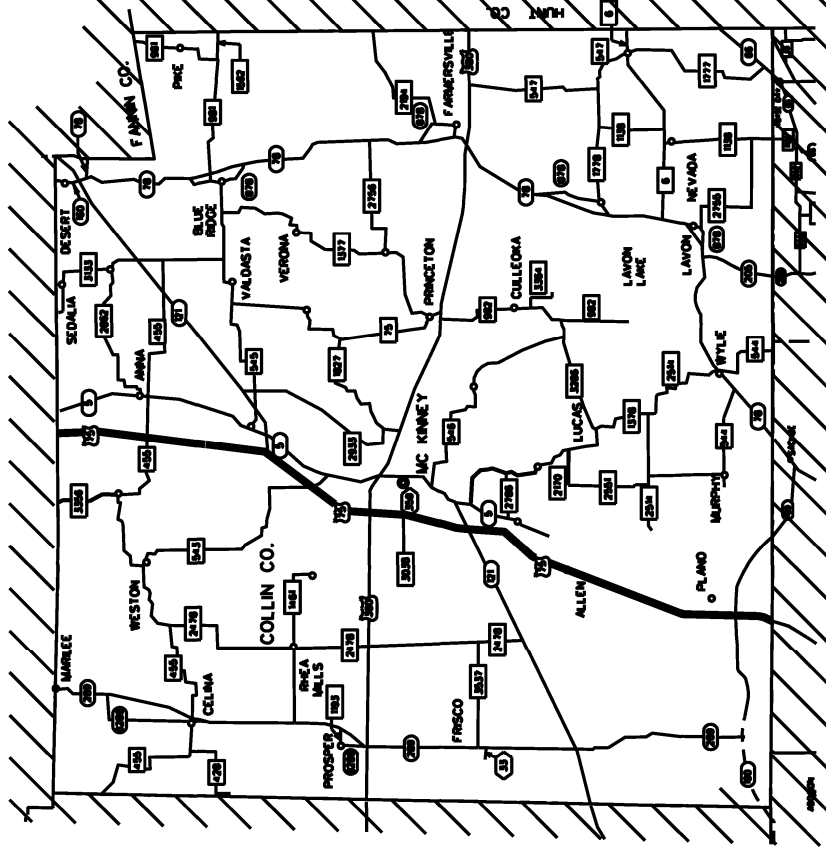

THE STANDARD SHEETS SPECIFICALLY IDENTIFIED ABOVE HAVE BEEN SELECTED BY ME OR UNDER MY RESPONSIBLE SUPERVISION AS BEING APPLICABLE TO THIS PROJECT.

DocuSigned by:  
*Madhu Sastry*  
5C42420C7BA4418 PE 9/17/2024

SPECIFICATIONS ADOPTED BY THE TEXAS DEPARTMENT OF TRANSPORTATION SEPTEMBER 1, 2024 AND SPECIAL SPECIFICATION ITEMS INCLUDED IN THE CONTRACT SHALL GOVERN ON THIS PROJECT.



Texas Department of Transportation

RECOMMENDED FOR LETTING

DocuSigned by:  
*Jennifer Vorster*  
4B966E9936D4F... AREA ENGINEER 9/17/2024

RECOMMENDED FOR LETTING

DocuSigned by:  
*David Momen, P.E.*  
72258D0350B94E4... DISTRICT MAINTENANCE ENGINEER 9/17/2024

RECOMMENDED FOR LETTING

DocuSigned by:  
*JEFFREY BUSH*  
345B765E03E40B... DIRECTOR OF OPERATIONS 9/17/2024

# Estimate & Quantity Sheet



CONTROLLING PROJECT ID 6465-17-001 DISTRICT Dallas  
HIGHWAY US0075

COUNTY Collin

CONTROL SECTION JOB		6465-17-001		TOTAL EST.	TOTAL FINAL
PROJECT ID		A00207997			
COUNTY		Collin			
HIGHWAY		US0075			
ALT	BID CODE	DESCRIPTION	UNIT	EST.	FINAL
	500-7002	MOBILIZATION (CALLOUT)	EA	27.000	27.000
	505-7001	TMA (STATIONARY)	DAY	27.000	27.000
	644-7073	REMOVE SM RD SN SUP&AM	EA	20.000	20.000
	644-7107	REPLACE SRSA TYS80(2)SA(P)EXCLUDE SIGN	EA	15.000	15.000
	644-7108	REPLACE SRSA TYS80(2)SB(P)EXCLUDE SIGN	EA	25.000	25.000

DISTRICT	COUNTY	CCSJ	SHEET
Dallas	Collin	6465-17-001	2

**Project Number:** RMC-646517001

**Control:** 6465-17-001

**County:** Collin

**Highway:** US0075

**General:**

This project consists of performing "Small Sign Replacement" on US 75 in the Collin County Maintenance Section.

Work to be performed under this contract is Non-Site Specific.

Sequence of work will be approved.

"Non-Site Specific" minimum per written notification will be 3 EA, Small Roadside Assemblies (SRSA).

Provide and maintain a dedicated email address for receipt of work orders and correspondence throughout the term of this contract. Acknowledgement of emailed work order/callouts is required no more than 12 hr. from notification.

Contractor's attention is called to the fact that all adjoining pavement sections will be protected during all phases of construction and any damages incurred due to Contractor's operation will be repaired and replaced at the Contractor's expense.

Coordinate work through:

Derick Davis  
2205 South SH 5  
McKinney, Texas 75069  
972-542-2461

Bids will be received at 4777 E. Hwy 80, Mesquite, Texas 75150-6643.

Contractor questions on this project are to be addressed to the following individuals:

Jennifer Vorster, P.E.                      Jennifer.Vorster@txdot.gov  
Derick Davis                                      Derick.Davis@txdot.gov

Questions may be submitted via the Letting Pre-Bid Q&A web page. This webpage can be accessed from the Notice to Contractors dashboard located at the following Address:

<https://tableau.txdot.gov/views/ProjectInformationDashboard/NoticetoContractors>

All contractor questions will be reviewed by the Engineer. All questions and any corresponding responses that are generated will be posted through the same Letting Pre-Bid Q&A web page.

The Letting Pre-Bid Q&A web page for each project can be accessed by using the dashboard to navigate to the project you are interested in by scrolling or filtering the dashboard using the

**Project Number:** RMC-646517001

**Control:** 6465-17-001

**County:** Collin

**Highway:** US0075

controls on the left. Hover over the blue hyperlink for the project you want to view the Q&A for and click on the link in the window that pops up.

Attention is directed to the possible presence of underground utilities owned by the Texas Department of Transportation (irrigation, signal, illumination and surveillance, communication, and control) on the right of way. Call the Department for locates at 214-320-6682 48 hr. in advance of excavation. Contact the appropriate department of the local city or town a minimum of 48 hr. in advance of excavation.

If overhead or underground power lines need to be de-energized, contact the electrical service provider to perform this work. Cost associated with de-energizing the power lines or other protective measures required are at no expense to the Department.

If working near power lines, comply with the appropriate sections of Texas State Law and Federal Regulations relating to the type of work involved.

**Item 2 – Instructions to Bidders:**

This project includes plan sheets that are not part of the bid proposal.

View or download plans at:

<http://www.dot.state.tx.us/business/plansonline/agreement.htm>

**Item 4 – Scope of Work:**

Contract extensions will be mutually agreed upon six months prior to the completion of the project.

Unit prices may be adjusted to reflect the current Federal Consumer Price Index for the Southern Region.

**Item 7 – Legal Relations and Responsibilities:**

Pre-construction safety meeting will be conducted with Contractor's personnel prior to work beginning on a continuously prosecuted contract or before each callout work request.

Attendance of this meeting will not be paid directly but considered subsidiary to the various bid items.

**Project Number:** RMC-646517001

**Control:** 6465-17-001

**County:** Collin

**Highway:** US0075

Holiday restrictions – the Engineer may decide that no lane closures or construction operations will be allowed during the restricted periods listed in the following holiday schedule. TxDOT has the right to lengthen, shorten, or otherwise modify these restricted periods as actual, or expected, traffic conditions may warrant. Working days will not be charged for these restricted periods. No additional compensation will be allowed for these restricted closures (i.e., overhead, delays, stand-by, barricades or any other associated cost impacts).

- New Year's Eve and Day (noon on December 31 thru 10 P.M. January 1)
- Easter Holiday weekend (noon on Friday thru 10 P.M. Sunday)
- Memorial Day weekend (noon on Friday thru 10 P.M. Monday)
- Independence Day (noon on July 3 thru 10 P.M. on July 5)
- Labor Day weekend (noon on Friday thru 10 P.M. Monday)
- Thanksgiving Holiday (noon on Wednesday thru 10 P.M. Sunday)
- Christmas Holiday (noon on December 23 thru 10 P.M. December 26)

Holiday restrictions for Independence Day, Thanksgiving Holiday, and the Christmas Holiday may be extended for the “week of” due to the nature of work being performed and the work location at the discretion of the Engineer for safety of the traveling public.

Roadway closures during the following key dates and/or special events are prohibited.

- The University of Texas vs. University of Oklahoma football game (no lane closures beginning 4 hr. prior to the event and ending 3 hr. following event completion).

**Item 8 – Prosecution and Progress:**

Working days will be charged in accordance with Section 8.3.3.2.1, “Nighttime Work Only”.

Contract days will be charged in accordance with Section 8.3.1.5, “Calendar Day”.

**Item 502 – Barricades, Signs, and Traffic Handling:**

Provide traffic control in compliance with the latest edition of the “Texas Manual on Uniform Traffic Control Devices” (TMUTCD), the “Traffic Control Standard Sheets” (TCSS), and as directed.

General Notes

Sheet 3C

**Project Number:** RMC-646517001

**Control:** 6465-17-001

**County:** Collin

**Highway:** US0075

All work requiring lane closures on US0075 will be performed Sunday through Thursday between 9 P.M. and 5:30 A.M., unless otherwise approved. Close no more than one lane at a time, unless otherwise approved. Provide proposed lane closure information to the Engineer by 1 P.M. on the day prior to the proposed closures. Furnish information for Sunday closures or closures following a national or state holiday on the last office workday prior to the closures. Do not close lanes if the above reporting requirements have not been met.

Daytime and weekend work may be allowed with prior approval.

Maximum length of lane closure will be 2 miles.

Traffic Control Plans with a lane closure causing backups of 10 minutes or greater in duration will be modified by the Engineer.

Trailer all slow-moving vehicles (designed to operate 25 mph or less) crossing freeway main lanes.

When moving unlicensed equipment on or across any pavement or public highways, protect the pavement from all damage using an acceptable method.

Equipment and materials will not be left within 30 ft. of the travel lane during non-working hours.

**Item 505 – Truck Mounted Attenuator (TMA):**

The total number of truck mounted attenuators (TMA) required when utilizing the traffic control standards are shown in the table below.

TCP 6 Series (6-8)-14	Scenario	Required TMA/TA
	All	1

Shadow vehicles equipped for truck mounted attenuators (TMA) for mobile and stationary operations must be available for use at any time as determined by the Engineer.

The Contractor will be responsible for determining if one or more of these operations will be ongoing at the same time to determine the total number of TMA needed for the project for those times per plan requirements. Additional TMAs used that are not specified in the plans in which the Contractor expects compensation will require prior approval from the Engineer.

When TMA's are paid by the hour or day, “ready for operation” is defined as all equipment, material, personnel, etc. are present on the project ready to begin work.

General Notes

Sheet 3D

**Project Number:** RMC-646517001

**Control:** 6465-17-001

**County:** Collin

**Highway:** US0075

**Items 644 – Small Sign Assemblies:**

TxDOT will provide all signs and hardware for sign assemblies at the Collin County Area Office.

A 3-inch strip of red reflective sheeting shall be placed on all Do Not Enter sign assemblies. This sheeting shall be placed directly below the Do Not Enter sign for the entire length of the signpost facing wrong way traffic. This work will be considered subsidiary to Item 644.

Torque the anchor bolts for only the Exit Gore signs to 60 foot-pounds.

# REQUIREMENTS FOR OVERHEAD AND LARGE GROUND-MOUNTED SIGNS

TYPICAL EXAMPLES

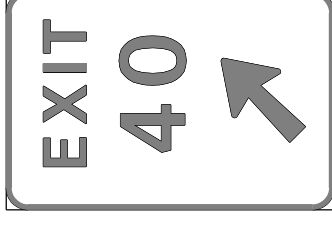
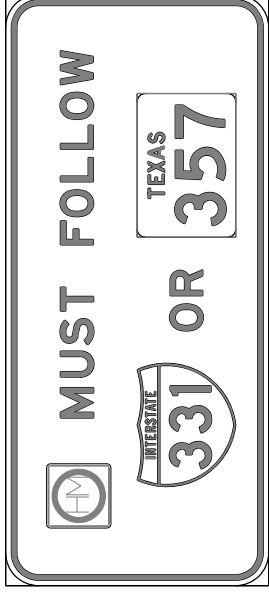
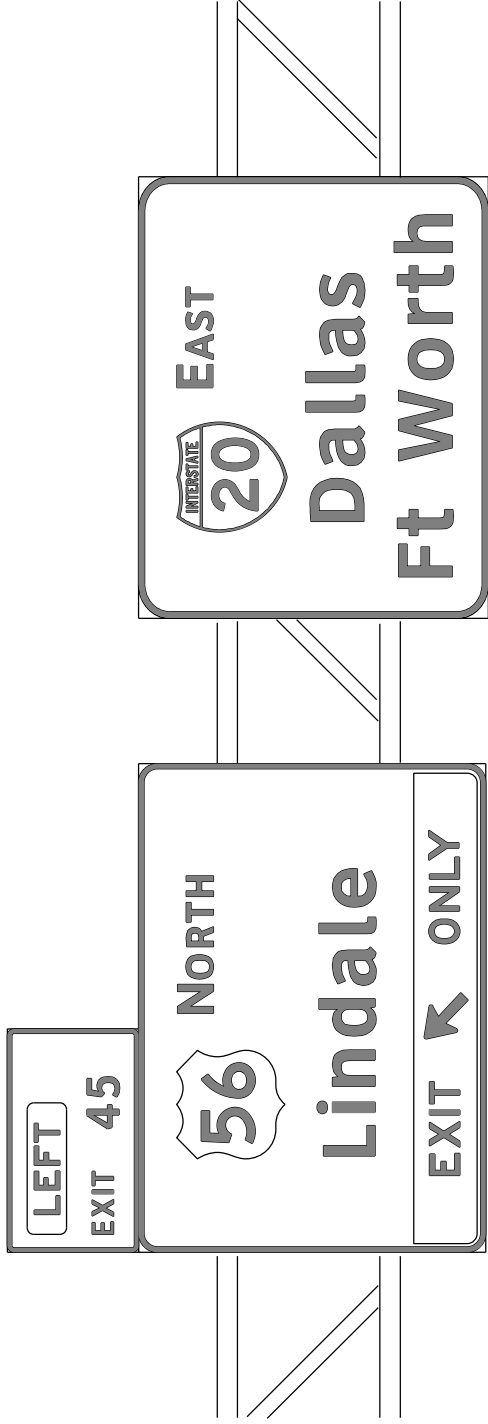

### GENERAL NOTES

- Signs to be furnished shall be as detailed elsewhere in the plans and/or as shown on sign summary sheet. Standard sign designs and arrow dimensions can be found in the "Standard Highway Sign Designs for Texas" (SHSD).
- Black legend shall use the Federal Highway Administration (FHWA) Standard Highway Alphabets (B, C, D, E, Emod, or F).  
White legend shall use the Clearview Alphabet.  
The following Clearview fonts shall be used to replace the existing white FHWA lettering, when not specified in the SHSD or in the plans.  

B	CV-1W
C	CV-2W
D	CV-3W
E	CV-4W
Emod	CV-5WR
F	CV-6W
- Lateral spacing between letters and numerals shall conform with the SHSD, and any approved changes thereto. Lateral spacing of legend shall provide a balanced appearance when spacing is not shown.
- Black legend shall be applied by screening process or cut-out acrylic non-reflective black film to background sheeting, or combination thereof.
- White legend and borders shall be cut-out white sheeting applied to colored background sheeting.
- Information regarding borders and radii for signs is found in the "Standard Highway Sign Designs for Texas". Dimensions shown and described for borders and corner radii on parent sign are nominal. Borders may vary in width as much as 1/2 inch. Corner radii above 3 inches may vary in width as much as 1 inch. Borders and corner radii within a parent sign must be of matching widths. The sign area outside the corner radius need not be trimmed or rounded if fabricated from an extruded material.
- Sign substrate for ground-mounted signs shall be any material that meets the Departmental Material Specification requirements of DMS-7110 or approved alternative. Sign substrate for overhead signs shall be any material that meets DMS-7110. Exit Number Panels attached above the parent sign shall be made with the same substrate and sheeting as the parent sign.
- Mounting details of attachments to parent sign face are shown on Standard Plan Sheet TSR(5). Mounting details of exit number panels above parent sign are shown in the "SMD series" Standard Plan Sheets.
- Background sheeting shall be applied to the substrate per sheeting manufacturer's recommendations. Sheeting will not be allowed to bridge the horizontal gap between panels.
- Cut all legend, symbols, borders, and direct applied sign attachments at panel joints.

DEPARTMENTAL MATERIAL SPECIFICATIONS	
ALUMINUM SIGN BLANKS	DMS-7110
SIGN FACE MATERIALS	DMS-8300

The Standard Highway Sign Designs for Texas (SHSD) can be found at the following website:  
<http://www.txdot.gov/>

SHEETING REQUIREMENTS	
USAGE	SIGN FACE MATERIAL
BACKGROUND	TYPE B OR C SHEETING
BACKGROUND	TYPE B OR C SHEETING
LEGEND & BORDERS	TYPE D SHEETING
LEGEND & BORDERS	ACRYLIC NON-REFLECTIVE FILM

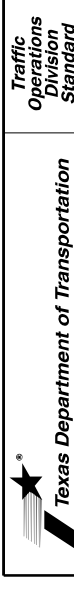

## TYPICAL SIGN REQUIREMENTS

TSR(1)-13

FILE:	tsr1-13.dgn	DN:	TxDOT	DW:	TxDOT	CK:	TxDOT
© TxDOT	October 2003	CONT:	SECT	JOB:		HIGHWAY:	
12-03	7-13	REVISIONS:	6465	17	001	US0075	
9-08		DIST:	DAL	COUNTY:	COLLIN	SHEET NO.:	4

REQUIREMENTS FOR ATTACHMENTS TO OVERHEAD AND LARGE GROUND MOUNTED SIGNS

DEPARTMENTAL MATERIAL SPECIFICATIONS	
ALUMINUM SIGN BLANKS	DMS-7110
SIGN FACE MATERIALS	DMS-8300

SHEETING REQUIREMENTS		
USAGE	COLOR	SIGN FACE MATERIAL
BACKGROUND	ALL	TYPE B OR C SHEETING
LEGEND & BORDERS	BLACK	ACRYLIC NON-REFLECTIVE FILM
LEGEND & BORDERS	ALL OTHERS	TYPE B OR C SHEETING

GENERAL NOTES

1. Signs to be furnished shall be as detailed elsewhere in the plans and/or as shown on sign tabulation sheet. Standard sign designs and arrow dimensions can be found in the "Standard Highway Sign Designs for Texas" (SHSD).
2. Route Marker legends (ie. IH, US, SH and FM shields) shall use the Federal Highway Administration (FHWA) Standard Highway Alphabets (B, C, D, E, Emod, or F).
3. Lateral spacing between letters and numerals shall conform with the SHSD, and any approved changes thereto. Lateral spacing of legend shall provide a balanced appearance when spacing is not shown.
4. Black legend and borders shall be applied by screening process or cut-out acrylic non-reflective black film to background sheeting, or combination thereof.
5. White legend and borders shall be applied by screening process with transparent colored ink, transparent colored overlay film to white background sheeting or cut-out white sheeting to colored background sheeting, or combination thereof.
6. Colored legend and borders shall be applied by screening process with transparent colored ink, transparent colored overlay film or colored sheeting to white background sheeting, or combination thereof.
7. Route markers and other attachments within the parent sign face shall be direct applied unless otherwise specified in the plans. Attachments not direct applied shall use 0.063 inch thick one piece sheet aluminum signs (Type A).
8. General Service Plaques shall be 0.080 inch thick and Routing Plaques shall be 0.100 inch thick.
9. The priority for Routing Plaques shall be (left to right) Hazardous Material, Airport then Hospital. See examples for mounting location.
10. Mounting details of attachments to parent signs face are shown on Standard Plan Sheet TSR(5). Mounting details of sign plaque attachments above and below parent sign are shown in the "SMD series" Standard Plan Sheets.
11. Plaques shall be horizontally centered at the top of the parent sign. If an exit number panel exists, the plaque shall be centered between the edge of the parent sign and the edge of the exit number panel. The plaque may be placed above the exit number panel when there is insufficient space.

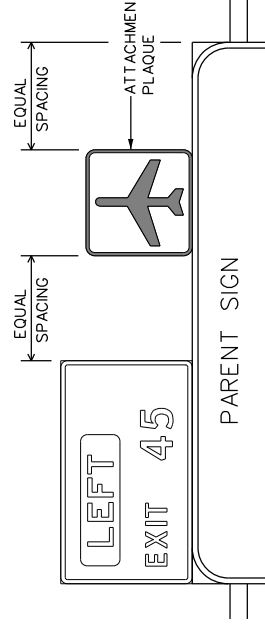
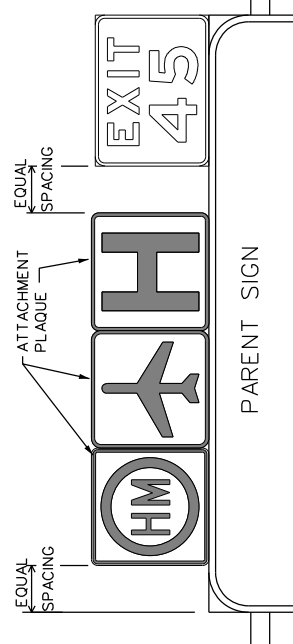
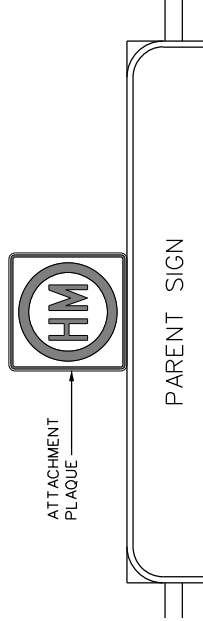
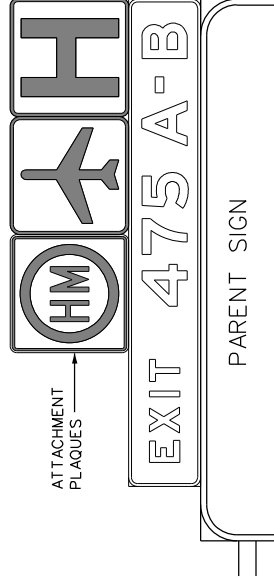
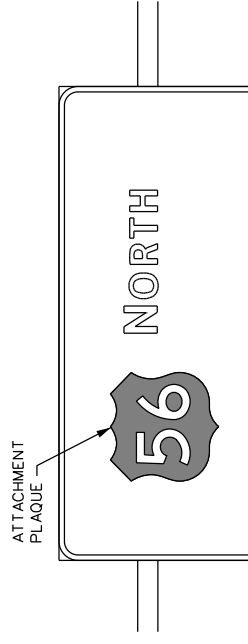

REQUIREMENTS FOR EXIT ONLY AND LEFT EXIT PANELS

DEPARTMENTAL MATERIAL SPECIFICATIONS	
ALUMINUM SIGN BLANKS	DMS-7110
SIGN FACE MATERIALS	DMS-8300

SHEETING REQUIREMENTS FOR OVERHEAD EXIT PANELS		
USAGE	COLOR	SIGN FACE MATERIAL
BACKGROUND	FLUORESCENT YELLOW	TYPE B <sub>FL</sub> OR C <sub>FL</sub> SHEETING
LEGEND	BLACK	ACRYLIC NON-REFLECTIVE FILM

GENERAL NOTES

1. Signs to be furnished shall be as detailed elsewhere in the plans and/or as shown on sign tabulation sheet. Standard sign designs and arrow dimensions can be found in the "Standard Highway Sign Designs for Texas" (SHSD). Individual panel sizes shown in the plans may be adjusted to fit actual parent sign sizes if necessary.
2. Exit Panel legend shall use the Federal Highway Administration (FHWA) Standard Highway Alphabets E Series.
3. Lateral spacing between letters and numerals shall conform with the SHSD, and any approved changes thereto. Lateral spacing of legend shall provide a balanced appearance when spacing is not shown.
4. Black legend shall be applied by screening process or cut-out acrylic non-reflective black film to yellow background sheeting, or combination thereof.
5. Exit Only and Left Exit panels within the parent sign face shall be direct applied unless otherwise specified in the plans. Panels not direct applied shall use 0.063 inch thick one piece sheet aluminum signs (Type A).
6. Mounting details of Exit Only and Left Exit panel attachments to parent signs face are shown on Standard Plan Sheet TSR(5).

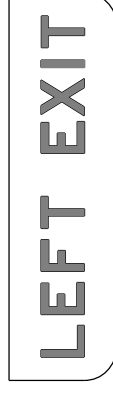
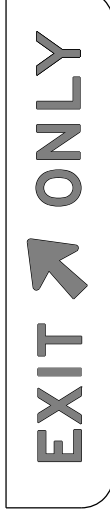
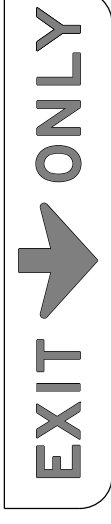

TYPICAL EXAMPLES

The Standard Highway Sign Designs for Texas (SHSD) can be found at the following website:  
<http://www.txdot.gov/>

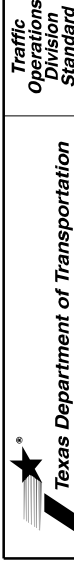
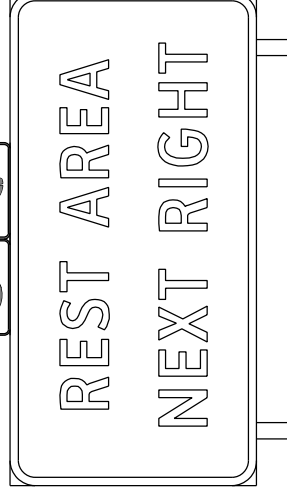
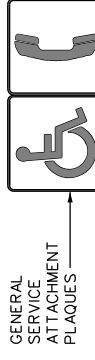

TYPICAL SIGN REQUIREMENTS

TSR(2) - 13

FILE:	tsr2-13.dgn	DATE:	TXDOT	CHK:	TXDOT	HWY:	CK:	TXDOT
CONT:	October 2003	REVISED:	6465	17	JOB:	001	US0075	
DIST:	12-03	COUNTY:	7-13	DAL	COUNTY:	COLLIN	SHEET NO.:	5

### REQUIREMENTS FOR INDEPENDENT MOUNTED ROUTE SIGNS

SHEETING REQUIREMENTS		
USAGE	COLOR	SIGN FACE MATERIAL
BACKGROUND	WHITE	TYPE A SHEETING
BACKGROUND	ALL OTHERS	TYPE B OR C SHEETING
LEGEND & BORDERS	WHITE	TYPE A SHEETING
LEGEND & BORDERS	BLACK	ACRYLIC NON-REFLECTIVE FILM
LEGEND & BORDERS	ALL OTHERS	TYPE B or C SHEETING

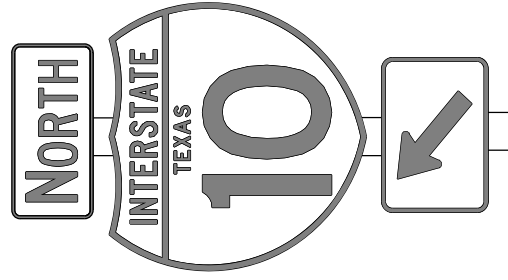

TYPICAL EXAMPLES

### REQUIREMENTS FOR BLUE, BROWN & GREEN D AND I SERIES GUIDE SIGNS

SHEETING REQUIREMENTS		
USAGE	COLOR	SIGN FACE MATERIAL
BACKGROUND	ALL	TYPE B OR C SHEETING
LEGEND & BORDERS	WHITE	TYPE D SHEETING
LEGEND, SYMBOLS & BORDERS	ALL OTHERS	TYPE B OR C SHEETING

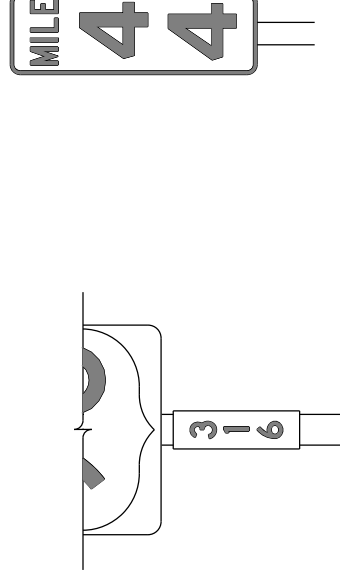

TYPICAL EXAMPLES

### GENERAL NOTES

- Signs to be furnished shall be as detailed elsewhere in the plans and/or as shown on sign tabulation sheet. Standard sign designs and arrow dimensions can be found in the "Standard Highway Sign Designs for Texas" (SHSD).
- White legend shall use the Clearview Alphabet. The following Clearview fonts shall be used to replace the existing white Federal Highway Administration (FHWA) Standard Highway Alphabets, when not specified in the SHSD, or in the plans.
 

B	CV-1W
C	CV-2W
D	CV-3W
E	CV-4W
Emod	CV-5WR
F	CV-6W
- Route sign legend (ie. IH, US, SH and FM shields) shall use the Federal Highway Administration (FHWA) Standard Highway Alphabets B, C, D, E, Emod or F).
- Lateral spacing between letters and numerals shall conform with the SHSD, and any approved changes thereto. Lateral spacing of legend shall provide a balanced appearance when spacing is not shown.
- Independent mounted route sign with white or colored legend and borders shall be applied by screening process with transparent color ink, transparent colored overlay film to white background sheeting or cut-out white sheeting to colored background sheeting, or combination thereof. White legend, symbols and borders on all other signs shall be cut-out white sheeting applied to colored background sheeting.
- Information regarding borders and radii for signs is found in the "Standard Highway Sign Designs for Texas". Dimensions shown and described for borders and corner radii on parent sign are nominal. Borders may vary in width as much as 1/2 inch. Corner radii above 3 inches may vary in width as much as 1 inch. Borders and corner radii within a parent sign must be of matching widths. The sign area outside the corner radius should be trimmed or rounded.
- Sign substrate shall be any material that meets the Departmental Material Specification requirements of DMS-7110 or approved alternative.
- Mounting details of roadside signs are shown in the "SMD series" Standard Plan Sheets.

DEPARTMENTAL MATERIAL SPECIFICATIONS	
ALUMINUM SIGN BLANKS	DMS-7110
SIGN FACE MATERIALS	DMS-8300

ALUMINUM SIGN BLANKS THICKNESS	
Square Feet	Minimum Thickness
Less than 7.5	0.080
7.5 to 15	0.100
Greater than 15	0.125

The Standard Highway Sign Designs for Texas (SHSD) can be found at the following website:  
<http://www.txdot.gov>

**Texas Department of Transportation**

**TYPICAL SIGN REQUIREMENTS**

**TSR(3)-13**

FILE:	tsr3-13.dgn	DN:	TxDOT	CK:	TxDOT	DW:	TxDOT	CK:	TxDOT
CONT:	October 2003	SECT:		JOB:		HIGHWAY:			
REVISIONS:	6465	17	001	US0075					
DATE:	12-03	7-13		COUNTY:					
DATE:	9-08			DAL:		COLLIN			6

DISCLAIMER: The use of this standard is governed by the "Texas Engineering Practice Act". No warranty of any kind is made by TxDOT for any purpose whatsoever. TxDOT assumes no responsibility for the conversion of this standard to other formats or for incorrect results or damages resulting from its use.



### REQUIREMENTS FOR RED BACKGROUND REGULATORY SIGNS

(STOP, YIELD, DO NOT ENTER AND WRONG WAY SIGNS)

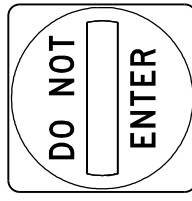
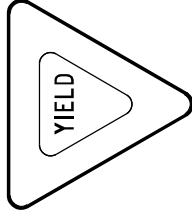
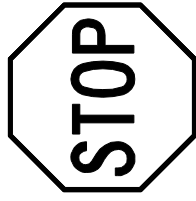

#### REQUIREMENTS FOR FOUR SPECIFIC SIGNS ONLY

SHEETING REQUIREMENTS		SIGN FACE MATERIAL
USAGE	COLOR	TYPE B OR C SHEETING
BACKGROUND	RED	TYPE B OR C SHEETING
BACKGROUND	WHITE	TYPE B OR C SHEETING
LEGEND & BORDERS	WHITE	TYPE B OR C SHEETING
LEGEND	RED	TYPE B OR C SHEETING

### REQUIREMENTS FOR WARNING SIGNS

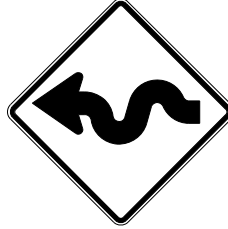
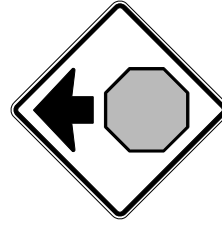

#### TYPICAL EXAMPLES

SHEETING REQUIREMENTS		SIGN FACE MATERIAL
USAGE	COLOR	TYPE B <sub>FL</sub> OR C <sub>FL</sub> SHEETING
BACKGROUND	FLOURESCENT YELLOW	ACRYLIC NON-REFLECTIVE FILM
LEGEND & BORDERS	BLACK	TYPE B OR C SHEETING
LEGEND & SYMBOLS	ALL OTHER	TYPE B OR C SHEETING

### REQUIREMENTS FOR WHITE BACKGROUND REGULATORY SIGNS

(EXCLUDING STOP, YIELD, DO NOT ENTER AND WRONG WAY SIGNS)

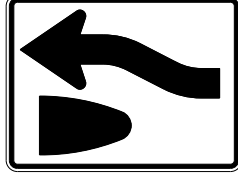
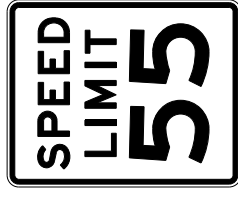

#### TYPICAL EXAMPLES

SHEETING REQUIREMENTS		SIGN FACE MATERIAL
USAGE	COLOR	TYPE A SHEETING
BACKGROUND	WHITE	TYPE B OR C SHEETING
BACKGROUND	ALL OTHERS	ACRYLIC NON-REFLECTIVE FILM
LEGEND,BORDERS AND SYMBOLS	BLACK	TYPE B OR C SHEETING
LEGEND,BORDERS AND SYMBOLS	ALL OTHER	TYPE B OR C SHEETING

### REQUIREMENTS FOR SCHOOL SIGNS



#### TYPICAL EXAMPLES

SHEETING REQUIREMENTS		SIGN FACE MATERIAL
USAGE	COLOR	TYPE B <sub>FL</sub> OR C <sub>FL</sub> SHEETING
BACKGROUND	WHITE	ACRYLIC NON-REFLECTIVE FILM
BACKGROUND	FLOURESCENT YELLOW GREEN	TYPE B OR C SHEETING
LEGEND,BORDERS AND SYMBOLS	BLACK	TYPE B OR C SHEETING
SYMBOLS	RED	TYPE B OR C SHEETING

### GENERAL NOTES

- Signs to be furnished shall be as detailed elsewhere in the plans and/or as shown on sign tabulation sheet. Standard sign designs and arrow dimensions can be found in the "Standard Highway Sign Designs for Texas" (SHSD).
- Sign legend shall use the Federal Highway Administration (FHWA) Standard Highway Alphabets (B, C, D, E, Emod or F).
- Lateral spacing between letters and numerals shall conform with the SHSD, and any approved changes thereto. Lateral spacing of legend shall provide a balanced appearance when spacing is not shown.
- Black legend and borders shall be applied by screening process or cut-out acrylic non-reflective black film to background sheeting, or combination thereof.
- White legend and borders shall be applied by screening process with transparent colored ink, transparent colored overlay film to white background sheeting or cut-out white sheeting to colored background sheeting, or combination thereof.
- Colored legend shall be applied by screening process with transparent colored ink, transparent colored overlay film or colored sheeting to background sheeting, or combination thereof.
- Sign substrate shall be any material that meets the Departmental Material Specification requirements of DMS-7110 or approved alternative.
- Mounting details for roadside mounted signs are shown in the "SMD series" Standard Plan Sheets.

ALUMINUM SIGN BLANKS THICKNESS	
Square Feet	Minimum Thickness
Less than 7.5	0.080
7.5 to 15	0.100
Greater than 15	0.125

DEPARTMENTAL MATERIAL SPECIFICATIONS	
ALUMINUM SIGN BLANKS	DMS-7110
SIGN FACE MATERIALS	DMS-8300

The Standard Highway Sign Designs for Texas (SHSD) can be found at the following website:

<http://www.txdot.gov/>

Texas Department of Transportation

Traffic Operations Division Standard

## TYPICAL SIGN REQUIREMENTS

# TSR(4) - 13

FILE:	tsr4-13.dgn	DN:	TxDOT	CK:	TxDOT	DW:	TxDOT
CONT:	October 2003	SECT:	001	JOB:	US0075	HIGHWAY:	
REV:	12-03	REV:	7-13	DIST:		COUNTY:	
9-08		DAL:		COLLIN:		SHEET NO.:	7

**ARROW DETAILS**  
for Large Ground-Mounted and Overhead Guide Signs

Type A

Type B

E-3

E-4

Down Arrow

TYPE	LETTER SIZE	USE
A-1	10.67" U/L and 10" Caps	Single Lane Exits
A-2	13.33" U/L and 12" Caps	Single Lane Exits
A-3	16" & 20" U/L	Multiple Lane Exits
B-1	10.67" U/L and 10" Caps	Multiple Lane Exits
B-2	13.33" U/L and 12" Caps	Multiple Lane Exits
B-3	16" & 20" U/L	Multiple Lane Exits

CODE	USED ON SIGN NO.
E-3	E5-1aT
E-4	E5-1bT

**NOTE**

Arrow dimensions are shown in the "Standard Highway Sign Designs for Texas" manual.

The Standard Highway Sign Designs for Texas (SHSD) can be found at the following website:  
<http://www.txdot.gov/>

**SIGN BLANK PUNCHING DETAILS FOR ATTACHMENTS WHEN SPECIFIED TO BE TYPE A ALUMINUM SIGNS (FOR MOUNTING TO GUIDE SIGN FACE)**

INTERSTATE ROUTE MARKERS

A	C	D	E
36	21	15	1 1/2
48	28	20	1 3/4

U.S. ROUTE MARKERS

Sign Size	"Y"
24x24	2
30x24	3
36x36	3
45x36	4
48x48	4
60x48	5

STATE ROUTE MARKERS

No. of Digits	W	X
4	24	4
4	36	5
4	48	6
3	24	3
3	36	4
3	48	5

**INTERSTATE ROUTE MARKERS**

**U.S. ROUTE MARKERS**

**STATE ROUTE MARKERS**

**MOUNTING DETAILS OF ATTACHMENTS TO GUIDE SIGN FACE ("EXIT ONLY" AND "LEFT EXIT" PANELS, ROUTE MARKERS AND OTHER ATTACHMENTS)**

DIRECT APPLIED ATTACHMENT

SCREW ATTACHMENT

NOTE:  
1. Sheeting for legend, symbols, and borders must be cut at panel joints.  
2. Direct applied attachment signs will be subsidiary to "Aluminum Signs" or "Fiberglass Signs".

NUT/BOLT ATTACHMENT

ARROW DETAILS  
for Destination Signs (Type D)

Standard arrow to be used with 8 inch letters.

Standard arrow to be used with 6 inch letters.

NOTE:  
Furnish Type A aluminum sign attachments only when specified in the plans. These signs will be paid for under "Aluminum Signs".

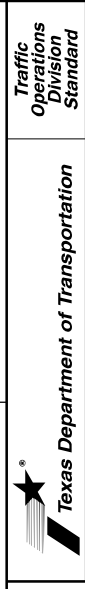

**TYPICAL SIGN REQUIREMENTS**

**TSR(5) - 13**

FILE: tsr5-13.dgn	DNK: TXDOT	CK: TXDOT	DW: TXDOT	CK: TXDOT
October 2003	CONT: SECT	JOB: HIGHWAY	US0075	
REVISIONS: 6465 17 001	DST: COUNTY	COUNTY: COLLIN	SHEET NO: 8	
12-03 9-08				

DISCLAIMER: The use of this standard is governed by the "Texas Engineering Practice Act". No warranty of any kind is made by TXDOT for any purpose whatsoever. TXDOT assumes no responsibility for the conversion of this standard to other formats or for incorrect results or damages resulting from its use.

**BARRICADE AND CONSTRUCTION (BC) STANDARD SHEETS GENERAL NOTES:**

1. The Barricade and Construction Standard Sheets (BC sheets) are intended to show typical examples for placement of temporary traffic control devices, construction pavement markings, and typical work zone signs. The information contained in these sheets meet or exceed the requirements shown in the "Texas Manual on Uniform Traffic Control Devices" (TMUTCD).
2. The development and design of the Traffic Control Plan (TCP) is the responsibility of the Engineer.
3. The Contractor may propose changes to the TCP that are signed and sealed by a licensed professional engineer for approval. The Engineer may develop, sign and seal Contractor proposed changes.
4. The Contractor is responsible for installing and maintaining the traffic control devices as shown in the plans. The Contractor may not move or change the approximate location of any device without the approval of the Engineer.
5. Geometric design of lane shifts and detours should, when possible, meet the applicable design criteria contained in manuals such as the American Association of State Highway and Transportation Officials (AASHTO), "A Policy on Geometric Design of Highways and Streets," the TxDOT "Roadway Design Manual" or engineering judgment.
6. When projects about, the Engineer(s) may omit the END ROAD WORK, TRAFFIC FINES DOUBLE, and other advance warning signs if the signing would be redundant and the work areas appear continuous to the motorists. If the adjacent project is completed first, the Contractor shall erect the necessary warning signs as shown on these sheets, the TCP sheets or as directed by the Engineer. The BEGIN ROAD WORK NEXT X MILES sign shall be revised to show appropriate work zone distance.
7. The Engineer may require duplicate warning signs on the median side of divided highways where median width will permit and traffic volumes justify the signing.
8. All signs shall be constructed in accordance with the details found in the "Standard Highway Sign Designs for Texas," latest edition. Sign details not shown in this manual shall be shown in the plans or the Engineer shall provide a detail to the Contractor before the sign is manufactured.
9. The temporary traffic control devices shown in the illustrations of the BC sheets are examples. As necessary, the Engineer will determine the most appropriate traffic control devices to be used.
10. Where highway construction or maintenance work is being undertaken, other than mobile operations as defined by the Texas Manual on Uniform Traffic Control Devices, CSJ limit signs are required. CSJ limit signs are shown on BC(2). The OBEY WARNING SIGNS STATE LAW sign, STAY ALERT TALK OR TEXT LATER and the WORK ZONE TRAFFIC FINES DOUBLE sign with plaque shall be erected in advance of the CSJ limits. The BEGIN ROAD WORK NEXT X MILES, CONTRACTOR and END ROAD WORK signs shall be erected at or near the CSJ limits. For mobile operations, CSJ limit signs are not required.
11. Traffic control devices should be in place only while work is actually in progress or a definite need exists.
12. The Engineer has the final decision on the location of all traffic control devices.
13. Inactive equipment and work vehicles, including workers' private vehicles must be parked away from travel lanes. They should be as close to the right-of-way line as possible, or located behind a barrier or guardrail, or as approved by the Engineer.

**WORKER SAFETY NOTES:**

1. Workers on foot who are exposed to traffic or to construction equipment within the right-of-way shall wear high-visibility safety apparel meeting the requirements of ISEA "American National Standard for High-Visibility Apparel," or equivalent revisions, and labeled as ANSI 107-2004 standard performance for Class 2 or 3 risk exposure. Class 3 garments should be considered for high traffic volume work areas or night time work.
2. Except in emergency situations, flagger stations shall be illuminated when flagging is used at night.

**COMPLIANT WORKZONE TRAFFIC CONTROL DEVICES**

1. Only pre-qualified products shall be used. The "Compliant Work Zone Traffic Control Devices List" (CWZTCD) describes pre-qualified products and their sources.
2. Work zone traffic control devices shall be compliant with the Manual for Assessing safety Hardware (MASH).

THE DOCUMENTS BELOW CAN BE FOUND ON-LINE AT <a href="http://www.txdot.gov">http://www.txdot.gov</a>
COMPLIANT WORK ZONE TRAFFIC CONTROL DEVICES LIST (CWZTCD)
DEPARTMENTAL MATERIAL SPECIFICATIONS (DMS)
MATERIAL PRODUCER LIST (MPL)
ROADWAY DESIGN MANUAL - SEE "MANUALS (ONLINE MANUALS)"
STANDARD HIGHWAY SIGN DESIGNS FOR TEXAS (SHSD)
TEXAS MANUAL ON UNIFORM TRAFFIC CONTROL DEVICES (TMUTCD)
TRAFFIC ENGINEERING STANDARD SHEETS

DISCLAIMER: The use of this standard is governed by the "Texas Engineering Practice Act". No warranty of any kind is made by TxDOT for any purpose whatsoever. TxDOT assumes no responsibility for the conversion of this standard to other formats or for incorrect results or damages resulting from its use.

 <b>Texas Department of Transportation</b>	<b>Traffic Safety Division Standard</b>			
	<b>BARRICADE AND CONSTRUCTION GENERAL NOTES AND REQUIREMENTS</b>	<b>BC(1) - 21</b>		
FILE: bc-21.dgn © TxDOT November 2002	DW: TxDOT 4-03 7-13 9-07 8-14 5-10 5-21	CK: TxDOT CONT SECT 6465 17 001	JOB US0075	HWY HIGHWAY
	DIST COUNTY	DAL COLLIN	SHEET NO. 9	SHEET NO. 9

TYPICAL LOCATION OF CROSSROAD SIGNS

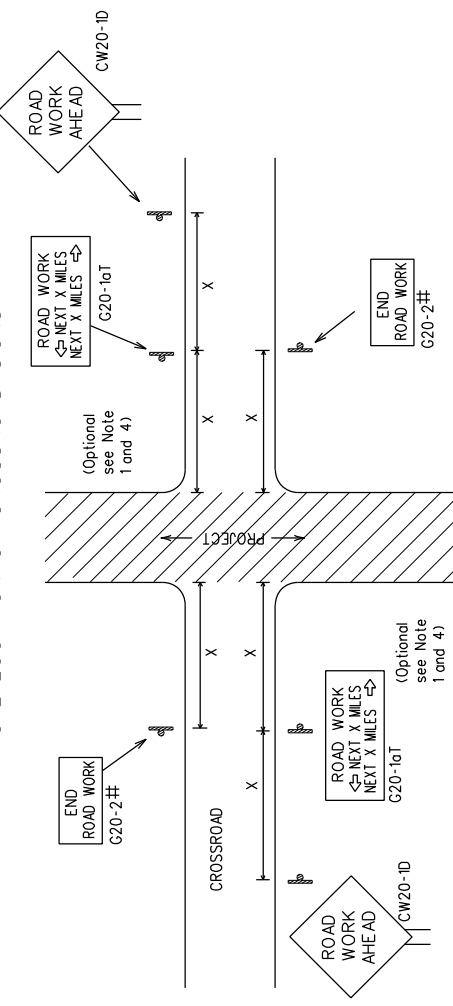

# May be mounted on back of "ROAD WORK AHEAD"(CW20-1D) sign with approval of Engineer. (See note 2 below)

- The typical minimum signing on a crossroad approach should be a "ROAD WORK AHEAD" (CW20-1D) sign and a (G20-2) "END ROAD WORK" sign, unless noted otherwise in plans.
- The Engineer may use the reduced size 36" x 36" ROAD WORK AHEAD (CW20-1D) sign on low volume crossroads (see Note 4 under with the reduced size 36" x 18" "END ROAD WORK"(G20-2) sign on low volume crossroads (see Note 4 under "Typical Construction Warning Sign Size and Spacing"). See the "Standard Highway Sign Designs for Texas" manual for sign details. The Engineer may omit the advance warning signs on low volume crossroads. The Engineer will determine whether a road is low volume as per TMUTCD Part 5. This information shall be shown in the plans.
- Based on existing field conditions, the Engineer/Inspector may require additional signs such as FLAGGER AHEAD, LOOSE GRAVEL, or other appropriate signs. When additional signs are required, these signs will be considered part of the minimum requirements. The Engineer/Inspector will determine the proper location and spacing of any sign not shown on the BC sheets, Traffic Control Plan sheets or the Work Zone Standard Sheets.
- The "ROAD WORK NEXT X MILES"(G20-1aT) sign shall be required at high volume crossroads to advise motorists of the length of construction in either direction from the intersection. The Engineer will determine whether a roadway is considered high volume.
- Additional traffic control devices may be shown elsewhere in the plans for higher volume crossroads.
- When work occurs in the intersection area, appropriate traffic control devices, as shown elsewhere in the plans or as determined by the Engineer/Inspector, shall be in place.

T-INTERSECTION

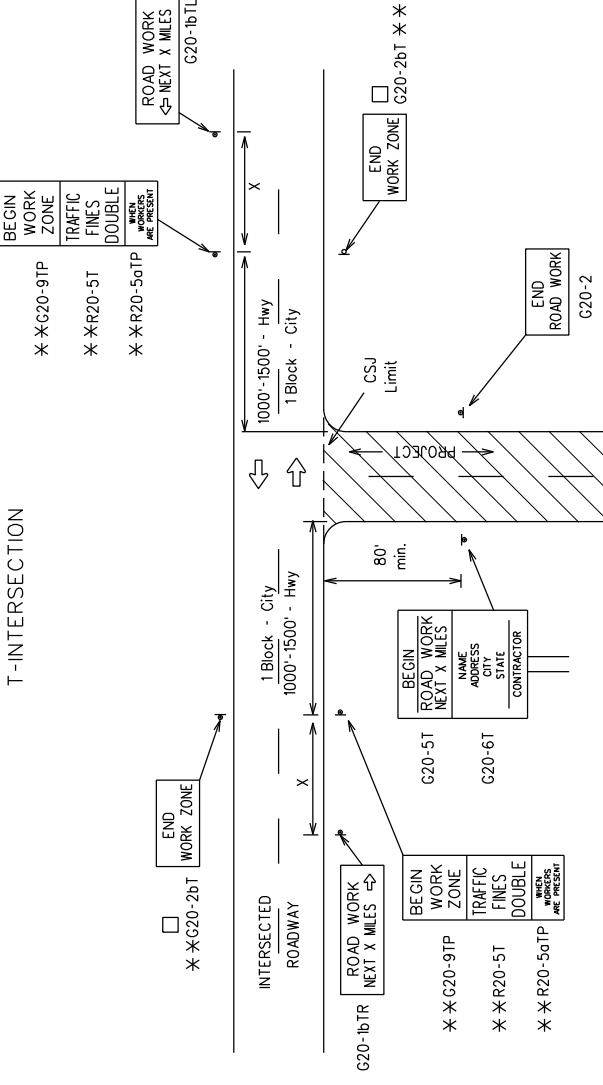

CSJ LIMITS AT T-INTERSECTION

- The Engineer will determine the types and location of any additional traffic control devices, such as a flagger and accompanying signs, or other signs, that should be used when work is being performed at or near an intersection.
- If construction closes the road at a T-intersection, the Contractor shall place the "CONTRACTOR NAME"(G20-6T) sign behind the Type 3 Barricades for the road closure (see BC(10) also). The "ROAD WORK NEXT X MILES"(G20-1bTL) and "ROAD WORK NEXT X MILES" right arrow (G20-1bTR) signs shall be replaced by the detour signing called for in the plans.

TYPICAL CONSTRUCTION WARNING SIGN SIZE AND SPACING

Sign Number or Series	SIZE		Expressway/Freeway	Posted Speed	Sign Spacing "X"
	Conventional Road	Expressway/Freeway			
CW20 <sup>4</sup>				MPH	Feet (Apprx.)
CW21	48" x 48"	48" x 48"		30	120
CW22				35	160
CW23				40	240
CW25				45	320
CW1, CW2, CW7, CW8, CW9, CW11, CW14	36" x 36"	48" x 48"		50	400
				55	500
				60	600
				65	700
				70	800
				75	900
				80	1000
				*	*
					3

\* For typical sign spacings on divided highways, expressways and freeways, see Part 6 of the "Texas Manual on Uniform Traffic Control Devices" (TMUTCD) typical application diagrams or TCP Standard Sheets.

\* Minimum distance from work area to first Advance Warning sign nearest the work area and/or distance between each additional sign.

GENERAL NOTES

- Special or larger size signs may be used as necessary.
- Distance between signs should be increased as required to have 1500 feet advance warning.
- Distance between signs should be increased as required to have 1/2 mile or more advance warning.
- 36" x 36" "ROAD WORK AHEAD" (CW20-1D) signs may be used on low volume crossroads at the discretion of the Engineer as per TMUTCD Part 5. See Note 2 under "Typical Location of Crossroad Signs".
- Only diamond shaped warning sign sizes are indicated.
- See sign size listing in "TMUTCD", Sign Appendix or the "Standard Highway Sign Designs for Texas" manual for complete list of available sign design sizes.

WORK AREAS IN MULTIPLE LOCATIONS WITHIN CSJ LIMITS

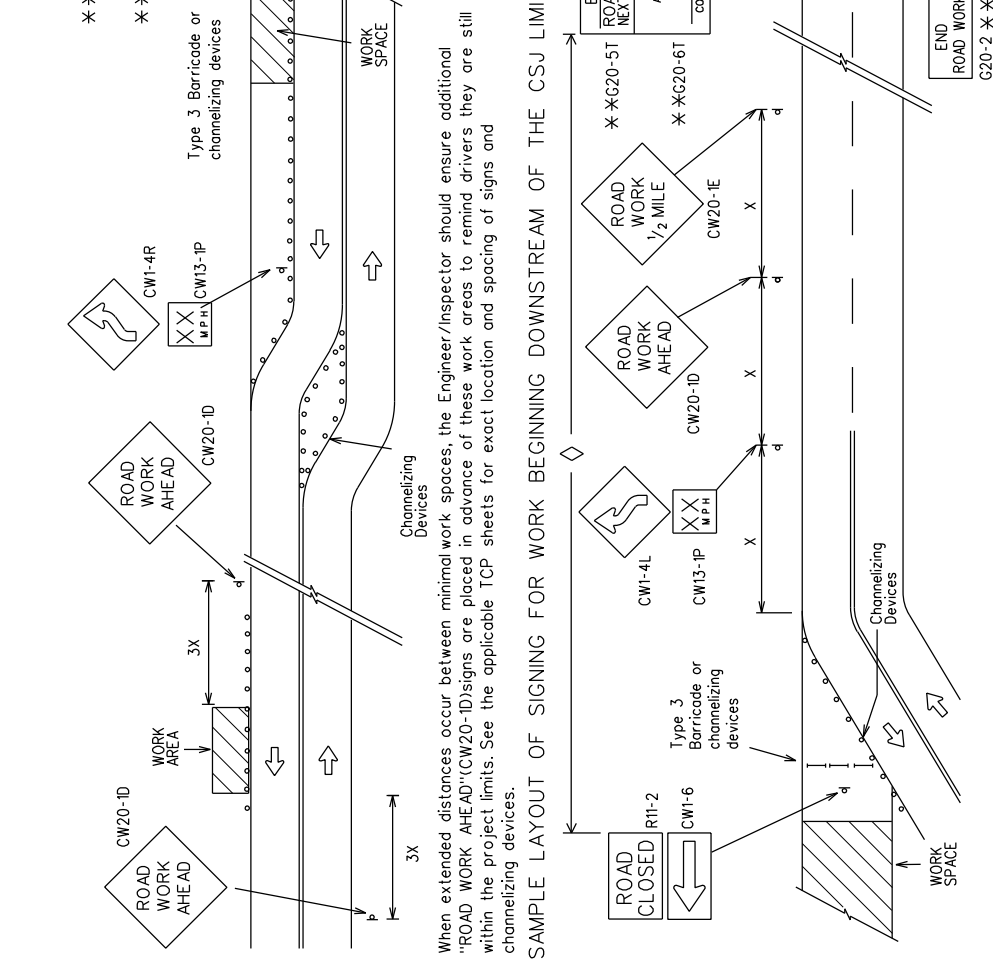

When extended distances occur between minimal work spaces, the Engineer/Inspector should ensure additional "ROAD WORK AHEAD"(CW20-1D) signs are placed in advance of these work areas to remind drivers they are still within the project limits. See the applicable TCP sheets for exact location and spacing of signs and channelizing devices.

SAMPLE LAYOUT OF SIGNING FOR WORK BEGINNING DOWNSTREAM OF THE CSJ LIMITS

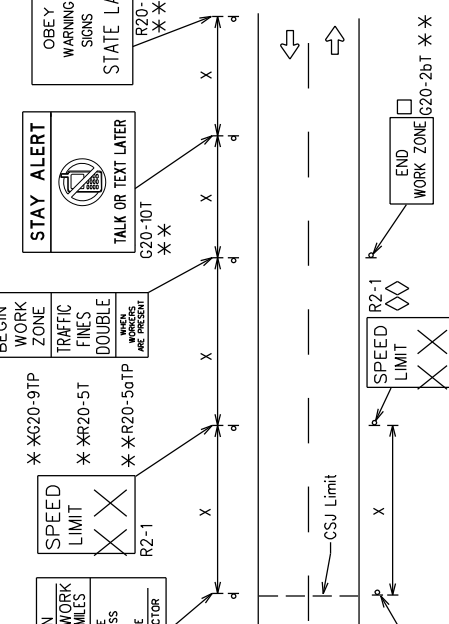

SAMPLE LAYOUT OF SIGNING FOR WORK BEGINNING AT THE CSJ LIMITS

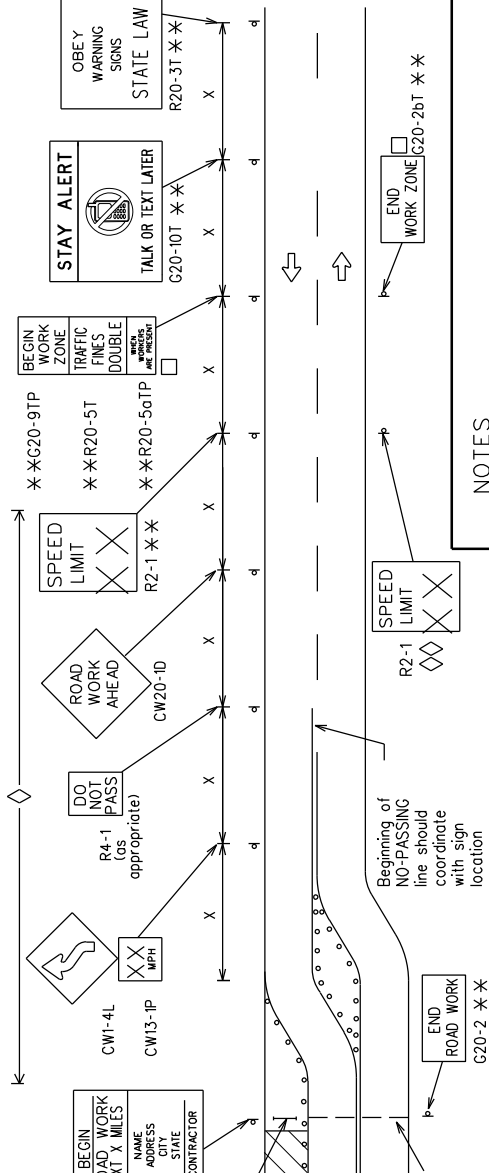

NOTES

- The Contractor shall determine the appropriate distance to be placed on the G20-1 series signs and "BEGIN ROAD WORK NEXT X MILES"(G20-5T) sign for each specific project. This distance shall replace the "X" and shall be rounded to the nearest whole mile with the approval of the Engineer. No decimals shall be used.
- The "BEGIN WORK ZONE"(G20-9TP) and "END WORK ZONE" (G20-2bT) shall be used as shown on the sample layout when advance signs are required outside the CSJ Limits. They inform the motorist of entering or leaving a part of the work zone lying outside the CSJ Limits where traffic fines may double if workers are present.
- CSJ limit signing is required for highway construction and maintenance work, with the exception of mobile operations.
- Area for placement of "ROAD WORK AHEAD" (CW20-1D) sign and other signs or devices as called for on the Traffic Control Plan.
- Contractor will install a regulatory speed limit sign at the end of the work zone.

LEGEND	
— —	Type 3 Barricade
○ ○ ○	Channelizing Devices
— —	Sign
X	See Typical Construction Warning Sign Size and Spacing chart or the TMUTCD for sign spacing requirements.

SHEET 2 OF 12



BARRICADE AND CONSTRUCTION PROJECT LIMIT

BC(2)-21

FILE:	bc-21.dgn	DATE:	10/01/02	BY:	ck
REVISED:	November 2002	JOB NO.:	US0075	COUNTY:	
DATE:	9-07	DIST.:	7-13	COLL. NO.:	10

# TYPICAL APPLICATION OF WORK ZONE SPEED LIMIT SIGNS

Work zone speed limits shall be regulatory, established in accordance with the "Procedures for Establishing Speed Zones," and approved by the Texas Transportation Commission, or by City Ordinance when within Incorporated City Limits.

Reduced speeds should only be posted in the vicinity of work activity and not throughout the entire project. Regulatory work zone speed signs (R2-1) shall be removed or covered during periods when they are not needed.

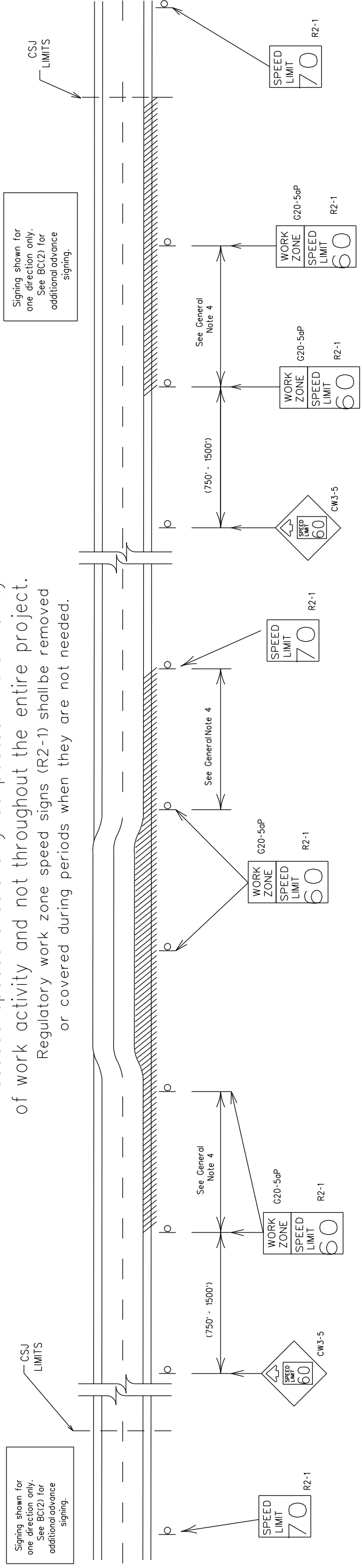

## GUIDANCE FOR USE:

### LONG/INTERMEDIATE TERM WORK ZONE SPEED LIMITS

This type of work zone speed limit should be included on the design of the traffic control plans when restricted geometrics with a lower design speed are present in the work zone and modification of the geometrics to a higher design speed is not feasible.

Long/Intermediate Term Work Zone Speed Limit signs, when approved as described above, should be posted and visible to the motorist when work activity is present. Work activity may also be defined as a change in the roadway that requires a reduced speed for motorists to safely negotiate the work area, including:

- a) rough road or damaged pavement surface
- b) substantial alteration of roadway geometrics (diversions)
- c) construction detours
- d) grade
- e) width
- f) other conditions readily apparent to the driver

As long as any of these conditions exist, the work zone speed limit signs should remain in place.

### SHORT TERM WORK ZONE SPEED LIMITS

This type of work zone speed limit may be included on the design of the traffic control plans when workers or equipment are not behind concrete barrier, when work activity is within 10 feet of the traveled way or actually in the traveled way.

Short Term Work Zone Speed Limit signs should be posted and visible to the motorists only when work activity is present. When work activity is not present, signs shall be removed or covered. (See Removing or Covering on BC(4)).

## GENERAL NOTES

1. Regulatory work zone speed limits should be used only for sections of construction projects where speed controls of major importance.
2. Regulatory work zone speed limit signs shall be placed on supports at a 7 foot minimum mounting height.
3. Speed zone signs are illustrated for one direction of travel and are normally posted for each direction of travel.
4. Frequency of work zone speed limit signs should be:
  - 40 mph and greater 0.2 to 2 miles
  - 35 mph and less 0.2 to 1 mile
5. Regulatory speed limit signs shall have black legend and border on a white reflective background (See "Reflective Sheeting" on BC(4)).
6. Fabrication, erection and maintenance of the "ADVANCE SPEED LIMIT" (CW3-5) sign, "WORK ZONE" (G20-5aP) plaque and the "SPEED LIMIT" (R2-1) signs shall not be paid for directly, but shall be considered subsidiary to Item 502.
7. Turning signs from view, laying signs over or down will not be allowed, unless as otherwise noted under "REMOVING OR COVERING" on BC(4).
8. Techniques that may help reduce traffic speeds include but are not limited to:
  - A. Low enforcement.
  - B. Flagger stationed next to sign.
  - C. Portable changeable message sign (PCMS).
  - D. Low-power (drone) radar transmitter.
  - E. Speed monitor trailers or signs.
9. Speeds shown on details above are for illustration only. Work Zone Speed Limits should only be posted as approved for each project.
10. For more specific guidance concerning the type of work, work zone conditions and factors impacting allowable regulatory construction speed zone reduction see TxDOT form #1204 in the TxDOT e-form system.

		<b>Texas Department of Transportation</b>	
<b>BARRICADE AND CONSTRUCTION WORK ZONE SPEED LIMIT</b>			
<b>BC(3) - 21</b>			
FILE:	bc-21.dgn	CK: TxDOT	OW: TxDOT
DATE:	November 2002	CONT: 6465	SECT: 17
REVISIONS:	8-14	JOB: 001	HIGHWAY: US0075
7-13	5-21	DIST: COUNTY	SHEET NO. COLLIN
97			11

TYPICAL MINIMUM CLEARANCES FOR LONG TERM AND INTERMEDIATE TERM SIGNS

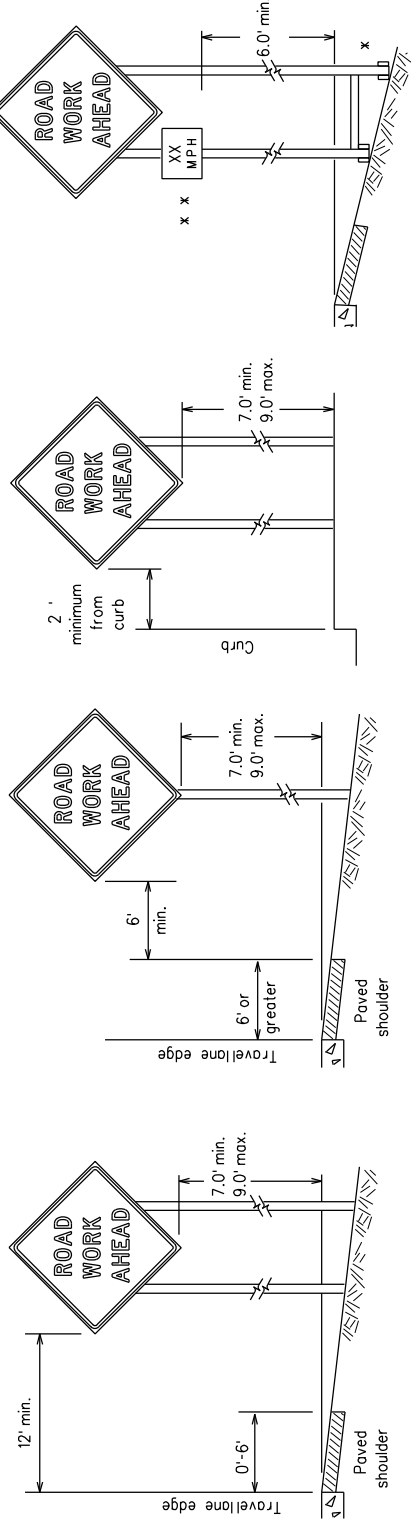

x When placing skid supports on uneven ground, the leg post lengths must be adjusted so the sign appears straight and plumb. Objects shall NOT be placed under skids as a means of leveling.

x x When plaques are placed on dual-leg supports, they should be attached to the upright nearest the travel lane. Supplemental plaques (advisory or distance) should not cover the surface of the parent sign.

ATTACHMENT FOR SIGN SUPPORTS

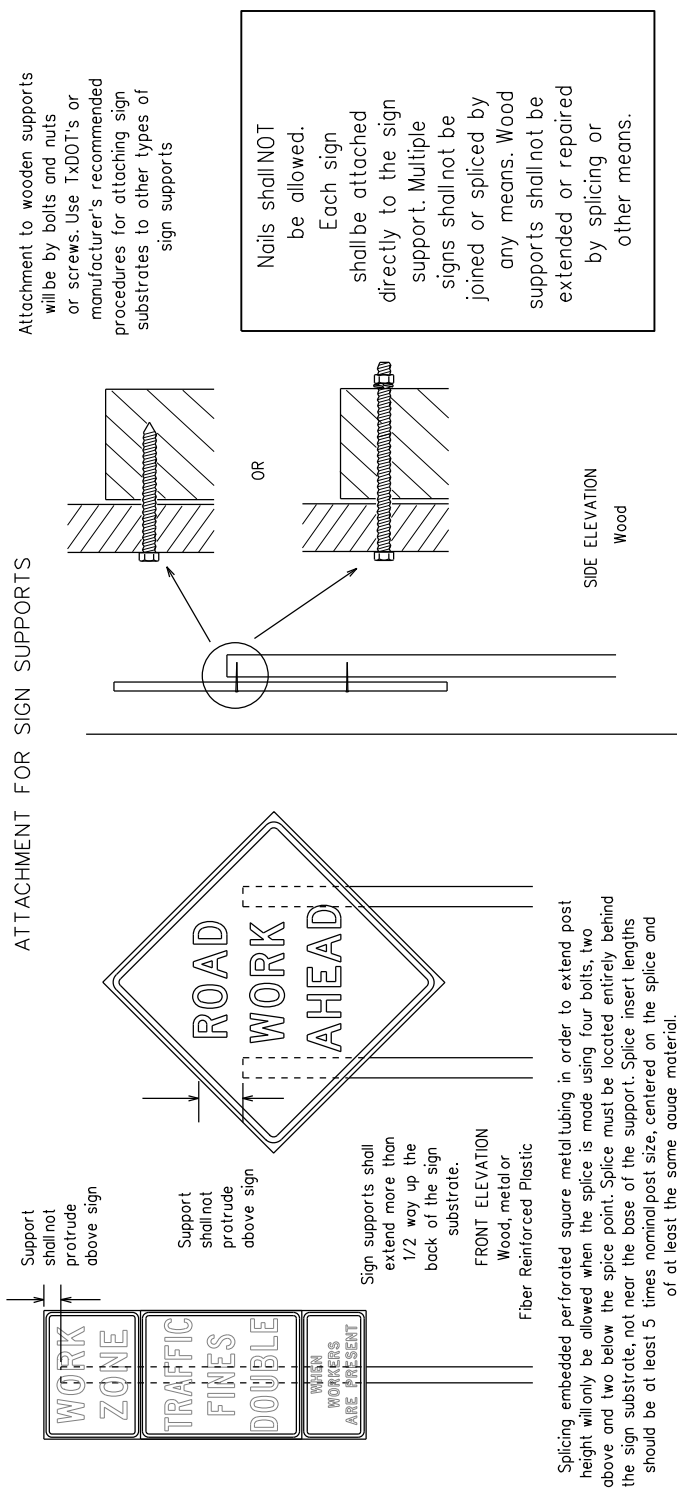

Splicing embedded perforated square metal tubing in order to extend post height will only be allowed when the splice is made using four bolts, two above and two below the splice point. Splice must be located entirely behind the sign substrate, not near the base of the support. Splice insert lengths should be at least 5 times nominal post size, centered on the splice and of at least the same gauge material.

STOP/SLOW PADDLES

1. STOP/SLOW paddles are the primary method to control traffic by flaggers. The STOP/SLOW paddle size should be 24" x 24".
2. STOP/SLOW paddles shall be retroreflective when used at night.
3. STOP/SLOW paddles may be attached to a staff with a minimum length of 6" to the bottom of the sign.
4. Any lights incorporated into the STOP or SLOW paddle faces shall only be as specifically described in Section 6E.03 Hand Signaling Devices in the TMUTCD.

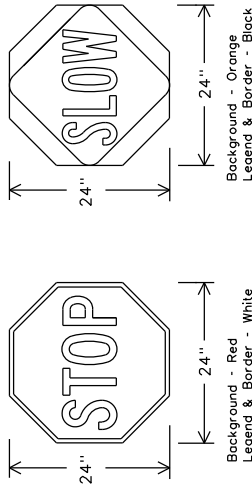

SHEETING REQUIREMENTS (WHEN USED AT NIGHT)	
USAGE	SIGN FACE MATERIAL
BACKGROUND	TYPE B OR C SHEETING
BACKGROUND	TYPE B <sub>FL</sub> OR C <sub>FL</sub> SHEETING
LEGEND & BORDER	TYPE B OR C SHEETING
LEGEND & BORDER	BLACK ACRYLIC NON-REFLECTIVE FILM

CONTRACTOR REQUIREMENTS FOR MAINTAINING PERMANENT SIGNS WITHIN THE PROJECT LIMITS

1. Permanent signs are used to give notice of traffic laws or regulations, call attention to conditions that are potentially hazardous to traffic operations, show route designations, destinations, directions, distances, services, points of interest, and other geographical, recreational, specific service (LOGO), or cultural information. Drivers proceeding through a work zone need the same, if not better route guidance as normally installed on a roadway without construction.
2. When permanent regulatory or warning signs conflict with work zone conditions, remove or cover the permanent signs until the permanent sign message matches the roadway condition. For details for covering large guide signs see the TS-CD standard.
3. When existing permanent signs are moved and relocated due to construction purposes, they shall be visible to motorists at all times.
4. If existing signs are to be relocated on their original supports, they shall be installed on crashworthy bases as shown on the SMD Standard sheets. The signs shall meet the required mounting heights shown on the BC Sheets or the SMD Standards. This work should be paid for under the appropriate pay item for relocating existing signs.
5. If permanent signs are to be removed and relocated using temporary supports, the Contractor shall use crashworthy supports as shown on the BC standard sheets, TLRS standard sheets or the CWZTCD list. The signs shall meet the required mounting heights shown on the BC, or the SMD standard sheets during construction. This work should be paid for under the appropriate pay item for relocating existing signs.
6. Any sign or traffic control device that is struck or damaged by the Contractor or his/her construction equipment shall be replaced as soon as possible by the Contractor to ensure proper guidance for the motorists. This will be subsidiary to item 502.

GENERAL NOTES FOR WORK ZONE SIGNS

1. Contractor shall install and maintain signs in a straight and plumb condition and/or as directed by the Engineer.
2. Wooden sign posts shall be painted white.
3. Barricades shall NOT be used as sign supports.
4. All signs shall be installed in accordance with the plans or as directed by the Engineer. Signs shall be used to regulate, warn, and guide the traveling public safely through the work zone.
5. The Contractor may furnish either the sign design shown in the plans or in the "Standard Highway Sign Designs for Texas" (SHSD). The Engineer/Inspector may require the Contractor to furnish other work zone signs that are shown in the TMUTCD but may have been omitted from the plans. Any variation in the plans shall be documented by written agreement between the Engineer and the Contractor's Responsible Person. All changes must be documented in writing before being implemented. This can include documenting the changes in the Inspector's TXDOT diary and having both the Inspector and Contractor initial and date the agreed upon changes.
6. The Contractor shall furnish sign supports listed in the "Compliant Work Zone Traffic Control Device List" (CWZTCD) for small roadside signs. Supports for temporary large roadside signs shall meet the requirements detailed on the Temporary Large Roadside Signs (TLRS) regarding installation procedures. The Contractor shall install the sign support in accordance with the manufacturer's recommendations. If there is a question the Engineer can verify the correct procedures are being followed.
7. The Contractor is responsible for installing signs on approved supports and replacing signs with damaged or cracked substrates and/or damaged or marred reflective sheeting as directed by the Engineer/Inspector.
8. Identification markings may be shown only on the back of the sign substrate. The maximum height of letters and/or company logos used for identification shall be 1 inch.
9. The Contractor shall replace damaged wood posts. New or damaged wood sign posts shall not be spliced.

DURATION OF WORK (as defined by the "Texas Manual on Uniform Traffic Control Devices" Part 6)

1. The types of sign supports, sign mounting height, the size of signs, and the type of sign substrates can vary based on the type of work being performed. The Engineer is responsible for selecting the appropriate size sign for the type of work being performed. The Contractor is responsible for ensuring the sign support, sign mounting height and substrate meets manufacturer's recommendations in regard to crashworthiness and duration of work requirements.

- a. Long-term stationary - work that occupies a location more than 3 days.
- b. Intermediate-term stationary - work that occupies a location more than one daylight period up to 3 days, or nighttime work lasting more than one hour.
- c. Short-term stationary - daytime work that occupies a location for more than 1 hour in a single daylight period.
- d. Short, duration - work that occupies a location up to 1 hour.
- e. Mobile - work that moves continuously or intermittently (stopping for up to approximately 15 minutes.)

SIGN MOUNTING HEIGHT

1. The bottom of Long-term/Intermediate-term signs shall be at least 7 feet, but not more than 9 feet, above the paved surface, except as shown for supplemental plaques mounted below other signs.
2. The bottom of Short-term/Short Duration signs shall be a minimum of 1 foot above the pavement surface but no more than 2 feet above the ground.
3. Long-term/Intermediate-term Signs may be used in lieu of Short-term/Short Duration signing.
4. Short-term/Short Duration signs shall be used only during daylight and shall be removed at the end of the workday or raised to appropriate Long-term/Intermediate sign height.
5. Regulatory signs shall be mounted at least 7 feet, but not more than 9 feet, above the paved surface regardless of work duration.

SIZE OF SIGNS

1. The Contractor shall furnish the sign sizes shown on BC (2) unless otherwise shown in the plans or as directed by the Engineer.

SIGN SUBSTRATES

1. The Contractor shall ensure the sign substrate is installed in accordance with the manufacturer's recommendations for the type of sign support that is being used. The CWZTCD lists each substrate that can be used on the different types and models of sign supports.
2. "Mesh" type materials are NOT an approved sign substrate, regardless of the tightness of the weave.
3. All wooden material sign panels fabricated from 2 or more pieces shall have one or more plywood cleat, 1/2" thick by 6" wide, fastened to the back of the sign and extending fully across the sign. The cleat shall be attached to the back of the sign using wood screws that do not penetrate the face of the sign panel. The screws shall be placed on both sides of the splice and spaced at 6" centers. The Engineer may approve other methods of splicing the sign face.

REFLECTIVE SHEETING

1. All signs shall be retroreflective and constructed of sheeting meeting the color and retro-reflectivity requirements of DMS-8300 for rigid signs or DMS-8310 for roll-up signs. The web address for DMS specifications is shown on BC(1).
2. White sheeting, meeting the requirements of DMS-8300 Type A, shall be used for signs with a white background.
3. Orange sheeting, meeting the requirements of DMS-8300 Type B or Type C, shall be used for rigid signs with orange backgrounds.

SIGN LETTERS

1. All sign letters and numbers shall be clear, and open rounded type uppercase alphabet letters as approved by the Federal Highway Administration (FHWA) and as published in the "Standard Highway Sign Design for Texas" manual. Signs, letters and numbers shall be of first class workmanship in accordance with Department Standards and Specifications.

REMOVING OR COVERING

1. When sign messages may be confusing or do not apply, the signs shall be removed or completely covered.
2. Long-term stationary or intermediate stationary signs installed on square metal tubing may be turned away from traffic 90 degrees when the sign message is not applicable. This technique may not be used for signs installed in the median of divided highways or near any intersections where the sign may be seen from approaching traffic.

3. Signs installed on wooden skids shall not be turned at 90 degree angles to the roadway. These signs should be removed or completely covered when not required.

4. When signs are covered, the material used shall be opaque, such as heavy milblack plastic, or other materials which will cover the entire sign face and maintain their opaque properties under automobile headlights at night, without damaging the sign sheeting.
5. Burlap shall NOT be used to cover signs.

6. Duct tape or other adhesive material shall NOT be affixed to a sign face.
7. Signs and anchor studs shall be removed and holes backfilled upon completion of work.

SIGN SUPPORT WEIGHTS

1. Where sign supports require the use of weights to keep from turning over, the use of sandbags with dry, cohesionless sand should be used.
2. The sandbags will be tied shut to keep the sand from spilling and to maintain a constant weight.
3. Rock, concrete, iron, steel or other solid objects shall not be permitted for use as sign support weights.
4. Sandbags should weigh a minimum of 35 lbs and a maximum of 50 lbs.
5. Sandbags shall be made of a durable material that tears upon vehicular impact. Rubber (such as tire inner tubes) shall NOT be used.
6. Rubber ballast (designed for channelizing devices) should not be used for ballast on portable sign supports. Sign supports designed and manufactured with rubber bases may be used when shown on the CWZTCD list.
7. Sandbags shall only be placed along or laid over the base supports of the traffic control device and shall not be suspended above ground level or hung with rope, wire, chains or other fasteners. Sandbags shall be placed along the length of the skids to weigh down the sign support.
8. Sandbags shall NOT be placed under the skid and shall not be used to level sign supports placed on slopes.

FLAGS ON SIGNS

1. Flags may be used to draw attention to warning signs. When used, the flag shall be 16 inches square or larger and shall be orange or fluorescent red-orange in color. Flags shall not be allowed to cover any portion of the sign face.

DISCLAIMER: The use of this standard is governed by the "Texas Engineering Practice Act". No warranty of any kind is made by TXDOT for any purpose whatsoever. TXDOT assumes no responsibility for the conversion of this standard to other formats or for incorrect results or damages resulting from its use.



**Texas Department of Transportation**

**BARRICADE AND CONSTRUCTION  
TEMPORARY SIGN NOTES**

**BC(4) - 21**

FILE:	bc-21.dgn	DATE:	TXDOT	DATE:	TXDOT	DATE:	TXDOT
CONT:	SECT	JOB:	001	REVISIONS:	US0075	DATE:	08-14
DIST:	001	COUNTY:		SHEET NO.:	7-15	COUNTY:	COLLIN
DAL:		COUNTY:		SHEET NO.:	5-21	COUNTY:	COLLIN

DISCLAIMER:  
The use of this standard is governed by the "Texas Engineering Practice Act". No warranty of any kind is made by TxDOT for any purpose whatsoever. TxDOT assumes no responsibility for the conversion of this standard to other formats or for incorrect results or damages resulting from its use.

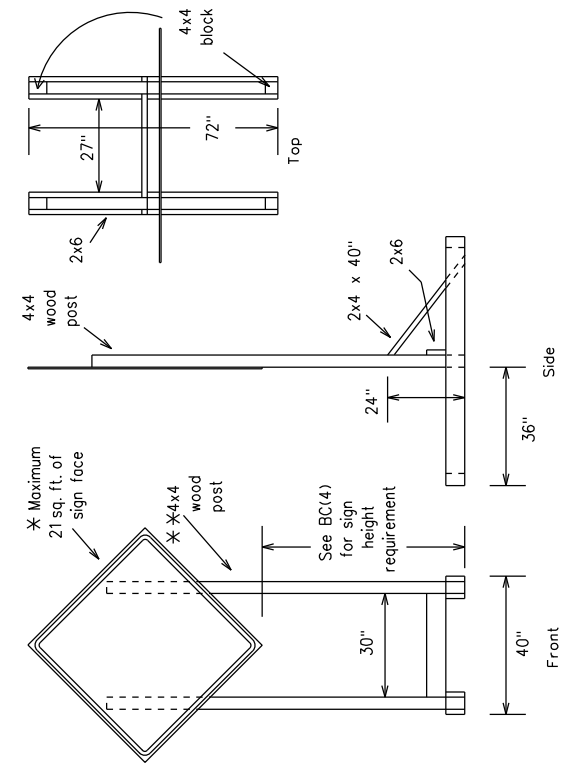

**SKID MOUNTED WOOD SIGN SUPPORTS**

\* LONG/INTERMEDIATE TERM STATIONARY - PORTABLE SKID MOUNTED SIGN SUPPORTS

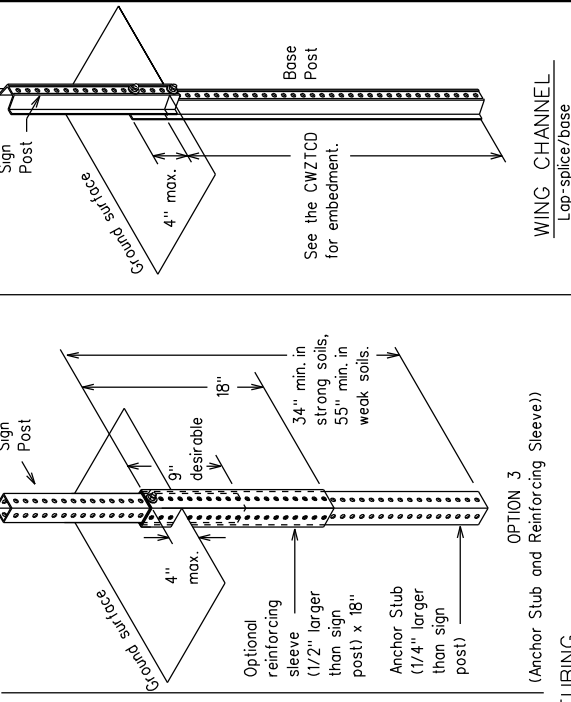
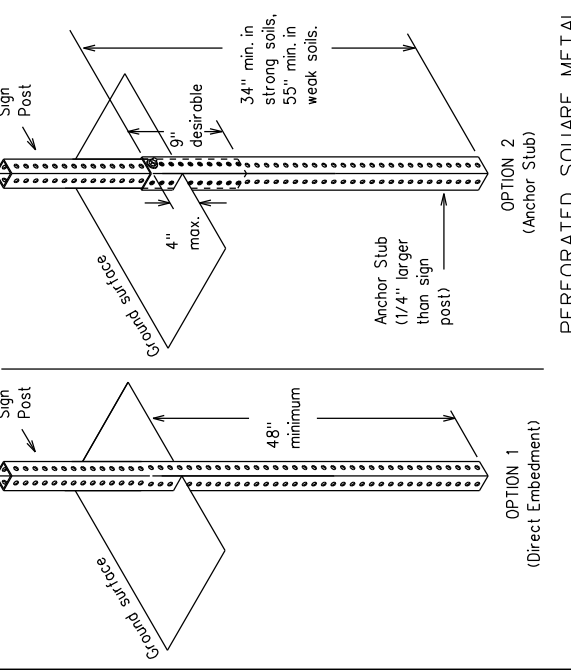
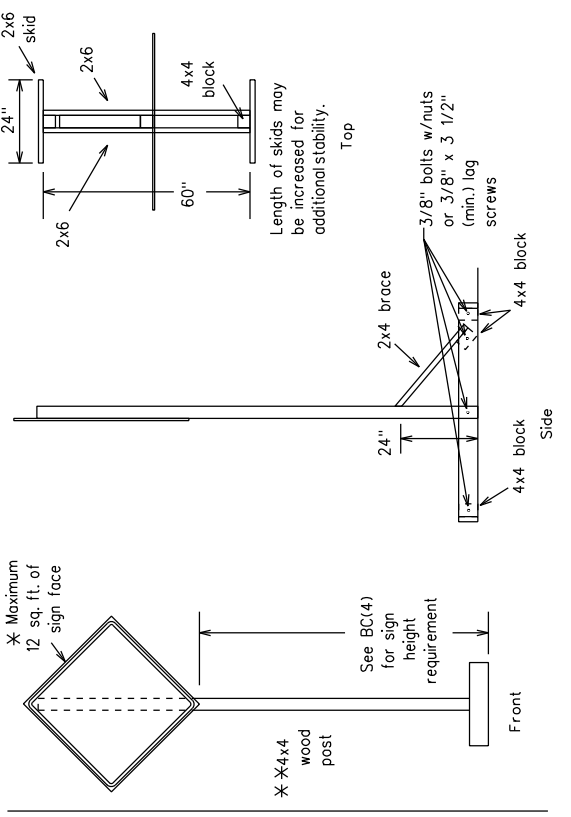

**GROUND MOUNTED SIGN SUPPORTS**

Refer to the CWZTCD and the manufacturer's installation procedure for each type sign support. The maximum sign square footage shall adhere to the manufacturer's recommendation. Two post installations can be used for larger signs.

16 sq. ft. or less of any rigid sign substrate listed in section 4.2.d of the CWZTCD, except 5/8" plywood. 1/2" plywood is allowed.

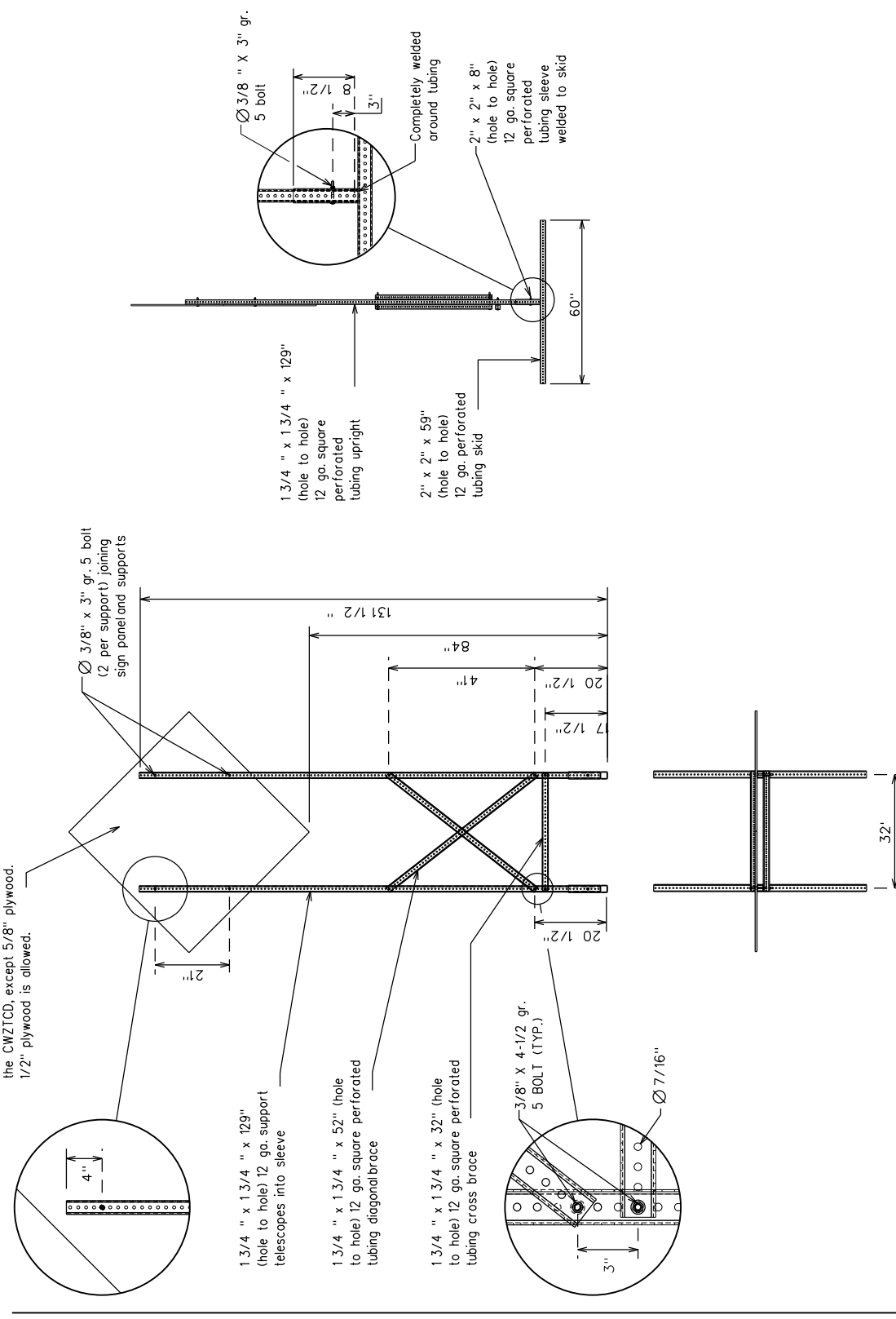

**WEDGE ANCHORS**  
Both steel and plastic Wedge Anchor Systems as shown on the SMD Standard Sheets may be used as temporary sign supports for signs up to 10 square feet of sign face. They may be set in concrete or in sturdy soils if approved by the Engineer. (See web address for "Traffic Engineering Standard Sheets" on BC(1)).

**OTHER DESIGNS**  
MORE DETAILS OF APPROVED LONG/INTERMEDIATE AND SHORT TERM SUPPORTS CAN BE FOUND ON THE CWZTCD LIST. SEE BC(1) FOR WEBSITE LOCATION.

**GENERAL NOTES**

- Nails may be used in the assembly of wooden sign supports, but 3/8" bolts with nuts or 3/8" x 3 1/2" lag screws must be used on every joint for final connection.
  - No more than 2 sign posts shall be placed within a 7 ft. circle, except for specific materials noted on the CWZTCD List.
  - When project is completed, all sign supports and foundations shall be removed from the project site. This will be considered subsidiary to Item 502.
- \* See BC(4) for definition of "Work Duration."
  - \*\* Wood sign posts MUST be one piece. Splicing will NOT be allowed. Posts shall be painted white.
  - See the CWZTCD for the type of sign substrate that can be used for each approved sign support.

SHEET 5 OF 12



**BARRICADE AND CONSTRUCTION TYPICAL SIGN SUPPORT**

BC(5)-21

FILE:	bc-21.dgn	DATE:	09/11/02	BY:	ck
CONT:	REVISIONS	NO.	DATE	BY	
	001	6/4/02	17		
	002	8-14	7-13		
	003	5-21			
JOB:	US0075	COUNTY:	COLLIN	SHEET NO.:	13

**SKID MOUNTED PERFORATED SQUARE STEEL TUBING SIGN SUPPORTS**

\* LONG/INTERMEDIATE TERM STATIONARY - PORTABLE SKID MOUNTED SIGN SUPPORTS

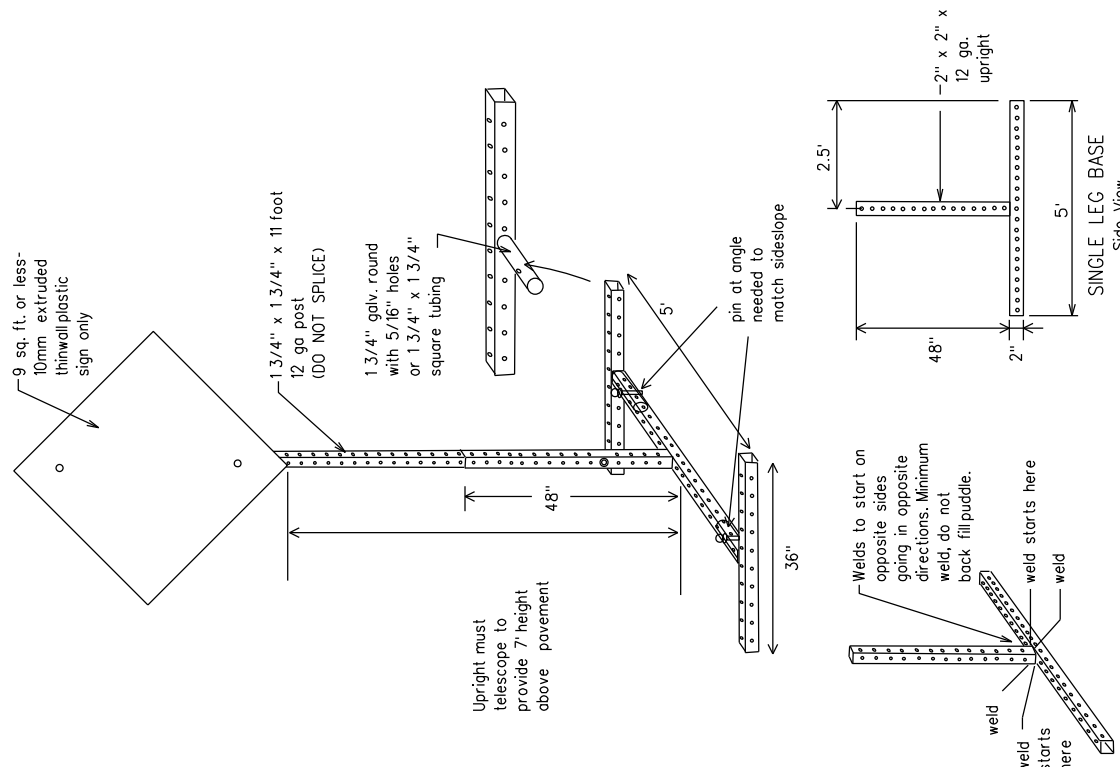



WHEN NOT IN USE, REMOVE THE PCMS FROM THE RIGHT-OF-WAY OR PLACE THE PCMS BEHIND BARRIER OR GUARDRAIL WITH SIGN PANEL TURNED PARALLEL TO TRAFFIC

PORTABLE CHANGEABLE MESSAGE SIGNS

- The Engineer/Inspector shall approve all messages used on portable changeable message signs (PCMS).
- Messages on PCMS should contain no more than 8 words (about four to eight characters per word), not including simple words such as "TO," "FOR," "AT," etc.
- Messages should consist of a single phase, or two phases that alternate. Three-phase messages are not allowed. Each phase of the message should convey a single thought, and must be understood by itself.
- Use the word "EXIT" to refer to an exit ramp on a freeway; i.e., "EXIT CLOSED." Do not use the term "RAMP."
- Always use the route or interstate designation (IH, US, SH, FM) along with the number when referring to a roadway.
- When in use, the bottom of a stationary PCMS message panel should be a minimum 7 feet above the roadway, where possible.
- The message term "WEEKEND" should be used only if the work is to start on Saturday morning and end by Sunday evening at midnight. Actual days and hours of work should be displayed on the PCMS if work is to begin on Friday evening and/or continue into Monday morning.
- The Engineer/Inspector may select one of two options which are available for displaying a two-phase message on a PCMS. Each phase may be displayed for either four seconds each or for three seconds each.
- Do not "flash" messages or words included in a message. The message should be steady burn or continuous while displayed.
- Do not present redundant information on a two-phase message; i.e., keeping two lines of the message the same and changing the third line.
- Do not use the word "Danger" in a message.
- Do not display the message "LANES SHIFT LEFT" or "LANES SHIFT RIGHT" on a PCMS. Drivers do not understand the message.
- Do not display messages that scroll horizontally or vertically across the face of the sign.
- The following table lists abbreviated words and two-word phrases that are acceptable for use on a PCMS. Both words in a phrase must be displayed together. Words or phrases not on this list should not be abbreviated, unless shown in the TMUTCD.
- PCMS character height should be at least 18 inches for trailer mounted units. They should be visible from at least 1/2 (.5) mile and the text should be legible from at least 600 feet at night and 800 feet in daylight. Truck mounted units must have a character height of 10 inches and must be legible from at least 400 feet.
- Each line of text should be centered on the message board rather than left or right justified.
- If disabled, the PCMS should default to an illegible display that will not alarm motorists and will only be used to alert workers that the PCMS has malfunctioned. A pattern such as a series of horizontal solid bars is appropriate.

WORD OR PHRASE	ABBREVIATION	WORD OR PHRASE	ABBREVIATION
Access Road	ACCS RD	Major	MAJ
Alternate	ALT	Miles	MI
Avenue	AVE	Miles Per Hour	MPH
Best Route	BEST RTE	Minor	MNR
Boulevard	BLVD	Monday	MON
Bridge	BRDG	Normal	NORM
Cannot	CANT	North	N
Center	CTR	Northbound	(route) N
Construction Ahead	CONST AHD	Parking	PKING
CROSSING	XING	Road	RD
Detour Route	DETOUR RTE	Right Lane	RT LN
Do Not	DONT	Saturday	SAT
East	E	Service Road	SERV RD
Eastbound	(route) E	Shoulder	SHLDR
Emergency	EMER	Slippery	SLIP
Emergency Vehicle	EMER VEH	South	S
Entrance, Enter	ENT	Southbound	(route) S
Express Lane	EXP LN	Speed	SPD
Expressway	EXPWY	Street	ST
XXXX Feet	XXXX FT	Sunday	SUN
Fog Ahead	FOG AHD	Telephone	PHONE
Freeway	FRWY, Fwy	Temporary	TEMP
Freeway Blocked	FRWY BLKD	Thursday	THURS
Friday	FRI	To Downtown	TO DWTN
Hazardous Driving	HAZ DRIVING	Traffic	TRAF
Hazardous Material	HAZMAT	Travelers	TRVLRS
High-Occupancy	HOV	Tuesday	TUES
Vehicle	HWY	Time Minutes	TIME MIN
Highway	HR, HRS	Upper Level	UPR LEVEL
Hours(s)	INFO	Vehicles (s)	VEH, VEHs
Information	ITS	Warning	WARN
It Is	JCT	Wednesday	WED
Junction	LFT	Weight Limit	WT LIMIT
Left	LFT	West	W
Left Lane	LFT LN	Westbound	(route) W
Lane Closed	LN CLOSED	West Pavement	WET PVMT
Lower Level	LWR LEVEL	Will Not	WONT
Maintenance	MAINT		

Roadway designation • IH-number, US-number, SH-number, FM-number

RECOMMENDED PHASES AND FORMATS FOR PCMS MESSAGES DURING ROADWORK ACTIVITIES  
(The Engineer may approve other messages not specifically covered here.)

Phase 1: Condition Lists

Road/Lane/Ramp Closure List	Other Condition List	Action to Take/Effect on Travel List	Location List	Warning List	Advance Notice List
FREEWAY CLOSED X MILE	ROADWORK XXX FT	MERGE RIGHT	AT FM XXXX	SPEED LIMIT XX MPH	TUE-FRI XX AM-XX PM
ROAD CLOSED AT SH XXX	FLAGGER XXXX FT	DETOUR NEXT X EXITS	BEFORE RAILROAD CROSSING	MAXIMUM SPEED XX MPH	APR XX-XX PM-X AM
ROAD CLSD AT FM XXXX	RIGHT LN NARROWS XXXX FT	USE EXIT XXX	NEXT X MILES	MINIMUM SPEED XX MPH	BEGINS MONDAY
RIGHT X LANES CLOSED	MERGING TRAFFIC XXXX FT	STAY ON US XXX SOUTH	PAST US XXX EXIT	ADVISORY SPEED XX MPH	BEGINS MAY XX
CENTER LANE CLOSED	LOOSE GRAVEL XXXX FT	TRUCKS USE US XXX N	XXXXXXX TO XXXXXX	RIGHT LANE EXIT	MAY X-X XX PM - XX AM
NIGHT LANE CLOSURES	DETOUR X MILE	WATCH FOR TRUCKS	US XXX TO FM XXXX	USE CAUTION	NEXT FRI-SUN
VARIOUS LANES CLOSED	ROADWORK PAST SH XXXX	EXPECT DELAYS	US XXX TO FM XXXX	DRIVE SAFELY	XX AM TO XX PM
EXIT CLOSED	BUMP XXXX FT	REDUCE SPEED XXX FT	US XXX TO FM XXXX	DRIVE WITH CARE	NEXT TUE AUG XX
MALL DRIVEWAY CLOSED	TRAFFIC SIGNAL XXXX FT	USE OTHER ROUTES	LANES SHIFT	WATCH FOR WORKERS	TONIGHT XX PM-XX AM
XXXXXXXXX BLVD CLOSED		STAY IN LANE			

LANES SHIFT in Phase 1 must be used with STAY IN LANE in Phase 2.

See Application Guidelines Note 6.

Phase 2: Possible Component Lists

Action to Take/Effect on Travel List	Location List	Warning List	Advance Notice List
MERGE RIGHT	AT FM XXXX	SPEED LIMIT XX MPH	TUE-FRI XX AM-XX PM
DETOUR NEXT X EXITS	BEFORE RAILROAD CROSSING	MAXIMUM SPEED XX MPH	APR XX-XX PM-X AM
USE EXIT XXX	NEXT X MILES	MINIMUM SPEED XX MPH	BEGINS MONDAY
STAY ON US XXX SOUTH	PAST US XXX EXIT	ADVISORY SPEED XX MPH	BEGINS MAY XX
TRUCKS USE US XXX N	XXXXXXX TO XXXXXX	RIGHT LANE EXIT	MAY X-X XX PM - XX AM
WATCH FOR TRUCKS	US XXX TO FM XXXX	USE CAUTION	NEXT FRI-SUN
EXPECT DELAYS	US XXX TO FM XXXX	DRIVE SAFELY	XX AM TO XX PM
REDUCE SPEED XXX FT	US XXX TO FM XXXX	DRIVE WITH CARE	NEXT TUE AUG XX
USE OTHER ROUTES	LANES SHIFT	WATCH FOR WORKERS	TONIGHT XX PM-XX AM
STAY IN LANE			

WORDING ALTERNATIVES

- The words RIGHT, LEFT and ALL can be interchanged as appropriate.
- Roadway designations IH, US, SH, FM and LP can be interchanged as appropriate.
- EAST, WEST, NORTH and SOUTH (or abbreviations E, W, N and S) can be interchanged as appropriate.
- Highway names and numbers replaced as appropriate.
- ROAD, HIGHWAY and FREEWAY can be interchanged as needed.
- AHEAD may be used instead of distances if necessary.
- FT and MI, MILE and MILES interchanged as appropriate.
- AT, BEFORE and PAST interchanged as needed.
- Distances or AHEAD can be eliminated from the message if a location phrase is used.

APPLICATION GUIDELINES

- Only 1 or 2 phases are to be used on a PCMS.
- The 1st phase (or both) should be selected from the "Road/Lane/Ramp Closure List" and the "Other Condition List".
- A 2nd phase can be selected from the "Action to Take/Effect on Travel, Location, General Warning, or Advance Notice Phase Lists".
- A Location Phrase is necessary only if a distance or location is not included in the first phase selected.
- If two PCMS are used in sequence, they must be separated by a minimum of 1000 ft. Each PCMS shall be limited to two phases, and should be understandable by themselves.
- For advance notice, when the current date is within seven days of the actual work date, calendar days should be replaced with days of the week. Advance notification should typically be for no more than one week prior to the work.

Texas Department of Transportation

Traffic Safety Division Standard

BARRICADE AND CONSTRUCTION PORTABLE CHANGEABLE MESSAGE SIGN (PCMS)

BC(6)-21

FILE: bc-21.dgn    DWG: TxDOT    CK: TxDOT    DW: TxDOT    CK: TxDOT

© TxDOT November 2002    CONT: SECT    JOB: 001    HIGHWAY: US0075

9-07    8-14    6465 17    001    COUNTY:    SHEET NO. 14

7-13    5-21    DAL    COLLIN

FULL MATRIX PCMS SIGNS

- When FullMatrix PCMS signs are used, the character height and legibility/visibility requirements shall be maintained as listed in Note 15 under "PORTABLE CHANGEABLE MESSAGE SIGNS" above.
- When symbol signs, such as the "Flagger Symbol" (CW20-7) are represented graphically on the FullMatrix PCMS sign and, with the approval of the Engineer, it shall maintain the legibility/visibility requirement listed above.
- When symbol signs are represented graphically on the FullMatrix PCMS, they shall only supplement the use of the static sign represented, and shall not substitute for, or replace that sign.
- A fullmatrix PCMS may be used to simulate a flashing arrow board provided it meets the visibility, flash rate and dimming requirements on BC(7), for the same size arrow.

PCMS SIGNS WITHIN THE R.O.W. SHALL BE BEHIND GUARDRAIL OR CONCRETE BARRIER OR SHALL HAVE A MINIMUM OF FOUR (4) PLASTIC DRUMS PLACED PERPENDICULAR TO TRAFFIC ON THE UPSTREAM SIDE OF THE PCMS, WHEN EXPOSED TO ONE DIRECTION OF TRAFFIC. WHEN EXPOSED TO TWO WAY TRAFFIC, THE FOUR DRUMS SHOULD BE PLACED WITH ONE DRUM AT EACH OF THE FOUR CORNERS OF THE UNIT.

DISCLAIMER: The use of this standard is governed by the "Texas Engineering Practice Act". No warranty of any kind is made by TxDOT for any purpose whatsoever. TxDOT assumes no responsibility for the conversion of this standard to other formats or for incorrect results or damages resulting from its use.



- Barrier Reflectors shall be pre-qualified, and conform to the color and reflectivity requirements of DMS-8600. A list of prequalified Barrier Reflectors can be found at the Material/Producer List web address shown on BC(1).
- Color of Barrier Reflectors shall be as specified in the T MUTCD. The cost of the reflectors shall be considered subsidiary to Item 512.

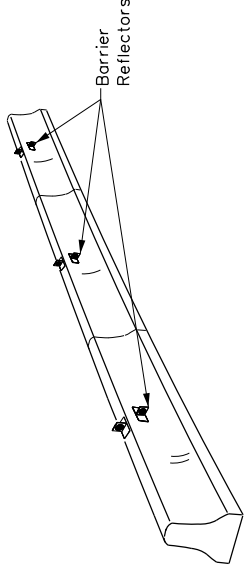

**CONCRETE TRAFFIC BARRIER (CTB)**

- Where traffic is on one side of the CTB, two (2) Barrier Reflectors shall be mounted in approximately the midsection of each section of CTB. An alternate mounting location is uniformly spaced at one end of each CTB. This will allow for attachment of a barrier grapple without damaging the reflector. The Barrier Reflector mounted on the side of the CTB shall be located directly below the reflector mounted on top of the barrier, as shown in the detail above.
- Where CTB separates two-way traffic, three barrier reflectors shall be mounted on each section of CTB. The reflector unit on top shall have two yellow reflective faces (B-Directional) while the reflectors on each side of the barrier shall have one yellow reflective face, as shown in the detail above.
- When CTB separates traffic traveling in the same direction, no barrier reflectors will be required on top of the CTB.
- Barrier Reflector units shall be yellow or white in color to match the edge line being supplemented.
- Maximum spacing of Barrier Reflectors is forty (40) feet.
- Pavement markers or temporary flexible-reflective roadway marker tabs shall NOT be used as CTB delineation.
- Attachment of Barrier Reflectors to CTB shall be per manufacturer's recommendations.
- Missing or damaged Barrier Reflectors shall be replaced as directed by the Engineer.
- Single slope barriers shall be delineated as shown on the above detail.

**LOW PROFILE CONCRETE BARRIER (LPCB) USED IN WORK ZONES**

LPCB is approved for use in work zone locations, where the posted speed is 45mph, or less. See Roadway Standard Sheet LPCB.

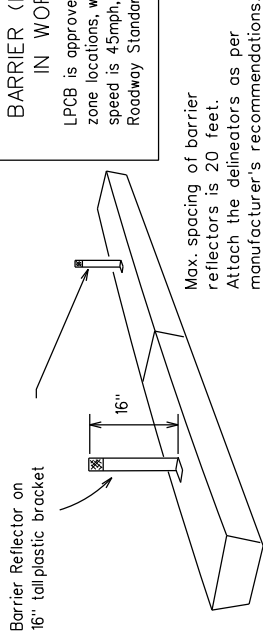

**LOW PROFILE CONCRETE BARRIER (LPCB)**

See D & OM (VIA)

Install a minimum of 3 Barrier Reflectors as per manufacturer's recommendations.

**DELINEATION OF END TREATMENTS**

**END TREATMENTS FOR CTB'S USED IN WORK ZONES**

End treatments used on CTBs in work zones shall meet the appropriate crashworthy standards as defined in the Manual for Assessing Safety Hardware (MASH). Refer to the CWZTCD List for approved end treatments and manufacturers.

**BARRIER REFLECTORS FOR CONCRETE TRAFFIC BARRIER AND ATTENUATORS**

**WARNING LIGHTS**

- Warning lights shall meet the requirements of the T MUTCD.
- Warning lights shall NOT be installed on barricades.
- Type A-Low Intensity Flashing Warning Lights are commonly used with drums. They are intended to warn of or mark a potentially hazardous area. Their use shall be as indicated on this sheet and/or other sheets of the plans by the designation "FL". The Type A Warning Lights shall not be used with signs manufactured with Type B or C sheeting, meeting the requirements of Departmental Material Specification DMS-8300.
- Type-C and Type D 360 degree Steady Burn Lights are intended to be used in a series for delineation to supplement other traffic control devices. Their use shall be as indicated on this sheet and/or other sheets of the plans by the designation "SB".
- The Engineer/Inspector or the plans shall specify the location and type of warning lights to be installed on the traffic control devices.
- When required by the Engineer, the Contractor shall furnish a copy of the warning lights certification. The warning light manufacturer will certify the warning lights meet the requirements of the latest ITE Purchase Specifications for Flashing and Steady-Burn Warning Lights.
- When used to delineate curves, Type-C and Type D Steady Burn Lights should only be placed on the outside of the curve, not the inside.
- The location of warning lights and warning reflectors on drums shall be as shown elsewhere in the plans.

**WARNING LIGHTS MOUNTED ON PLASTIC DRUMS**

- Type A flashing warning lights are intended to warn drivers that they are approaching or are in a potentially hazardous area.
- Type A random flashing warning lights are not intended for delineation and shall not be used in a series.
- A series of sequential flashing warning lights placed on channelizing devices to form a merging taper may be used for delineation. If used, the successive flashing of the sequential warning lights should occur from the beginning of the taper to the end of the merging taper in order to identify the desired vehicle path. The rate of flashing for each light shall be 65 flashes per minute, plus or minus 10 flashes.
- Type C and D steady-burn warning lights are intended to be used in a series to delineate the edge of the travel lane on detours, on lane changes, on lane closures, and on other similar conditions.
- Type A, Type C and Type D warning lights shall be installed at locations as detailed on other sheets in the plans.
- Warning lights shall not be installed on a drum that has a sign, chevron or vertical panel.
- The maximum spacing for warning lights on drums should be identical to the channelizing device spacing.

**WARNING REFLECTORS MOUNTED ON PLASTIC DRUMS AS A SUBSTITUTE FOR TYPE C (STEADY BURN) WARNING LIGHTS**

- A warning reflector or approved substitute may be mounted on a plastic drum as a substitute for a Type C, steady burn warning light at the discretion of the Contractor unless otherwise noted in the plans.
- The warning reflector shall be yellow in color and shall be manufactured using a sign substrate approved for use with plastic drums listed on the CWZTCD.
- The warning reflector shall have a minimum retroreflective surface area (one-side) of 30 square inches.
- Round reflectors shall be fully reflectorized, including the area where attached to the drum.
- Square substrates must have a minimum of 30 square inches of reflectorized sheeting. They do not have to be reflectorized where it attaches to the drum.
- The side of the warning reflector facing approaching traffic shall have sheeting meeting the color and retroreflectivity requirements for DMS 8300-Type B or Type C.
- When used near two-way traffic, both sides of the warning reflector shall be reflectorized.
- The warning reflector should be mounted on the side of the handle nearest approaching traffic.
- The maximum spacing for warning reflectors should be identical to the channelizing device spacing requirements.

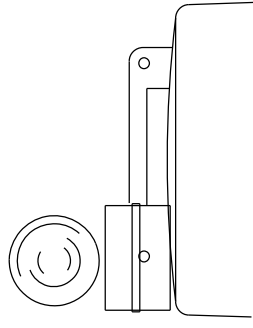

Type C Warning Light or approved substitute mounted on a drum adjacent to the travelway.

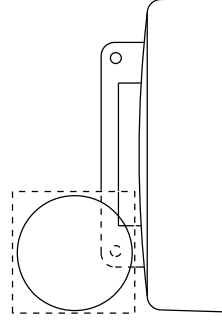

Warning reflector may be round or square. Must have a yellow reflective surface area of at least 30 square inches

Arrow Boards may be located behind channelizing devices in place for a shoulder taper or merging taper, otherwise they shall be delineated with four (4) channelizing devices placed perpendicular to traffic on the upstream side of traffic.

- The Flashing Arrow Board should be used for all lane closures on multi-lane roadways, or slow moving maintenance or construction activities on the travel lanes.
- Flashing Arrow Boards should not be used on two-lane, two-way roadways, detours, diversions or work on shoulders unless the "CAUTION" display (see detail below) is used.
- The Engineer/Inspector shall choose all appropriate signs, barricades and/or other traffic control devices that should be used in conjunction with the Flashing Arrow Board.
- The Flashing Arrow Board should be able to display the following symbols:

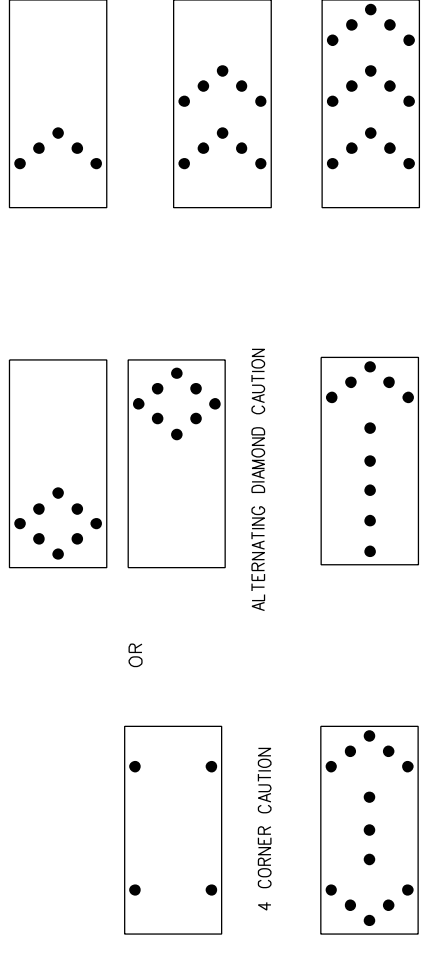

RIGHT/LEFT SEQUENTIAL CHEVRON (right chevron shown; left is similar)

RIGHT/LEFT ARROW (right arrow shown; left is similar)

ALTERNATING DIAMOND CAUTION

DOUBLE ARROW

4 CORNER CAUTION

5. The "CAUTION" display consists of four corner lamps flashing simultaneously, or the Alternating Diamond Caution mode as shown.

6. The straight line caution display is NOT ALLOWED.

7. The Flashing Arrow Board shall be capable of minimum 50 percent dimming from rated lamp voltage. The flashing rate of the lamps shall not be less than 25 nor more than 40 flashes per minute.

8. Minimum lamp "on time" shall be approximately 50 percent for the flashing arrow and equal intervals of 25 percent for each sequential phase of the flashing chevron.

9. The sequential arrow display is NOT ALLOWED.

10. The flashing arrow display is the TxDOT standard; however, the sequential chevron display may be used during daylight operations.

11. The Flashing Arrow Board shall be mounted on a vehicle, trailer or other suitable support.

12. A Flashing Arrow Board SHALL NOT BE USED to laterally shift traffic.

13. A full matrix PCMS may be used to simulate a Flashing Arrow Board provided it meets visibility, flash rate and dimming requirements on this sheet for the same size arrow.

14. Minimum mounting height of trailer mounted Arrow Boards should be 7 feet from roadway to bottom of panel.

TYPE	MINIMUM SIZE	MINIMUM NUMBER OF PANEL LAMPS	MINIMUM VISIBILITY DISTANCE
B	30 x 60	13	3/4 mile
C	48 x 96	15	1 mile

ATTENTION  
Flashing Arrow Boards shall be equipped with automatic dimming devices.

WHEN NOT IN USE, REMOVE THE ARROW BOARD FROM THE RIGHT-OF-WAY OR PLACE THE ARROW BOARD BEHIND CONCRETE TRAFFIC BARRIER OR GUARDRAIL.

**FLASHING ARROW BOARDS**

SHEET 7 OF 12

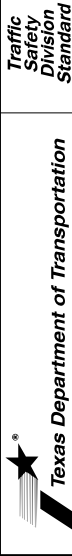

**BARRICADE AND CONSTRUCTION ARROW PANEL, REFLECTORS, WARNING LIGHTS & ATTENUATOR**

BC(7)-21

FILE:	bc-21.dgn	DATE:	November 2002	DATE:	October 2002	DATE:	October 2002	DATE:	October 2002
CONT:	SECTION	JOB:	001	DIST:	001	COUNTY:	COLLIN	DAL:	COLLIN
REVISIONS:	6465	17	001	US0075	9-07	8-14	7-13	5-21	15

**TRUCK-MOUNTED ATTENUATORS**

- Truck-mounted attenuators (TMA) used on TxDOT facilities must meet the requirements outlined in the Manual for Assessing Safety Hardware (MASH).
- Refer to the CWZTCD for the requirements of Level 2 or Level 3 TMAs.
- Refer to the CWZTCD for a list of approved TMAs.
- TMAs are required on freeways unless otherwise noted in the plans.
- A TMA should be used anytime that it can be positioned 30 to 100 feet in advance of the area of crew exposure without adversely affecting the work performance.
- The only reason a TMA should not be required is when a work area is spread down the roadway and the work crew is an extended distance from the TMA.

GENERAL NOTES

- For long term stationary work zones on freeways, drums shall be used as the primary channelizing device.
- For intermediate term stationary work zones on freeways, drums should be used as the primary channelizing device but may be replaced in tangent sections by vertical panels, or 42" two-piece cones. In tangent sections, one-piece cones may be used with the approval of the Engineer but only if personnel are present on the project at all times to maintain the cones in proper position and location.
- For short term stationary work zones on freeways, drums are the preferred channelizing device but may be replaced in tapers, transitions and tangent sections by vertical panels, two-piece cones or one-piece cones as approved by the Engineer.
- Drums and all related items shall comply with the requirements of the current version of the "Texas Manual on Uniform Traffic Control Devices" (TMUTCD) and the "Compliant Work Zone Traffic Control Devices List" (CWZTCD).
- Drums, bases, and related materials shall exhibit good workmanship and shall be free from objectionable marks or defects that would adversely affect their appearance or serviceability.
- The Contractor shall have a maximum of 24 hours to replace any plastic drums identified for replacement by the Engineer/Inspector. The replacement device must be an approved device.

GENERAL DESIGN REQUIREMENTS

Pre-qualified plastic drums shall meet the following requirements:

- Plastic drums shall be a two-piece design; the "body" of the drum shall be the top portion and the "base" shall be the bottom.
- The body and base shall lock together in such a manner that the body separates from the base when impacted by a vehicle traveling at a speed of 20 MPH or greater but prevents accidental separation due to normal handling and/or air turbulence created by passing vehicles.
- Plastic drums shall be constructed of lightweight flexible, and deformable materials. The Contractor shall NOT use metal drums or single piece plastic drums as channelizing devices or sign supports.
- Drums shall present a profile that is a minimum of 18 inches in width at the 36 inch height when viewed from any direction. The height of drum, unit (body installed on base) shall be a minimum of 36 inches and a maximum of 42 inches.
- The top of the drum shall have a built-in handle for easy pickup and shall be designed to drain water and not collect debris. The handle shall have a minimum of two widely spaced 9/16 inch diameter holes to allow attachment of a warning light, warning reflector unit or approved compliant sign.
- The exterior of the drum body shall have a minimum of four alternating orange and white retroreflective circumferential stripes not less than 4 inches nor greater than 8 inches in width. Any non-reflectORIZED space between any two adjacent stripes shall not exceed 2 inches in width.
- Bases shall have a maximum width of 36 inches, a maximum height of 4 inches, and a minimum of two footholds of sufficient size to allow base to be held down while separating the drum body from the base.
- Plastic drums shall be constructed of ultra-violet stabilized, orange, high-density polyethylene (HDPE) or other approved material.
- Drum body shall have a maximum unballasted weight of 11 lbs.
- Drum and base shall be marked with manufacturer's name and model number.

RETROREFLECTIVE SHEETING

- The stripes used on drums shall be constructed of sheeting meeting the color and retroreflectivity requirements of Departmental Materials Specification DMS-8300, "Sign Face Materials," Type A or Type B reflective sheeting shall be supplied unless otherwise specified in the plans.
- The sheeting shall be suitable for use on and shall adhere to the drum surface such that, upon vehicular impact, the sheeting shall remain adhered in-place and exhibit no delaminating, cracking, or loss of retroreflectivity other than that loss due to abrasion of the sheeting surface.

BALLAST

- Unballasted bases shall be large enough to hold up to 50 lbs. of sand. This base, when filled with the ballast material, should weigh between 35 lbs (minimum) and 50 lbs (maximum). The ballast may be sand in one to three sandbags separate from the base, sand in a sand-filled plastic base, or other ballasting devices as approved by the Engineer. Stacking of sandbags will be allowed, however height of sandbags above pavement surface may not exceed 12 inches.
- Bases with built-in ballast shall weigh between 40 lbs. and 50 lbs. Built-in ballast can be constructed of an integral crumb rubber base or a solid rubber base.
- Recycled truck tire sidewalls may be used for ballast on drums approved for this type of ballast on the CWZTCD list.
- The ballast shall not be heavy objects, water, or any material that would become hazardous to motorists, pedestrians, or workers when the drum is struck by a vehicle.
- When used in regions susceptible to freezing, drums shall have drainage holes in the bottoms so that water will not collect and freeze becoming a hazard when struck by a vehicle.
- Ballast shall not be placed on top of drums.
- Adhesives may be used to secure base of drums to pavement.

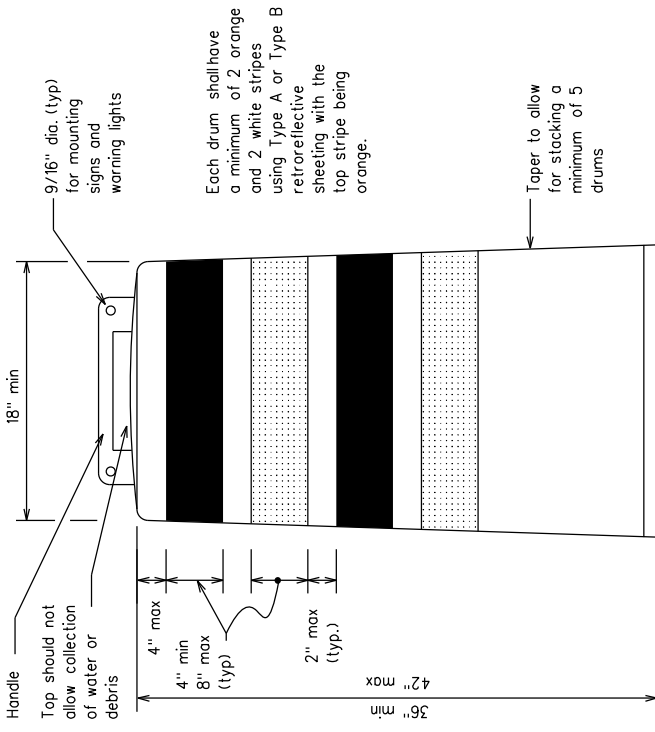

This detail is not intended for fabrication. See note 3 and the CWZTCD list for providers of approved Detectable Pedestrian Barricades

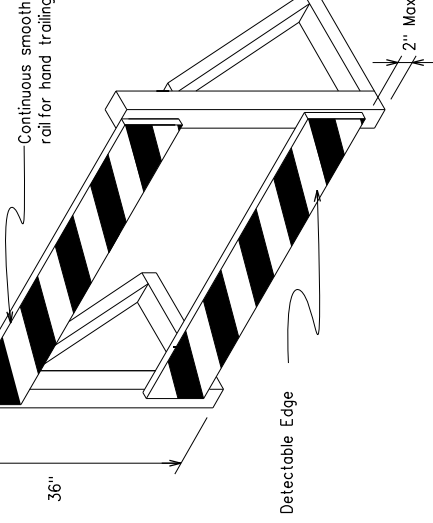

DETECTABLE PEDESTRIAN BARRICADES

- When existing pedestrian facilities are disrupted, closed, or relocated in a TTC zone, the temporary facilities shall be detectable and include accessibility features consistent with the features present in the existing pedestrian facility. Refer to WZ(BTS-2) for Pedestrian Control requirements for Sidewalk Diversions, Sidewalk Detours and Crosswalk Closures.
- Where pedestrians with visual disabilities normally use the closed sidewalk, a Detectable Pedestrian Barricade shall be placed across the full width of the closed sidewalk instead of a Type 3 Barricade.
- Detectable pedestrian barricades similar to the one pictured above, longitudinal channelizing devices, some concrete barriers, and wood or chain link fencing with a continuous detectable edging can satisfactorily delineate a pedestrian path.
- Tape, rope, or plastic chain strung between devices are not detectable, do not comply with the design standards in the "Americans with Disabilities Act Accessibility Guidelines (ADAAG)" and should not be used as a control for pedestrian movements.
- Warning lights shall not be attached to detectable pedestrian barricades.
- Detectable pedestrian barricades should use 8" nominal barricade rails as shown on BC(10) provided that the top rail provides a smooth continuous rail suitable for hand trailing with no splinters, burrs, or sharp edges.

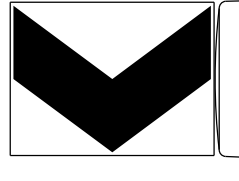

18" x 24" Sign  
(Maximum Sign Dimension)  
Chevron CW1-8, Opposing Traffic Lane Divider, Driveway sign D70a, Keep Right R4 series or other signs as approved by Engineer



12" x 24"  
Vertical Panel  
mount with diagonals sloping down towards travel way

Plywood, Aluminum or Metal sign substrates shall NOT be used on plastic drums

SIGNS, CHEVRONS, AND VERTICAL PANELS MOUNTED ON PLASTIC DRUMS

- Signs used on plastic drums shall be manufactured using substrates listed on the CWZTCD.
- Chevrons and other work zone signs with an orange background shall be manufactured with Type B or Type C Orange sheeting meeting the color and retroreflectivity requirements of DMS-8300, "Sign Face Material," unless otherwise specified in the plans.
- Vertical Panels shall be manufactured with orange and white sheeting meeting the requirements of DMS-8300 Type A or Type B. Diagonal stripes on Vertical Panels shall slope down toward the intended traveled lane.
- Other sign messages (text or symbolic) may be used as approved by the Engineer. Sign dimensions shall not exceed 18 inches in width or 24 inches in height, except for the R9 series signs discussed in note 8 below.
- Signs shall be installed using a 1/2 inch bolt (nominal) and nut, two washers, and one locking washer for each connection.
- Mounting bolts and nuts shall be fully engaged and adequately torqued. Bolts should not extend more than 1/2 inch beyond nuts.
- Chevrons may be placed on drums on the outside of curves, on merging tapers or on shifting tapers. When used in these locations, they may be placed on every drum or spaced not more than on every third drum. A minimum of three (3) should be used at each location called for in the plans.
- R9-9, R9-10, R9-11 and R9-11a Sidewalk Closed signs which are 24 inches wide may be mounted on plastic drums, with approval of the Engineer.



Texas Department of Transportation  
Traffic Safety Division Standard

BARRICADE AND CONSTRUCTION CHANNELIZING DEVICES

BC(8) - 21

FILE:	bc-21.dgn	DATE:	November 2002	PROJECT:	001	JOB:	US0075
DATE:	4-03 8-14	REVISIONS:	9-07 5-21	COUNT:	001	COUNT:	001
				DIST:		COUNTY:	
				DAL:		COLLIN:	16

DISCLAIMER: The use of this standard is governed by the "Texas Engineering Practice Act". No warranty of any kind is made by TxDOT for any purpose whatsoever. TxDOT assumes no responsibility for the conversion of this standard to other formats or for incorrect results or damages resulting from its use.

DISCLAIMER: The use of this standard is governed by the "Texas Engineering Practice Act". No warranty of any kind is made by TxDOT for any purpose whatsoever. TxDOT assumes no responsibility for the conversion of this standard to other formats or for incorrect results or damages resulting from its use.

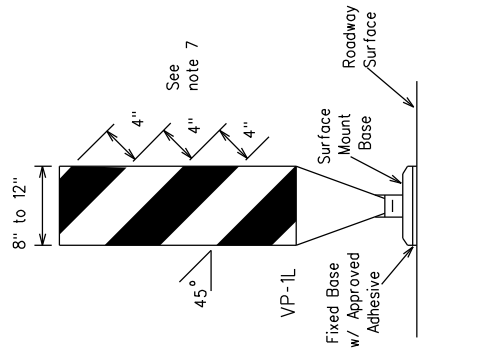

**FIXED**  
(Rigid or self-righting)

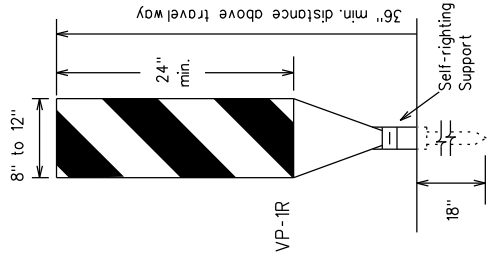

**DRIVEABLE**

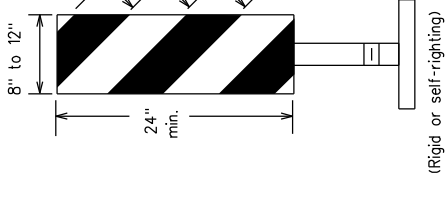

**PORTABLE**  
(Rigid or self-righting)

- Vertical Panels (VP's) are normally used to channelize traffic or divide opposing lanes of traffic.
- VP's may be used in daytime or nighttime situations. They may be used at the edge of shoulder drop-offs and other areas such as lane transitions where positive daytime and nighttime delineation is required. The Engineer/Inspector shall refer to the Roadway Design Manual for additional requirements on the use VP's for drop-offs.
- VP's should be mounted back to back if used at the edge of cuts adjacent to two-way lane roadways. Stripes are to be reflective orange and reflective white and should always slope downward toward the travel lane.
- VP's used on expressways and freeways or other high speed roadways, may have more than 270 square inches of retroreflective area facing traffic.
- Self-righting supports are available with portable bases. See "Compliant Work Zone Traffic Control Devices List" (CWZTCD).
- Sheeting for the VP's shall be retroreflective Type A or Type B conforming to Departmental Material Specification DMS-8300, unless noted otherwise.
- Where the height of reflective material on the vertical panels is 36 inches or greater, a panel stripe of 6 inches shall be used.

**VERTICAL PANELS (VPS)**

- Opposing Traffic Lane Dividers (OTLD) are delineation devices designed to convert a normal one-way roadway section to two-way operation. OTLD's are used on temporary centerlines. The upward and downward arrows on the sign's face indicate the direction of traffic on either side of the divider. The base is secured to the pavement with an adhesive or rubber weight to minimize movement caused by a vehicle impact or wind gust.
- The OTLD may be used in combination with 42" cones or VPs.
- Spacing between the OTLD shall not exceed 500 feet. 42" cones or VPs placed between the OTLD's should not exceed 100 foot spacing.
- The OTLD shall be orange with a black non-reflective legend. Sheeting for the OTLD shall be retroreflective Type B or Type C conforming to Departmental Material Specification DMS-8300, unless noted otherwise. The legend shall meet the requirements of DMS-8300.

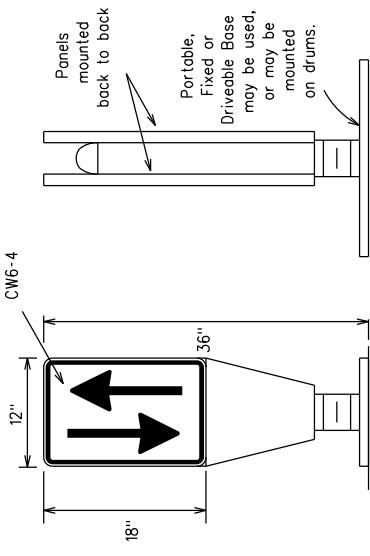

**OPPOSING TRAFFIC LANE DIVIDERS (OTLD)**

- The chevron shall be a vertical rectangle with a minimum size of 12 by 18 inches.
- Chevrons are intended to give notice of a sharp change of alignment with the direction of travel and provide additional emphasis and guidance for vehicle operators with regard to changes in horizontal alignment of the roadway.
- Chevrons, when used, shall be erected on the outside of a sharp curve or turn, or on the far side of an intersection. They shall be in line with and at right angles to approaching traffic. Spacing should be such that the motorist always has three in view, until the change in alignment eliminates its need.
- To be effective, the chevron should be visible for at least 500 feet.
- Chevrons shall be orange with a black nonreflective legend. Sheeting for the chevron shall be retroreflective Type B or Type C, conforming to Departmental Material Specification DMS-8300, unless noted otherwise. The legend shall meet the requirements of DMS-8300.
- For Long Term Stationary use on tapers or transitions on freeways and divided highways, self-righting chevrons may be used to supplement plastic drums but not to replace plastic drums.

**CHEVRONS**

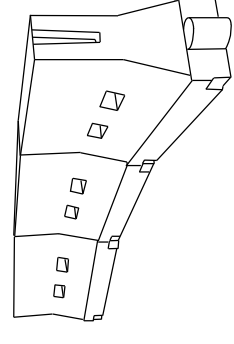

**LONGITUDINAL CHANNELIZING DEVICES (LCD)**

- LCDs are crashworthy, lightweight, deformable devices that are highly visible, have good target value and can be connected together. They are not designed to contain or redirect a vehicle on impact.
- LCDs may be used instead of a line of cones or drums.
- LCDs shall be placed in accordance to application and installation requirements specific to the device, and used only when shown on the CWZTCD list.
- LCDs should not be used to provide positive protection for obstacles, pedestrians or workers.
- LCDs shall be supplemented with retroreflective delineation as required for temporary barriers on BC(7) when placed roughly parallel to the travel lanes.
- LCDs used as barricades placed perpendicular to traffic should have at least one row of reflective sheeting meeting the requirements for barricade rolls as shown on BC(10). Place reflective sheeting near the top of the LCD along the full length of the device.

**WATER BALLASTED SYSTEMS USED AS BARRIERS**

- Water ballasted systems used as barriers shall not be used solely to channelize road users, but also to protect the work space per the appropriate Manual for Assessing Safety Hardware (MASH) crashworthiness requirements based on roadway speed and barrier application.
- Water ballasted systems used to channelize vehicular traffic shall be supplemented with retroreflective delineation or channelizing devices to improve daytime/nighttime visibility. They may also be supplemented with pavement markings.
- Water ballasted systems used as barriers shall be placed in accordance to application and installation requirements specific to the device, and used only when shown on the CWZTCD list.
- Water ballasted systems used as barriers should not be used for a merging taper except in low speed (less than 45 MPH) urban areas. When used on a taper in a low speed urban area, the taper shall be delineated and the taper length should be designed to optimize road user operations considering the available geometric conditions.
- When water ballasted systems used as barriers have blunt ends exposed to traffic, they should be attenuated as per manufacturer recommendations or flared to a point outside the clear zone.

If used to channelize pedestrians, longitudinal channelizing devices or water ballasted systems must have a continuous detectable bottom for users of long canes and the top of the unit shall not be less than 32 inches in height.

**HOLLOW OR WATER BALLASTED SYSTEMS USED AS LONGITUDINAL CHANNELIZING DEVICES OR BARRIERS**

**GENERAL NOTES**

- Work Zone channelizing devices illustrated on this sheet may be installed in close proximity to traffic and are suitable for use on high or low speed roadways. The Engineer/Inspector shall ensure that spacing and placement is uniform and in accordance with the "Texas Manual on Uniform Traffic Control Devices" (TMUTCD).
- Channelizing devices shown on this sheet may have a driveable, fixed or portable base. The requirement for self-righting channelizing devices must be specified in the General Notes or other plan sheets.
- Channelizing devices on self-righting supports should be used in work zone areas where channelizing devices are frequently impacted by errant vehicles or vehicle related wind gusts making alignment of the channelizing devices difficult to maintain. Locations of these devices shall be detailed elsewhere in the plans. These devices shall conform to the TMUTCD and the "Compliant Work Zone Traffic Control Devices List" (CWZTCD).
- The Contractor shall maintain devices in a clean condition and replace damaged, nonreflective, faded, or broken devices and bases as required by the Engineer/Inspector. The Contractor shall be required to maintain proper device spacing and alignment.
- Portable bases shall be fabricated from virgin and/or recycled rubber. The portable bases shall weigh a minimum of 30 lbs.
- Pavement surfaces shall be prepared in a manner that ensures proper bonding between the adhesives, the fixed mount bases and the pavement surface. Adhesives shall be prepared and applied according to the manufacturer's recommendations.
- The installation and removal of channelizing devices shall not cause detrimental effects to the final pavement surfaces, including pavement surface discoloration or surface integrity. Driveable bases shall not be permitted on final pavement surfaces. The Engineer/Inspector shall approve all application and removal procedures of fixed bases.

Posted Speed	Formula	Minimum Desirable Taper Lengths x x				Suggested Maximum Spacing of Channelizing Devices
		10' Orfset	11' Orfset	12' Orfset	On a Taper On a Tangent	
30		150'	165'	180'	30'	60'
35	$WS^2$	205'	225'	245'	35'	70'
40	$L = \frac{WS^2}{60}$	265'	295'	320'	40'	80'
45		450'	495'	540'	45'	90'
50		500'	550'	600'	50'	100'
55	$L = WS$	550'	605'	660'	55'	110'
60		600'	660'	720'	60'	120'
65		650'	715'	780'	65'	130'
70		700'	770'	840'	70'	140'
75		750'	825'	900'	75'	150'
80		800'	880'	960'	80'	160'

x x Taper lengths have been rounded off.  
L-Length of Taper (FT.) W-Width of Orfset (FT.)  
S-Posted Speed (MPH)

**SUGGESTED MAXIMUM SPACING OF CHANNELIZING DEVICES AND MINIMUM DESIRABLE TAPER LENGTHS**

SHEET 9 OF 12

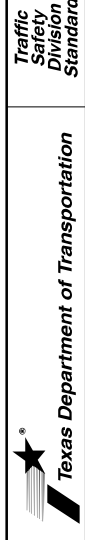

**BARRICADE AND CONSTRUCTION CHANNELIZING DEVICES**

BC(9) -21

FILE:	bc-21.dgn	DATE:	11/01/01	BY:	TJDOOT	CHK:	TJDOOT
CONT:	November 2002	REVISED:	001	JOB:	HIGHWAY		
			6465	17	001	US0075	
	9-07	8-14				COUNTY:	
	7-13	5-21				DAL	COLLIN
						SHEET NO.:	17

**TYPE 3 BARRICADES**

1. Refer to the Compliant Work Zone Traffic Control Devices List (CWZTCD) for details of the Type 3 Barricades and a list of all materials used in the construction of Type 3 Barricades.
2. Type 3 Barricades shall be used at each end of construction projects closed to all traffic.
3. Barricades extending across a roadway should have stripes that slope downward in the direction toward which traffic must turn in detouring. When both right and left turns are provided, the chevron striping may slope downward in both directions from the center of the barricade. Where no turns are provided at a closed road, striping should slope downward in both directions toward the center of roadway.
4. Striping of rails, for the right side of the roadway, should slope downward to the left. For the left side of the roadway, striping should slope downward to the right.
5. Identification markings may be shown only on the back of the barricade rails. The maximum height of letters and/or company logos used for identification shall be 1".
6. Barricades shall not be placed parallel to traffic unless an adequate clear zone is provided.
7. Warning lights shall NOT be installed on barricades.
8. Where barricades require the use of weights to keep from turning over, the use of sandbags with dry, cohesionless sand is recommended. The sandbags will be tied shut to keep the sand from spilling and to maintain a constant weight. Sand bags shall not be stacked in a manner that covers any portion of a barricade rail's reflective sheeting. Rock, concrete, iron, steel or other solid objects will NOT be permitted. Sandbags should weigh a minimum of 35 lbs and a maximum of 50 lbs. Sandbags shall be made of a durable material that tears upon vehicular impact. Rubber (such as tire inner tubes) shall not be used for sandbags. Sandbags shall only be placed along or upon the base supports of the device and shall not be suspended above ground level or hung with rope, wire, chains or other fasteners.
9. Sheeting for barricades shall be retroreflective Type A or Type B conforming to Departmental Material Specification DMS-8300 unless otherwise noted.

Barricades shall NOT be used as a sign support.

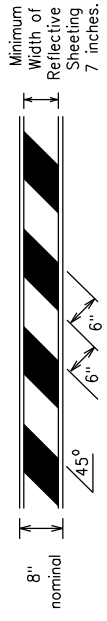

**TYPICAL STRIPING DETAIL FOR BARRICADE RAIL**

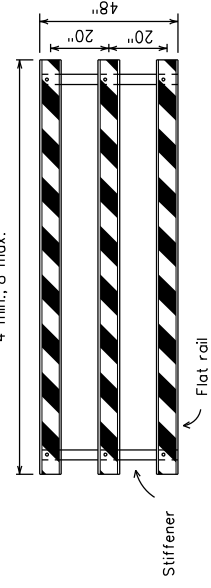

Stiffener may be inside or outside of support, but no more than 2 stiffeners shall be allowed on one barricade.

**TYPICAL PANEL DETAIL FOR SKID OR POST TYPE BARRICADES**

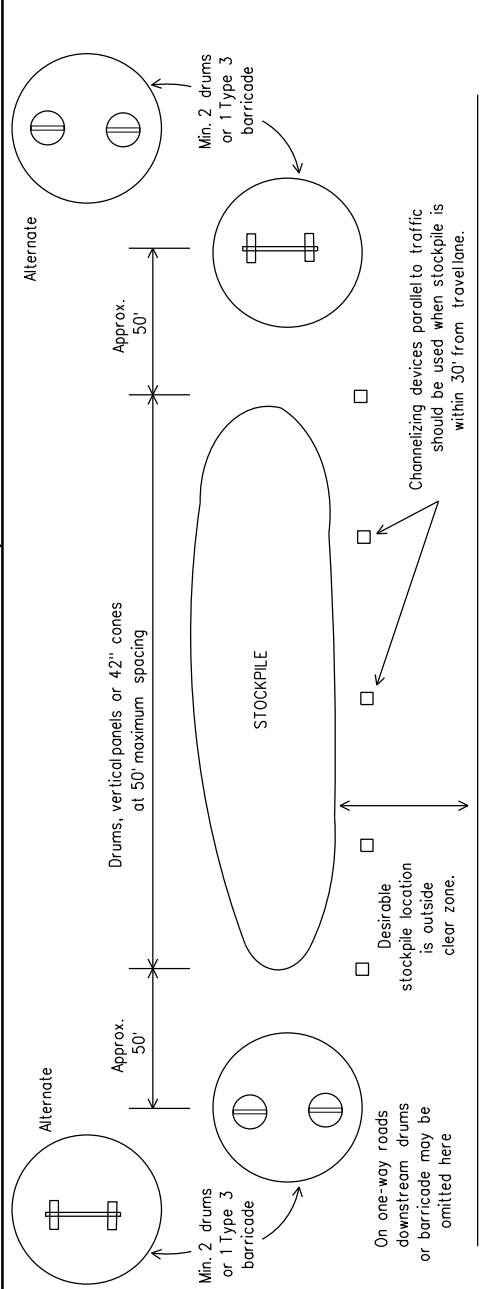

**TRAFFIC CONTROL FOR MATERIAL STOCKPILES**

Each roadway of a divided highway shall be barricaded in the same manner.

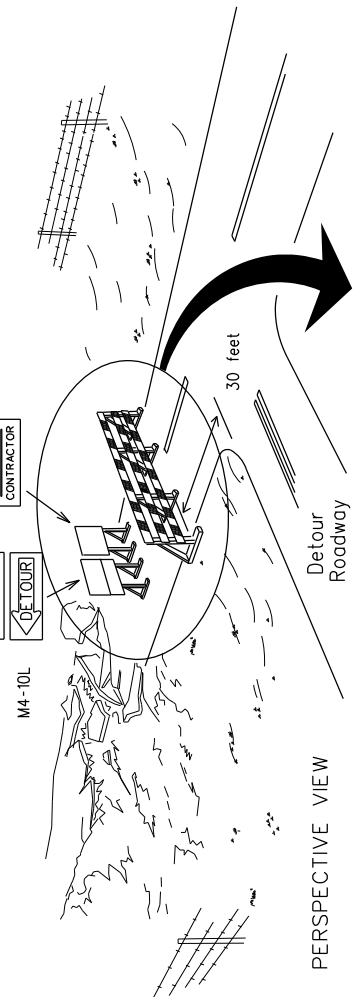

PERSPECTIVE VIEW

The three rolls on Type 3 barricades shall be reflectorized orange and reflective white stripes on one side facing one-way traffic and both sides for two-way traffic. Barricade striping should slant downward in the direction of detour.

1. Signs should be mounted on independent supports at a 7 foot mounting height in center of roadway. The signs should be a minimum of 10 feet behind Type 3 Barricades.
2. Advance signing shall be as specified elsewhere in the plans.

PLAN VIEW

**TYPE 3 BARRICADE (POST AND SKID) TYPICAL APPLICATION**

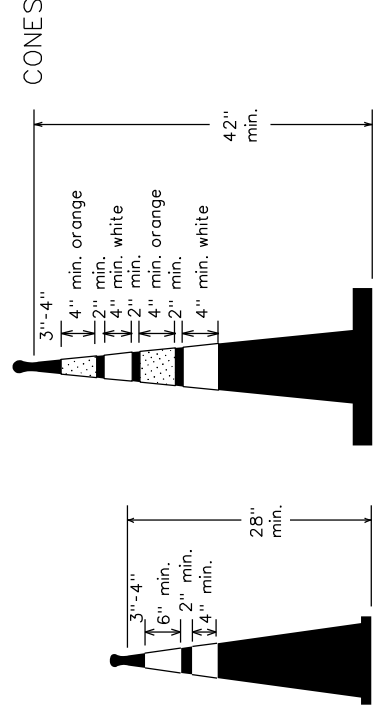

Two-Piece cones

One-Piece cones

28" Cones shall have a minimum weight of 9 1/2 lbs.  
42" 2-piece cones shall have a minimum weight of 30 lbs. including base.

1. Traffic cones and tubular markers shall be predominantly orange, and meet the height and weight requirements shown above.
2. One-piece cones have the body and base of the cone molded in one consolidated unit. Two-piece cones have a cone shaped body and a separate rubber base, or ballast, that is added to keep the device upright and in place.
3. Two-piece cones may have a handle or loop extending up to 8" above the minimum height shown, in order to aid in retrieving the device.
4. Cones or tubular markers shall have white or white and orange reflective bands as shown above. The reflective bands shall have a smooth, sealed outer surface and meet the requirements of Departmental Material Specification DMS-8300 Type A or Type B.
5. 28" cones and tubular markers are generally suitable for short duration and short-term stationary work as defined on BC(4). These should not be used for intermediate-term or long-term stationary work unless personnel on-site to maintain them in their proper upright position.
6. 42" two-piece cones, vertical panels or drums are suitable for all work zone durations.
7. Cones or tubular markers used on each project should be of the same size and shape.

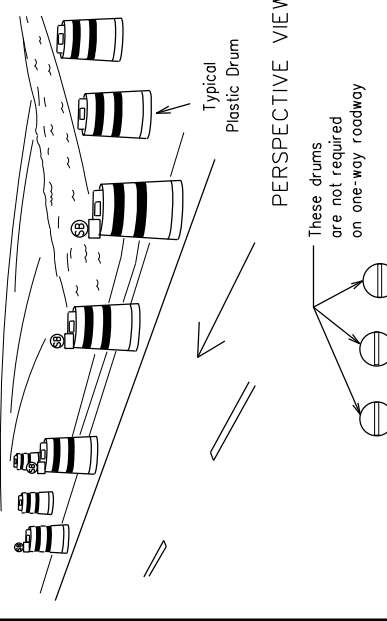

PERSPECTIVE VIEW

These drums are not required on one-way roadway

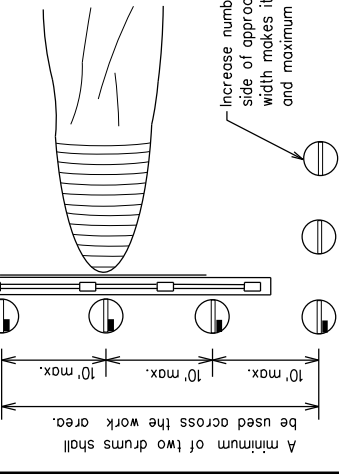

PLAN VIEW

**CULVERT WIDENING OR OTHER ISOLATED WORK WITHIN THE PROJECT LIMITS**

1. Where positive redirection capability is provided, drums may be omitted.
2. Plastic construction fencing may be substituted with drums for safety as required in the plans.
3. Vertical Panels on flexible support may be substituted for drums when the shoulder width is less than 4 feet.
4. When the shoulder width is greater than 12 feet, steady-burn lights may be omitted if drums are used.
5. Drums must extend the length of the culvert widening.

**LEGEND**

	Plastic drum
	Plastic drum with steady burn light or yellow warning reflector
	Steady burn warning light or yellow warning reflector

Texas Department of Transportation  
Traffic Safety Division Standard

**BARRICADE AND CONSTRUCTION CHANNELIZING DEVICES**

**BC(10)-21**

FILE:	bc-21.dgn	DATE:	November 2002	JOB:	US0075
CONT:	TxDOT	SECT:	001	DIST:	001
REVISIONS:	9-07	8-14	7-13	COUNTY:	COLLIN
DRAWN:	bc-21.dgn	CHECKED:	TxDOT	DATE:	05-21
SHEET NO.:	18				

**WORK ZONE PAVEMENT MARKINGS**

**GENERAL**

1. The Contractor shall be responsible for maintaining work zone and existing pavement markings, in accordance with the standard specifications and special provisions, on all roadways open to traffic within the CSJ limits unless otherwise stated in the plans.
2. Color, patterns and dimensions shall be in conformance with the "Texas Manual on Uniform Traffic Control Devices" (TMUTCD).
3. Additional supplemental pavement marking details may be found in the plans or specifications.
4. Pavement markings shall be installed in accordance with the TMUTCD and as shown on the plans.
5. When short term markings are required on the plans, short term markings shall conform with the TMUTCD, the plans and details as shown on the Standard Plan Sheet WZ(STPM).
6. When standard pavement markings are not in place and the roadway is opened to traffic, DO NOT PASS signs shall be erected to mark the beginning of the sections where passing is prohibited and PASS WITH CARE signs at the beginning of sections where passing is permitted.
7. All work zone pavement markings shall be installed in accordance with Item 662, "Work Zone Pavement Markings."

**RAISED PAVEMENT MARKERS**

1. Raised pavement markers are to be placed according to the patterns on BC(12).
2. All raised pavement markers used for work zone markings shall meet the requirements of Item 672, "RAISED PAVEMENT MARKERS" and Departmental Material Specification DMS-4200 or DMS-4300.

**PREFABRICATED PAVEMENT MARKINGS**

1. Removable prefabricated pavement markings shall meet the requirements of DMS-8241.
2. Non-removable prefabricated pavement markings (foilback) shall meet the requirements of DMS-8240.

**MAINTAINING WORK ZONE PAVEMENT MARKINGS**

1. The Contractor will be responsible for maintaining work zone pavement markings within the work limits.
2. Work zone pavement markings shall be inspected in accordance with the frequency and reporting requirements of work zone traffic control device inspections as required by Form 599.
3. The markings should provide a visible reference for a minimum distance of 300 feet during normal daylight hours and 160 feet when illuminated by automobile low-beam headlights at night, unless sight distance is restricted by roadway geometrics.
4. Markings failing to meet this criteria within the first 30 days after placement shall be replaced at the expense of the Contractor as per Specification Item 662.

**REMOVAL OF PAVEMENT MARKINGS**

1. Pavement markings that are no longer applicable, could create confusion or direct a motorist toward or into the closed portion of the roadway shall be removed or obliterated before the roadway is opened to traffic.
2. The above shall not apply to detours in place for less than three days, where loggers and/or sufficient channelizing devices are used in lieu of markings to outline the detour route.
3. Pavement markings shall be removed to the fullest extent possible, so as not to leave a discernable marking. This shall be by any method approved by TxDOT Specification Item 677 for "Eliminating Existing Pavement Markings and Markers".
4. The removal of pavement markings may require resurfacing or seal coating portions of the roadway as described in Item 677.
5. Subject to the approval of the Engineer, any method that proves to be successful on a particular type pavement may be used.
6. Blast cleaning may be used but will not be required unless specifically shown in the plans.
7. Over-painting of the markings SHALL NOT BE permitted.
8. Removal of raised pavement markers shall be as directed by the Engineer.
9. Removal of existing pavement markings and markers will be paid for directly in accordance with Item 677, "ELIMINATING EXISTING PAVEMENT MARKINGS AND MARKERS," unless otherwise stated in the plans.
10. Block-out marking tape may be used to cover conflicting existing markings for periods less than two weeks when approved by the Engineer.

**Temporary Flexible-Reflective Roadway Marker Tabs**

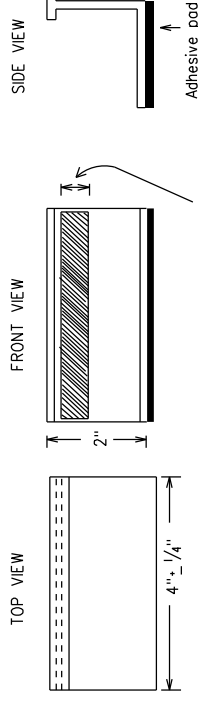

**STAPLES OR NAILS SHALL NOT BE USED TO SECURE TEMPORARY FLEXIBLE-REFLECTIVE ROADWAY MARKER TABS TO THE PAVEMENT SURFACE**

1. Temporary flexible-reflective roadway marker tabs used as guidemarks shall meet the requirements of DMS-8242.
2. Tabs detailed on this sheet are to be inspected and accepted by the Engineer or designated representative. Sampling and testing is not normally required, however at the option of the Engineer, either "A" or "B" below may be imposed to assure quality before placement on the roadway.
  - A. Select five (5) or more tabs at random from each lot or shipment and submit to the Construction Division, Materials and Pavement Section to determine specification compliance.
  - B. Select five (5) tabs and perform the following test. Affix five (5) tabs at 24 inch intervals on an asphaltic pavement in a straight line. Using a medium size passenger vehicle or pickup, run over the markers with the front and rear tires at a speed of 35 to 40 miles per hour, four (4) times in each direction. No more than one (1) out of the five (5) reflective surfaces shall be lost or displaced as a result of this test.
3. Small design variances may be noted between tab manufacturers.
4. See Standard Sheet WZ(STPM) for tab placement on new pavements. See Standard Sheet TCP(7-1) for tab placement on sealcoat work.

**RAISED PAVEMENT MARKERS USED AS GUIDEMARKS**

1. Raised pavement markers used as guidemarks shall be from the approved product list, and meet the requirements of DMS-4200.
2. All temporary construction raised pavement markers provided on a project shall be of the same manufacturer.
3. Adhesive for guidemarks shall be bituminous material hot applied or butyl rubber pad for all surfaces, or thermoplastic for concrete surfaces.

Guidemarks shall be designated as:  
 YELLOW - (two amber reflective surfaces with yellow body).  
 WHITE - (one silver reflective surface with white body).

DEPARTMENTAL PAVEMENT MARKERS (REFLECTORIZED)	MATERIAL SPECIFICATIONS
TRAFFIC BUTTONS	DMS-4200
EPOXY AND ADHESIVES	DMS-4300
BITUMINOUS ADHESIVE FOR PAVEMENT MARKERS	DMS-6100
PERMANENT PREFABRICATED PAVEMENT MARKINGS	DMS-6130
TEMPORARY REMOVABLE, PREFABRICATED PAVEMENT MARKINGS	DMS-8240
TEMPORARY FLEXIBLE, REFLECTIVE ROADWAY MARKER TABS	DMS-8241
	DMS-8242

A list of prequalified reflective raised pavement markers, non-reflective traffic buttons, roadway marker tabs and other pavement markings can be found at the Material/Producer List web address shown on BC(1).

SHEET 11 OF 12



Texas Department of Transportation

**BARRICADE AND CONSTRUCTION PAVEMENT MARKINGS**

BC(11) - 21

FILE: bc-21.dgn	DATE: February 1998	JOB: 001	PROJECT: US0075
CONT: 6465	SECT: 17	DIST: 001	COUNTY: COLLIN
2-98	9-07	5-21	
1-02	7-13		
11-02	8-14		
SHEET NO.			19

### PAVEMENT MARKING PATTERNS

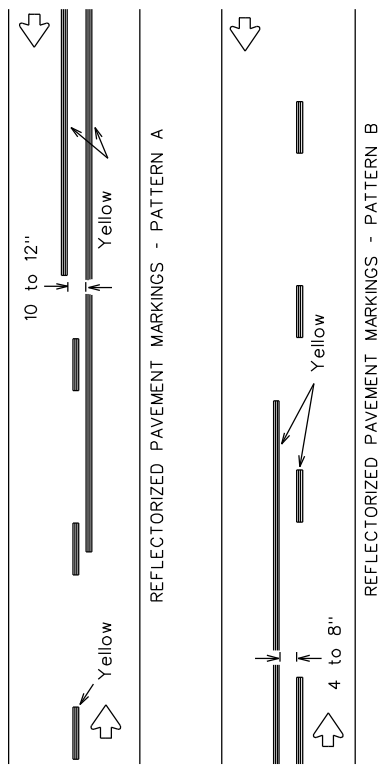

Pattern A is the TXDOT Standard, however, Pattern B may be used if approved by the Engineer. Prefabricated markings may be substituted for reflectorized pavement markings.

### CENTER LINE & NO-PASSING ZONE BARRIER LINES FOR TWO-LANE, TWO-WAY HIGHWAYS

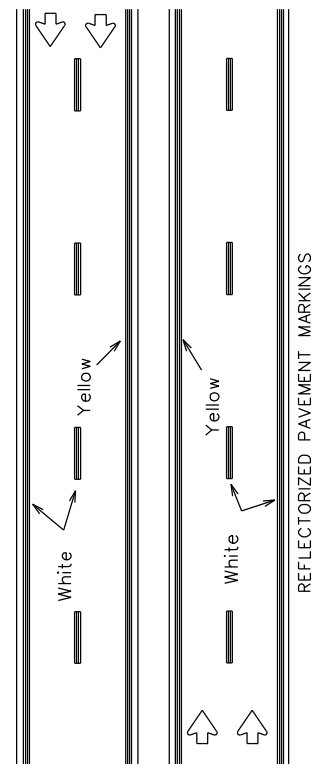

Prefabricated markings may be substituted for reflectorized pavement markings.

### EDGE & LANE LINES FOR DIVIDED HIGHWAY

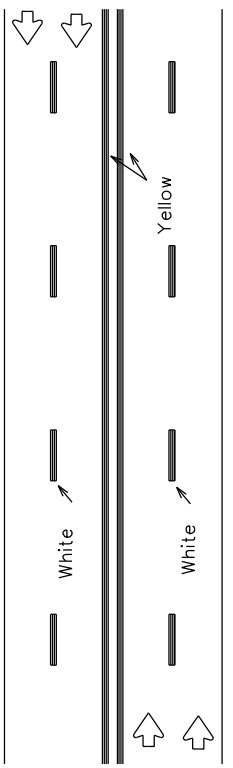

Prefabricated markings may be substituted for reflectorized pavement markings.

### LANE & CENTER LINES FOR MULTILANE UNDIVIDED HIGHWAYS

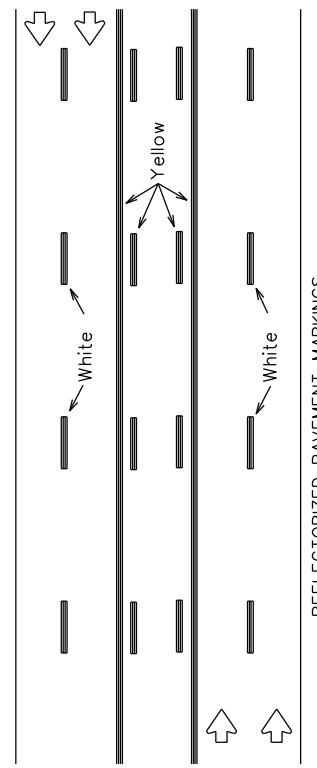

Prefabricated markings may be substituted for reflectorized pavement markings.

### TWO-WAY LEFT TURN LANE

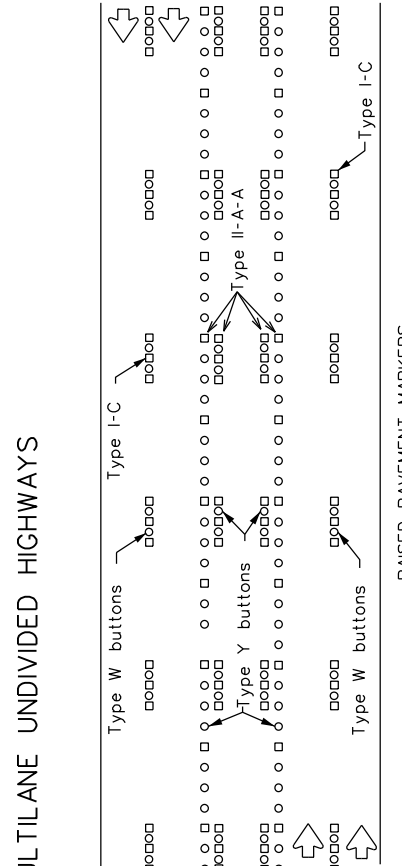
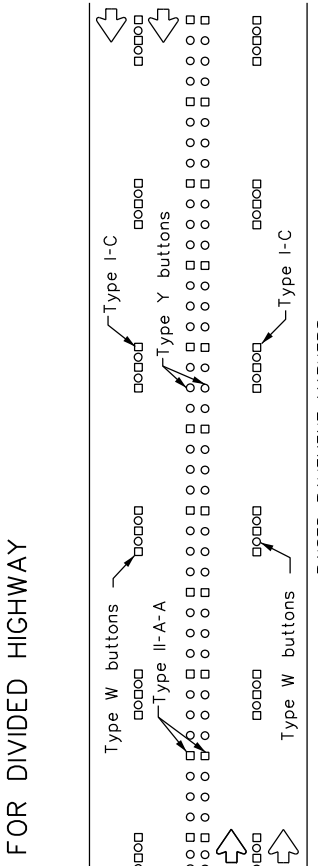
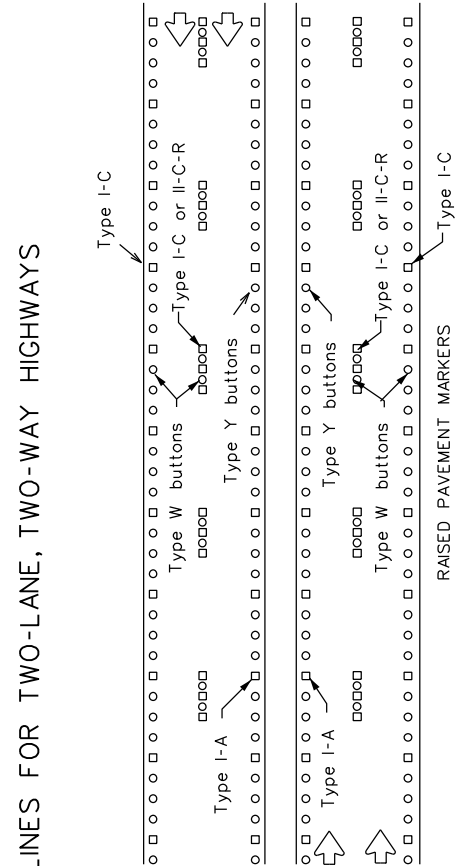
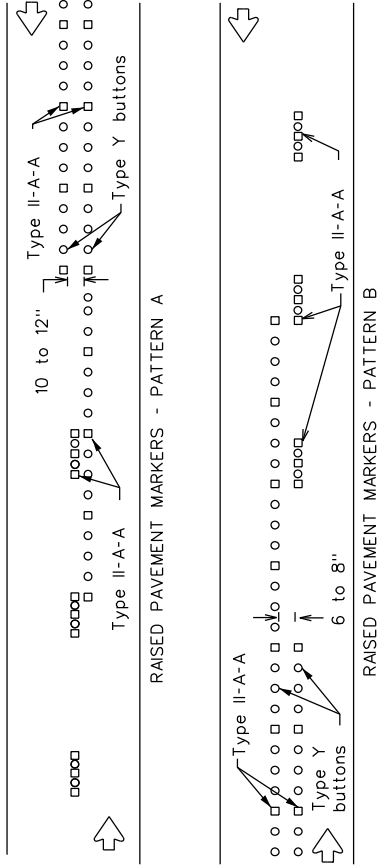

### STANDARD WORK ZONE PAVEMENT MARKINGS DETAILS

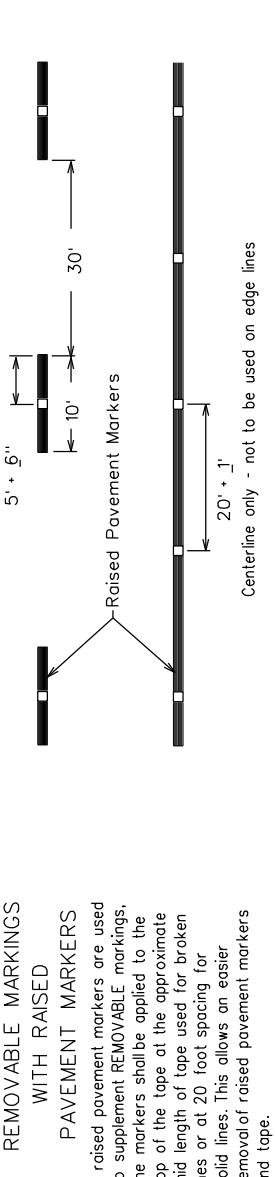
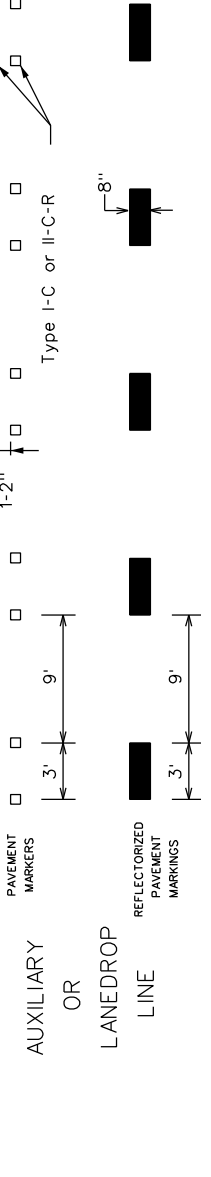
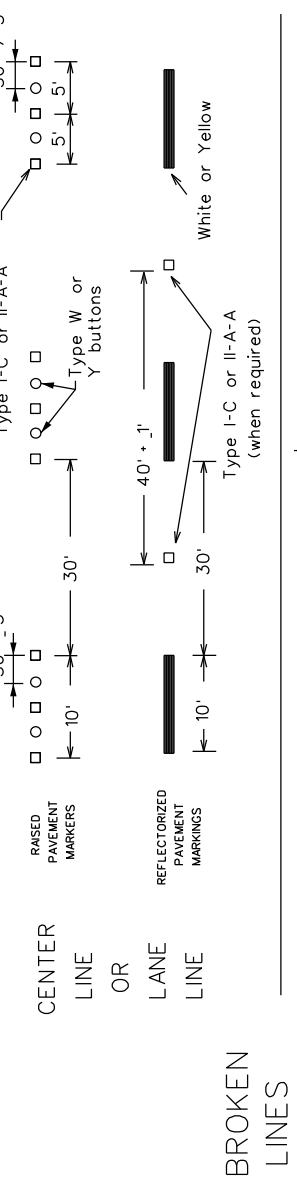
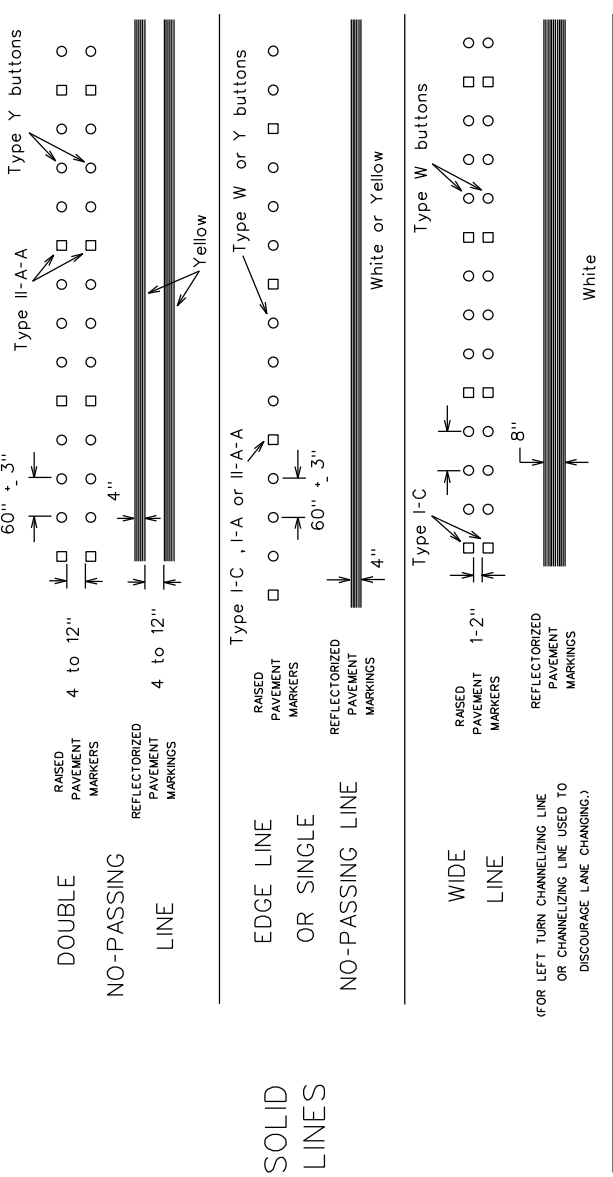

If raised pavement markers are used to supplement REMOVABLE markings, the markers shall be applied to the top of the tape at the approximate mid length of tape used for broken lines or at 20 foot spacing for solid lines. This allows an easier removal of raised pavement markers and tape.

Centerline only - not to be used on edge lines

SHEET 12 OF 12

Texas Department of Transportation

**BARRICADE AND CONSTRUCTION PAVEMENT MARKING PATTERNS**

BC(12)-21

Raised pavement markers used as standard pavement markings shall be from the approved products list and meet the requirements of Item 672 "RAISED PAVEMENT MARKERS."

FILE:	bc-21.dgn	DNK: TXDOT	CK: TXDOT	HW: TXDOT	CHK: TXDOT
DATE:	February 1998	CONT: SECT	JOB: 001	HIGHWAY: US0075	
REVISIONS:	1-97 9-07 5-21	DIST: 2-98 7-13	COUNTY: COLLIN	SHEET NO: 20	

DISCLAIMER: The use of this standard is governed by the "Texas Engineering Practice Act". No warranty of any kind is made by TXDOT for any purpose whatsoever. TXDOT assumes no responsibility for the conversion of this standard to other formats or for incorrect results or for damages resulting from its use.



DISCLAIMER:  
The use of this standard is governed by the "Texas Engineering Practice Act". No warranty of any kind is made by TxDOT for any purpose whatsoever. TxDOT assumes no responsibility for the conversion of this standard to other formats or for incorrect results or for damages resulting from its use.

**LEGEND**

	Type 3 Barricade	Channelizing Devices (CDs)
	Truck Mounted Attenuator (TMA)	Channelizing Devices
	Portable Changeable Message Sign (PCMS)	Channelizing Devices
	Traffic Flow	Channelizing Devices
	Flagger	Channelizing Devices

Posted Speed	Formula	Minimum Desirable Taper Lengths "L"			Suggested Maximum Spacing of Channelizing Devices		Suggested Longitudinal Buffer Space "B"
		10'	11'	12'	On a Taper	On a Tangent	
45		450'	495'	540'	45'	90'	195'
50		500'	550'	600'	50'	100'	240'
55	L = WS	550'	605'	660'	55'	110'	295'
60		600'	660'	720'	60'	120'	350'
65		650'	715'	780'	65'	130'	410'
70		700'	770'	840'	70'	140'	475'
75		750'	825'	900'	75'	150'	540'
80		800'	880'	960'	80'	160'	615'

\*\* Taper lengths have been rounded off.  
L-Length of Taper(FT) W-Width of Offset(FT)  
S-Posted Speed(MPH)

**TYPICAL USAGE**

MOBILE	SHORT DURATION	SHORT TERM STATIONARY	INTERMEDIATE TERM STATIONARY	LONG TERM STATIONARY
	✓			

**GENERAL NOTES**

- Place channelizing devices in the gore at 20' spacing.
- See the Standard Highway Sign Design for Texas (SHSD) for sign details.
- The PCMS may be omitted when a permanent DMS sign is available in an appropriate location to display a similar message as called for on the PCMS.
- When it is determined that a through lane should be closed in addition to the exit ramp, refer to TCP(6-4) for traffic control details.
- Truck mounted attenuator is required.
- The PCMS may be omitted if replaced with a "RAMP CLOSED" AHEAD (CW20RP-3D) Sign.
- Roadway ADT should be greater than 10,000.

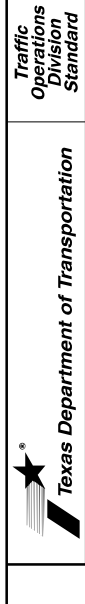

**WORK IN EXIT GORE FOR ADT GREATER THAN 10,000**

**TCP(6-8) - 14**

FILE: tcp6-8.dgn	DN: TxDOT	CK: TxDOT	DW: TxDOT	CK: TxDOT
© TxDOT February 2014	CONT: 6465	SECT: 17	JOB: 001	HIGHWAY: US0075
REVISIONS	DIST: 001	COUNTY: COLLIN	SHEET NO: 21	

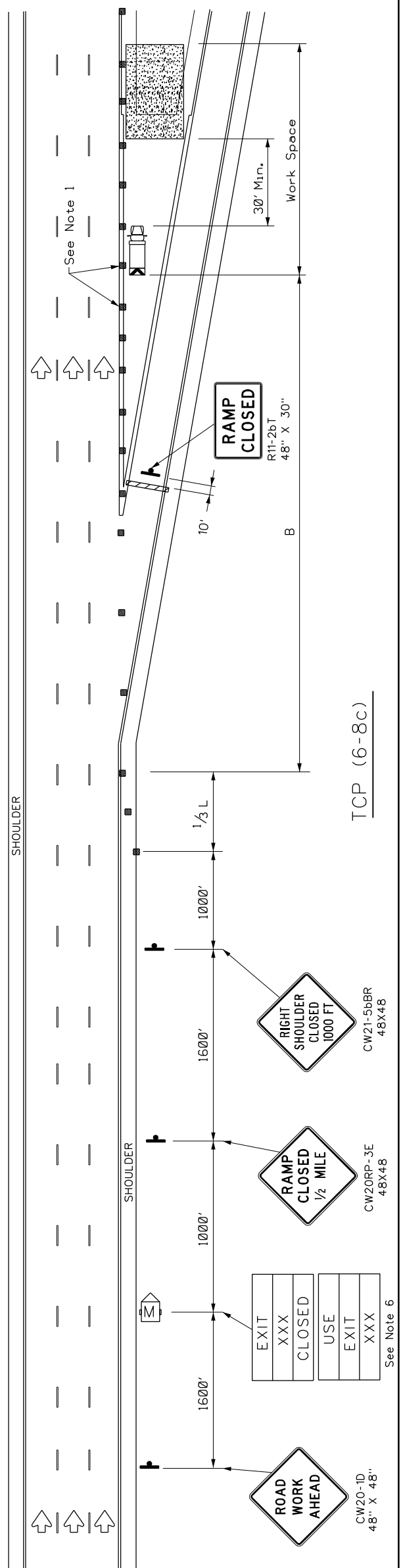
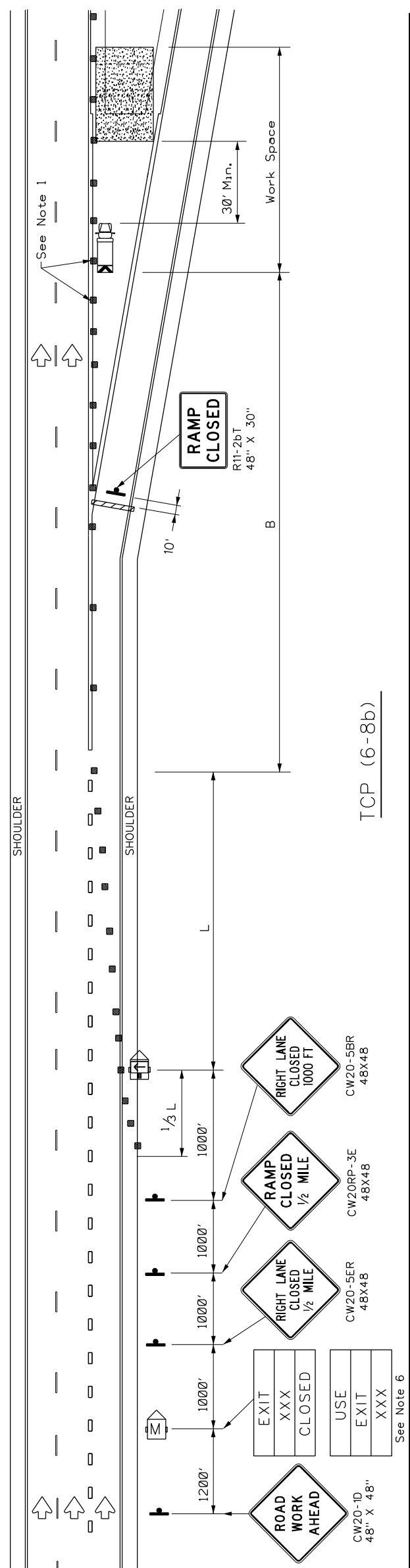
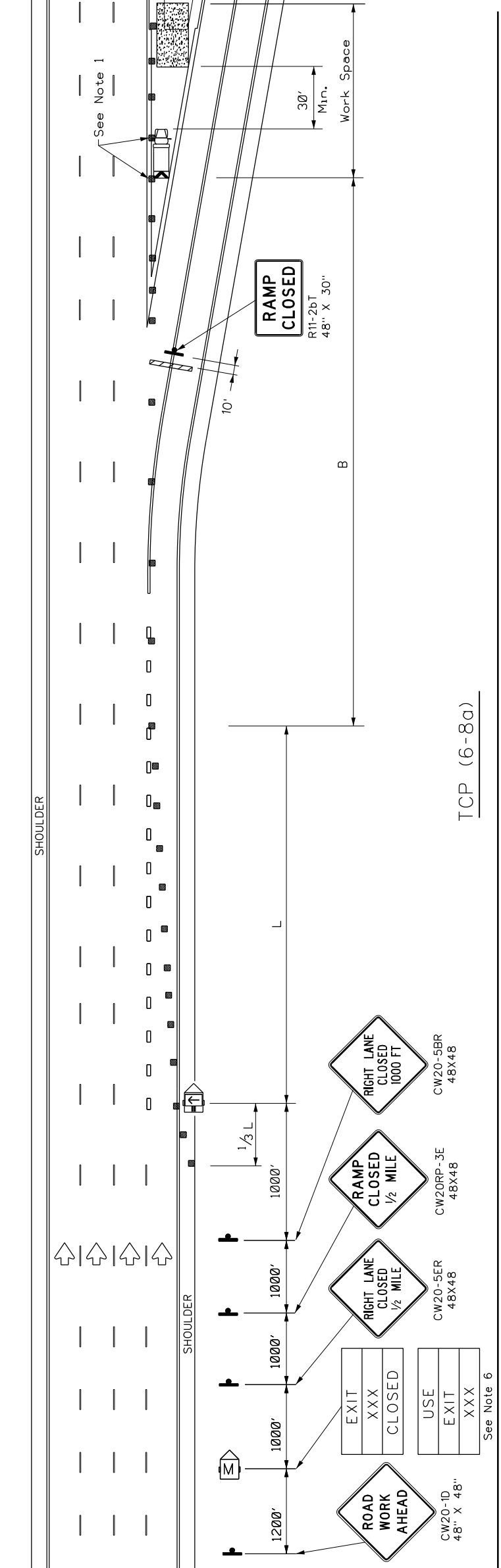

**SIGN SUPPORT DESCRIPTIVE CODES**

(Descriptive Codes correspond to project estimate and quantities sheets)

SM RD SGN ASSM TY XXXXX(X)XX(X-XXXX)

Post Type \_\_\_\_\_

- FRP - Fiberglass Reinforced Plastic Pipe (see SMD(FRP))
- TWT - Thin-Walled Tubing (see SMD(TWT))
- 10BWG - 10 BWG Tubing (see SMD(SLIP-1) to (SLIP-3))
- S80 - Schedule 80 Pipe (see SMD(SLIP-1) to (SLIP-3))

Number of Posts (1 or 2) \_\_\_\_\_

Anchor Type \_\_\_\_\_

- UA - Universal Anchor - Concreted (see SMD(FRP) and (TWT))
- UB - Universal Anchor - Bolted down (see SMD(FRP) and (TWT))
- WS - Wedge Anchor Steel - (see SMD(TWT))
- WP - Wedge Anchor Plastic (see SMD(TWT))
- SA - Slipbase - Concreted (see SMD(SLIP-1) to (SLIP-3))
- SB - Slipbase - Bolted Down (see SMD(SLIP-1) to (SLIP-3))

Sign Mounting Designation \_\_\_\_\_

- P - Prefab. "Plain" (see SMD(SLIP-1) to (SLIP-3), (TWT), (FRP))
  - T - Prefab. "T" (see SMD(SLIP-1) to (SLIP-3), (TWT))
  - U - Prefab. "U" (see SMD(SLIP-1) to (SLIP-3))
- IF REQUIRED, \_\_\_\_\_
- TEXT or 2EXT - Number of Extensions (see SMD(SLIP-1) to (SLIP-3), (TWT))
  - BM - Extruded Wind Beam (see SMD(SLIP-1) to (SLIP-3))
  - WC - 1.12 \* /ft Wing Channel (see SMD(SLIP-1) to (SLIP-3))
  - EXAL - Extruded Aluminum Sign Panels (see SMD(SLIP-3))

No more than 2 sign posts should be located within a 7 ft. circle.

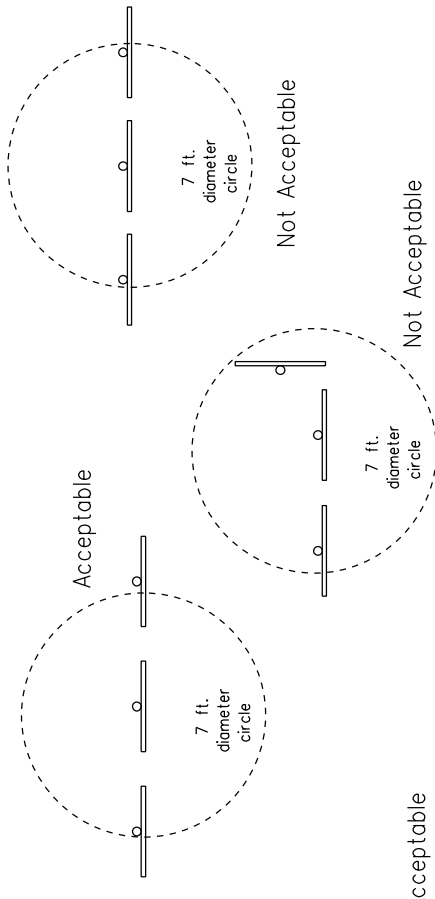

**REQUIRED CLEARANCE FOR BREAKAWAY SUPPORT**

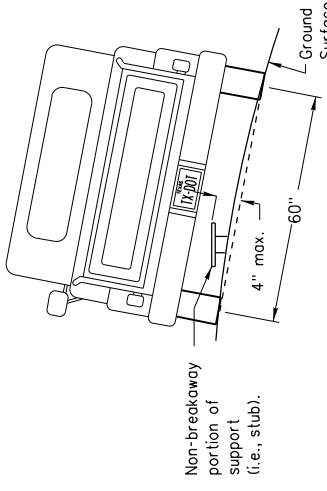

To avoid vehicle undercarriage snagging, any substantial remains of a breakaway support, when it is broken away, should not project more than 4 inches above a 60-inch chord (i.e., typical space between wheelpaths).

**SIGN LOCATION**

**PAVED SHOULDERS**

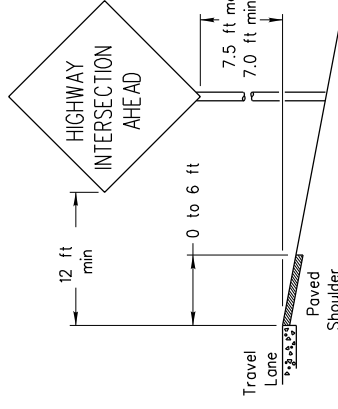

**LESS THAN 6 FT. WIDE**

When the shoulder is 6 ft. or less in width, the sign must be placed at least 12 ft. from the edge of the travel lane.

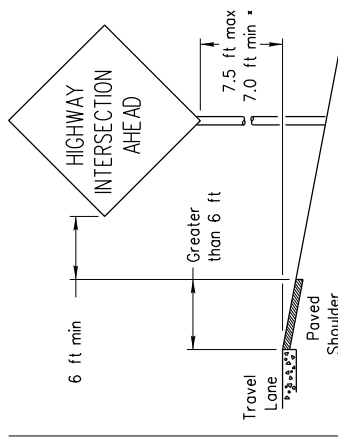

**GREATER THAN 6 FT. WIDE**

When the shoulder is greater than 6 ft in width, the sign must be placed at least 6 ft. from the edge of the shoulder.

**BEHIND BARRIER**

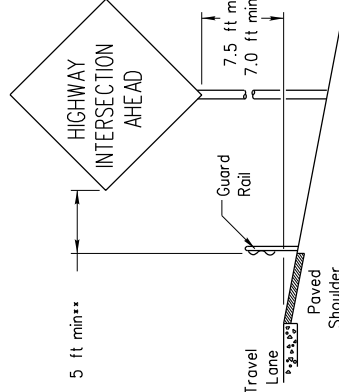

**BEHIND GUARDRAIL**

\*\*Sign clearance based on distance required for proper guard rail or concrete barrier performance.

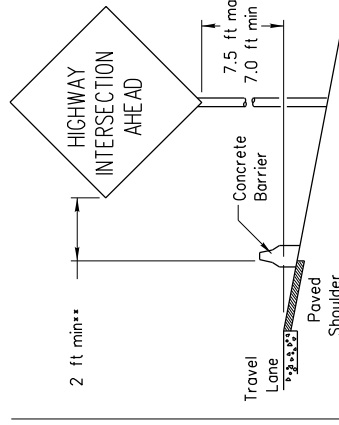

**BEHIND CONCRETE BARRIER**

**TYPICAL SIGN ATTACHMENT DETAIL**

**Single Signs**

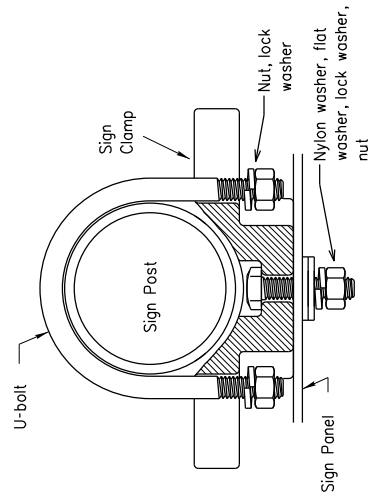

Bolts used to mount sign panels to the clamp are 5/16-18 UNC galvanized square head with nut, nylon washer, flat washer and lock washer. The bolt length is 1 inch for aluminum.

When two sign clamps are used to mount signs back-to-back, use a 5/16-18 UNC galvanized hex head per ASTM A307 with nut and helical-spring lock washer. The approximate bolt lengths for various post sizes and sign clamp types are given in the table at right. The bolt length may need to be adjusted depending upon field conditions.

Sign clamps may be either the specific size clamp or the universal clamp.

**Back-to-Back Signs**

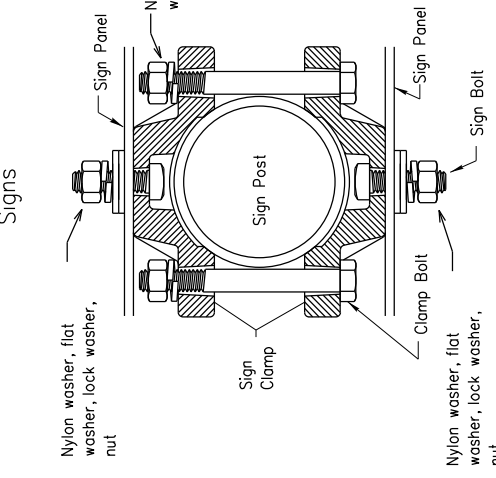

Pipe Diameter	Specific Clamp	Universal Clamp
2" nominal	3"	3 or 3 1/2"
2 1/2" nominal	3 or 3 1/2"	3 1/2 or 4"
3" nominal	3 1/2 or 4"	4 1/2"

**SIGNS WITH PLAQUES**

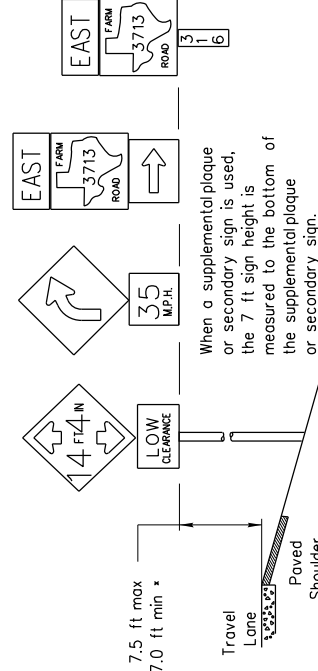

**CURB & GUTTER OR RAISED ISLAND**

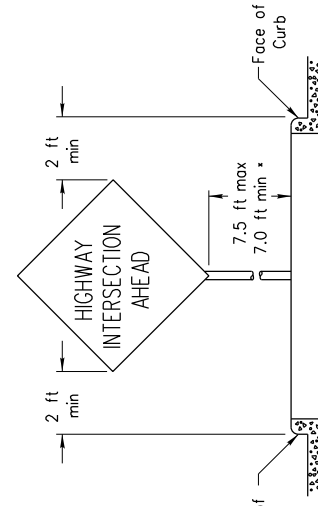

**RESTRICTED RIGHT-OF-WAY**

(When 6 ft min. is not possible.)

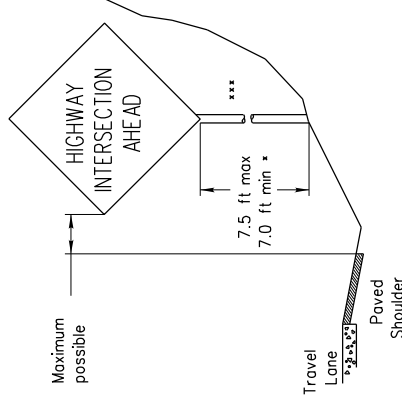

Right-of-way restrictions may be created by rocks, water, vegetation, forest, buildings, a narrow island, or other factors.

In situations where a lateral restriction prevents the minimum horizontal clearance from the edge of the travel lane, signs should be placed as far from the travel lane as practical.

\*\*\* Post may be shorter if protected by guardrail or if Engineer determines the post could not be hit due to extreme slope.

**T-INTERSECTION**

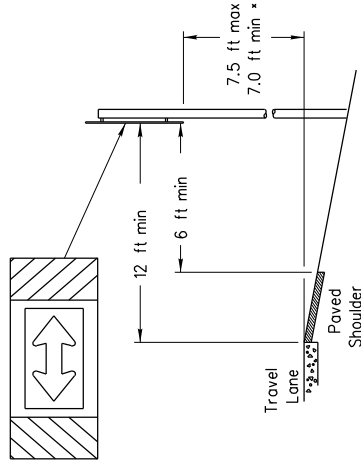

When this sign is needed at the end of a two-lane, two way roadway, the right edge of the sign should be in line with the centerline of the roadway. Place as close to ROW as practical.

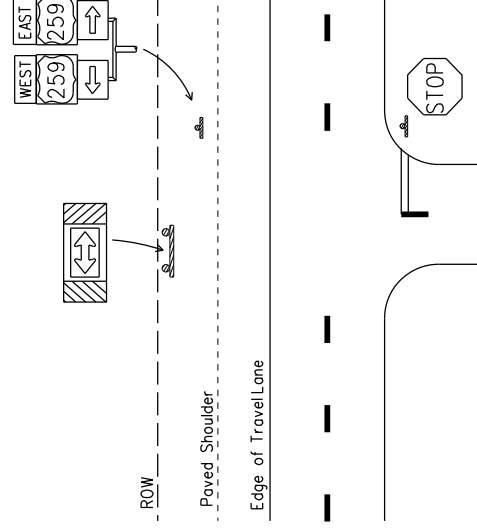

\* Signs shall be mounted using the following condition that results in the greatest sign elevation:

- (1) a minimum of 7 to a maximum of 7.5 feet above the edge of the travel lane or
- (2) a minimum of 7 to a maximum of 7.5 feet above the grade of the base of the support when sign is installed on the backslope.

The maximum values may be increased when directed by the Engineer.

See the Traffic Operations Division website for detailed drawings of sign clamps, Triangular Signpost System components and Wedge Anchor System components.

The website address is:

<http://www.txdot.gov/publications/traffic.htm>

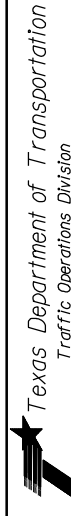

**SIGN MOUNTING DETAILS  
SMALL ROADSIDE SIGNS  
GENERAL NOTES & DETAILS**

SMD(GEN)-08

9-08	REVISONS	DATE	BY	CHK	APP
9-08	TXDOT	JULY 2002	TXDOT	TXDOT	TXDOT
CONT	SECT	JOB	HIGHWAY	PROJECT NO.	SHEET NO.
6465	17	001	US00075		22
DIST	COUNTY	COLLIN			



# TRIANGULAR SLIPBASE INSTALLATION GENERAL REQUIREMENTS

## NOTE

There are various devices approved for the Triangular Slipbase System. Please reference the Material Producer List for approved slip base systems. [http://www.txdot.gov/business/producer\\_list.htm](http://www.txdot.gov/business/producer_list.htm) The devices shall be installed per manufacturers' recommendations. Installation procedures shall be provided to the Engineer by Contractor.

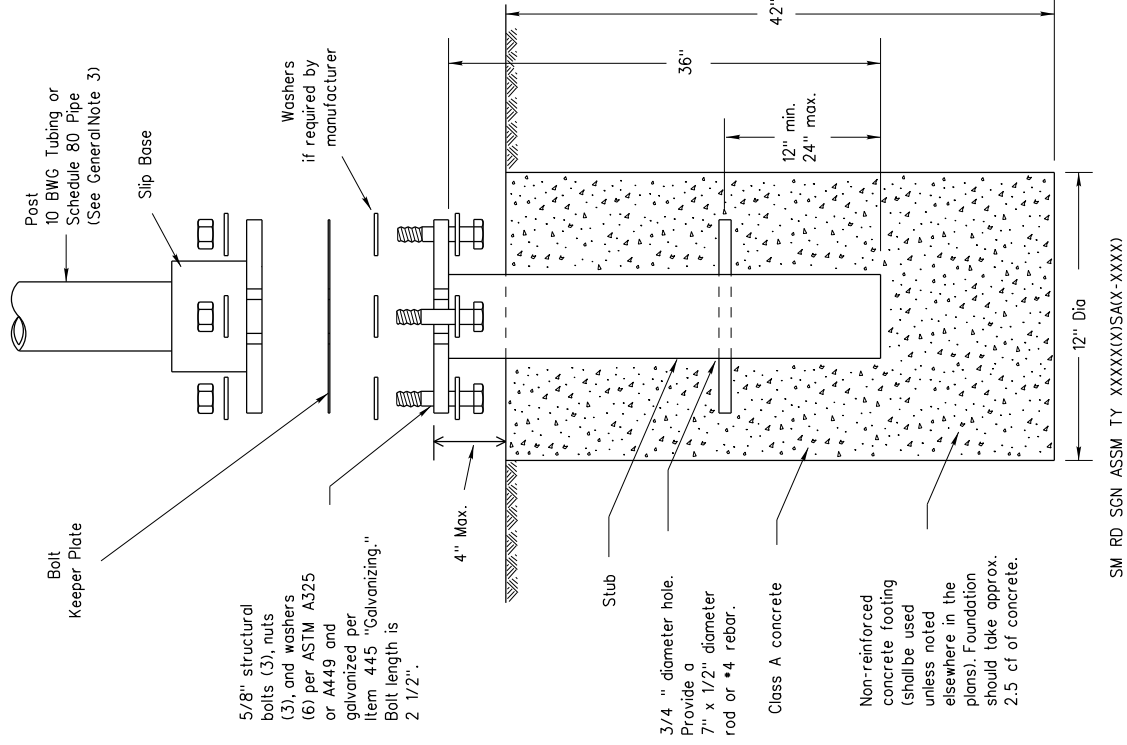

SM RD SGN ASSM TY XXXXX(X)SAX-XXXX

## CONCRETE ANCHOR

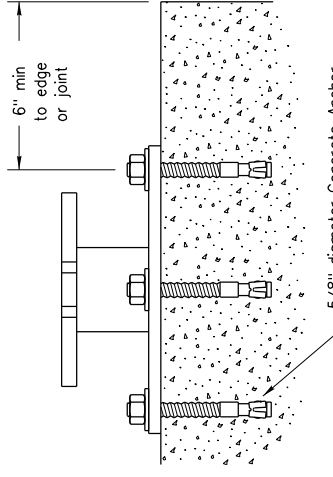

SM RD SGN ASSM TY XXXXX(X)SB(X)-XXXX

Concrete anchor consists of 5/8" diameter stud bolt with UNC series bolt threads on the upper end. Heavy hex nut per ASTM A563, and hardened washer per ASTM F436. The stud bolt shall have a minimum yield and ultimate tensile strength of 50 and 75 KSI, respectively. Nuts, bolts and washers shall be galvanized per Item 445. "Galvanizing." Adhesive type anchors shall have stud bolts installed with Type III epoxy per DMS-6100. "Epoxyes and Adhesives." Adhesive anchors may be loaded after adequate epoxy cure time per the manufacturer's recommendations. Top of bolt shall extend at least flush with top of the nut when installed. The anchor, when installed in 4000 psi normal-weight concrete with a 5 1/2" minimum embedment, shall have a minimum allowable tension and shear of 3900 and 3100 psi, respectively.

## GENERAL NOTES:

- Slip base shall be permanently marked to indicate manufacturer. Method, design, and location of marking are subject to approval of the TxDOT Traffic Standards Engineer.
- Material used as post with this system shall conform to the following specifications:
  - 10 BWG Tubing (2.875" outside diameter)
  - 0.134" nominal wall thickness
  - Seamless or electric-resistance welded steel tubing or pipe
  - Steel shall be HSLAS Gr 55 per ASTM A1011 or ASTM A1008
  - Other steels may be used if they meet the following:
    - 55,000 PSI minimum yield strength
    - 70,000 PSI minimum tensile strength
    - 20% minimum elongation in 2"
  - Wall thickness (uncoated) shall be within the range of 0.122" to 0.138"
  - Outside diameter (uncoated) shall be within the range of 2.867" to 2.883"
  - Galvanization per ASTM A123 or ASTM A653 G210. For precoated steel tubing (ASTM A653), recoat tube outside diameter weld seam by metalizing with zinc wire per ASTM B833.
  - Schedule 80 Pipe (2.875" outside diameter)
  - 0.276" nominal wall thickness
  - Steel tubing per ASTM A500 Gr C
  - Other seamless or electric-resistance welded steel tubing or pipe with equivalent outside diameter and wall thickness may be used if they meet the following:
    - 46,000 PSI minimum yield strength
    - 62,000 PSI minimum tensile strength
    - 21% minimum elongation in 2"
  - Wall thickness (uncoated) shall be within the range of 0.248" to 0.304"
  - Outside diameter (uncoated) shall be within the range of 2.855" to 2.895"
  - Galvanization per ASTM A123
- See the Traffic Operations Division website for detailed drawings of sign clamps and Texas Universal Triangular Slipbase System components. The website address is: <http://www.txdot.gov/publications/Traffic.htm>
- Sign supports shall not be spliced except where shown. Sign support posts shall not be spliced.

## ASSEMBLY PROCEDURE

### Foundation

- Prepare 12-inch diameter by 42-inch deep hole. If solid rock is encountered, the depth of the foundation may be reduced such that it is embedded a minimum of 18 inches into the solid rock.
- The Engineer may permit batches of concrete less than 2 cubic yards to be mixed with a portable, motor-driven concrete mixer. For small placements less than 0.5 cubic yards, hand mixing in a suitable container may be allowed by Engineer. Concrete shall be Class A.
- Push the pipe end of the slip base stub into the center of the concrete. Rotate the stub back and forth while pushing it down into the concrete to assure good contact between the concrete and stub.
- Continue to work the stub into the concrete until it is between 2 to 4 inches above the ground.
- Plumb the stub. Allow a minimum of 4 days to set, unless otherwise directed by the Engineer.
- The triangular slipbase system is multidirectional and is designed to release when struck from any direction.

### Support

- Cut support so that the bottom of the sign will be 7 to 7.5 feet above the edge of the travelway (i.e., edge of the closest lane) when slip plate is below the edge of pavement or 7 to 7.5 feet above slip plate when the slip plate is above the edge of the travelway. The cut shall be plumb and straight.
- Attach sign to support using connections shown. When multiple signs are installed on the same support, ensure the minimum clearance between each sign is maintained. See SMD(SLIP-2) for clearances based on sign types.

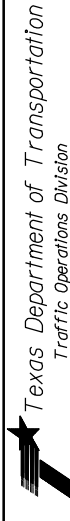

# SIGN MOUNTING DETAILS SMALL ROADSIDE SIGNS TRIANGULAR SLIPBASE SYSTEM

SMD(SLIP-1)-08

© TxDOT July 2002	REV: 001	JOB: 001	HWY: US0075
9-08	REV: 001	JOB: 001	HWY: US0075
DIST: DAL	COUNTY: COLLIN	SHEET NO: 23	

DISCLAIMER: The use of this standard is governed by the "Texas Engineering Practice Act". No warranty of any kind is made by TxDOT for any purpose whatsoever. TxDOT assumes no responsibility for the conversion of this standard to other formats or for incorrect results or damages resulting from its use.

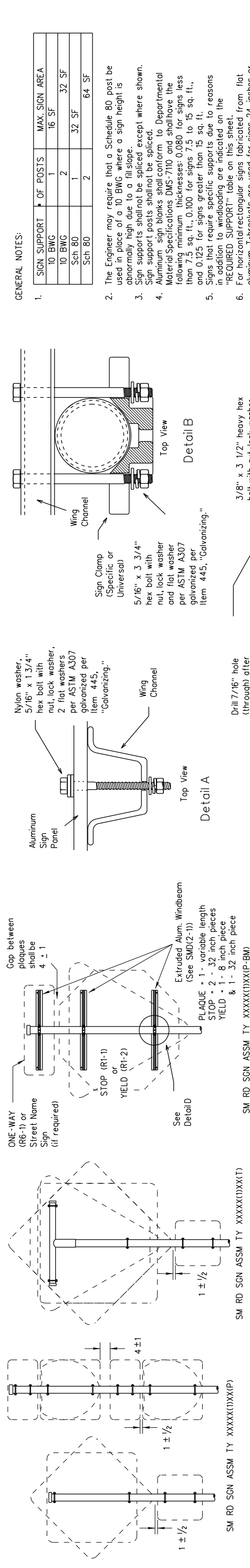

GENERAL NOTES:

SIGN SUPPORT	OF POSTS	MAX. SIGN AREA
10 BWG	1	16 SF
10 BWG	2	32 SF
Sch 80	1	32 SF
Sch 80	2	64 SF

- The Engineer may require that a Schedule 80 post be used in place of a 10 BWG where a sign height is abnormally high due to a fill slope.
- Sign supports shall not be spliced except where shown.
- Aluminum sign blanks shall conform to Departmental Material Specifications DMS-7110 and shall have the following minimum thicknesses: 0.080 for signs less than 7.5 sq. ft., 0.100 for signs 7.5 to 15 sq. ft., and 0.125 for signs greater than 15 sq. ft.
- Signs that require specific supports due to reasons in addition to windloading are indicated on the "REQUIRED SUPPORT" table on this sheet.
- For horizontal rectangular signs fabricated from flat aluminum, T-brackets are used for signs 24 inches or less in height. U-brackets are used for signs of greater height.
- When two triangular slipbase supports are used to support a single sign, they shall not be "rigidly" connected to each other except through the sign panel. This will allow each support to act independently when impacted by an errant vehicle.
- Wing channel shall meet ASTM A 1011 SS Gr 50 and be galvanized per ASTM A 123.
- Excess pipe, wing channel, or windbeam shall be cut off so that it does not extend beyond the sign panel (i.e., excess support shall not be visible when the sign is viewed from the front.) Repair galvanized coating at cut support ends per Item 445, "Galvanizing."
- Additional route markers may be added vertically, provided the total sign area does not exceed the maximum allowable amount per Note 1.
- Additional sign clamp required on the "I-bracket" post for 24 inch height signs. Place the clamp 3 inches above bottom of sign when possible.
- Post open ends shall be fitted with Friction Caps.
- Sign blanks shall be the sizes and shapes shown on the plans.

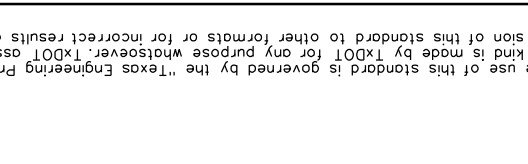
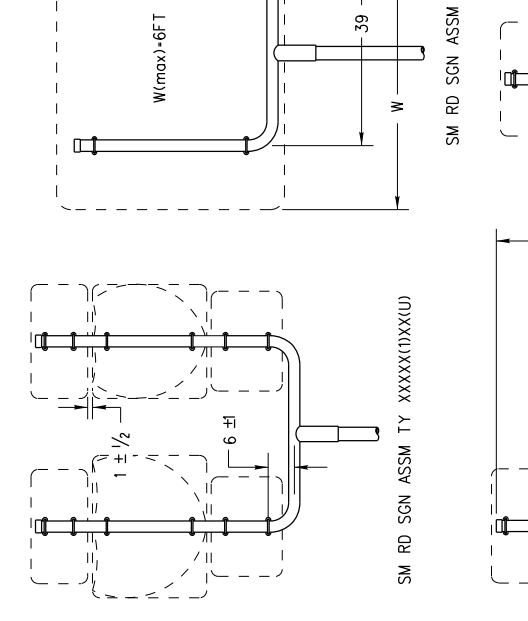
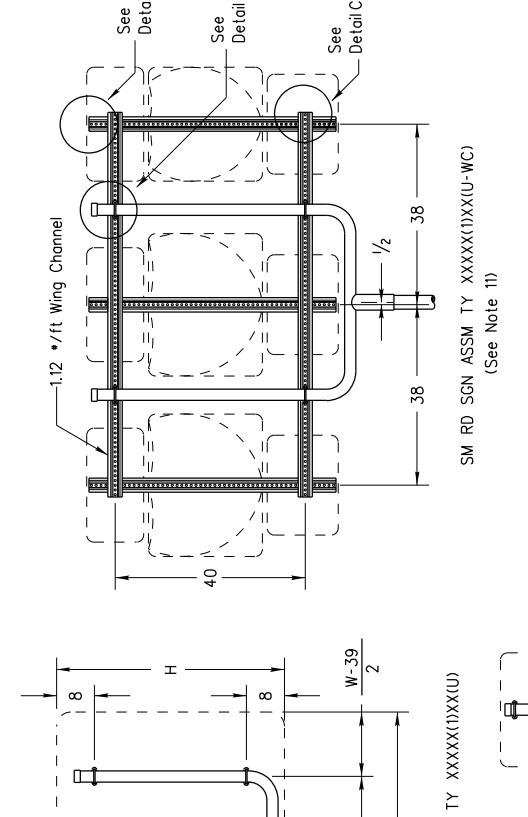
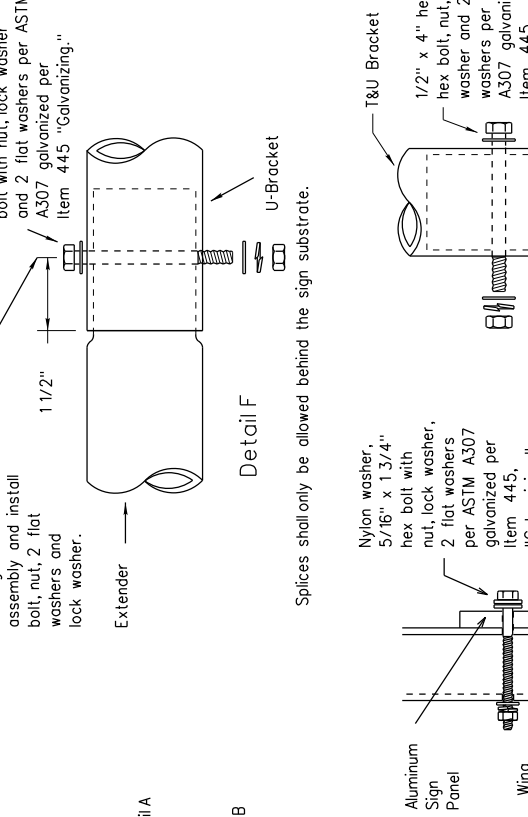
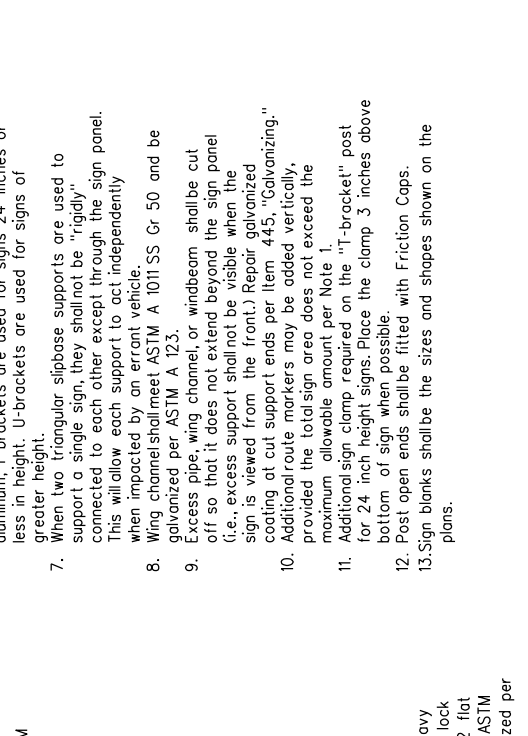
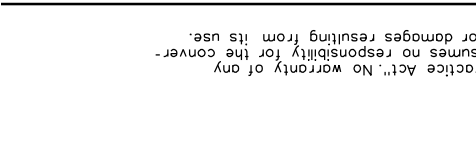
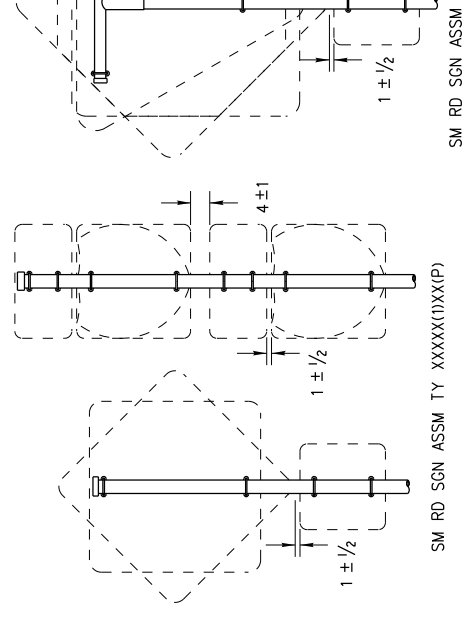
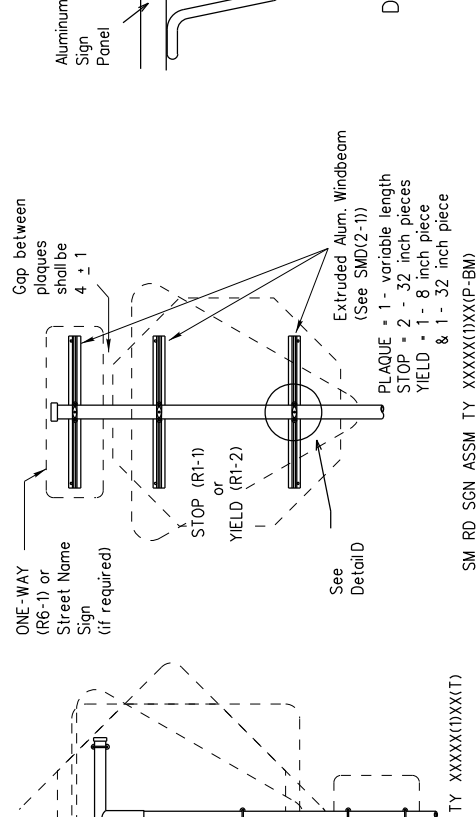
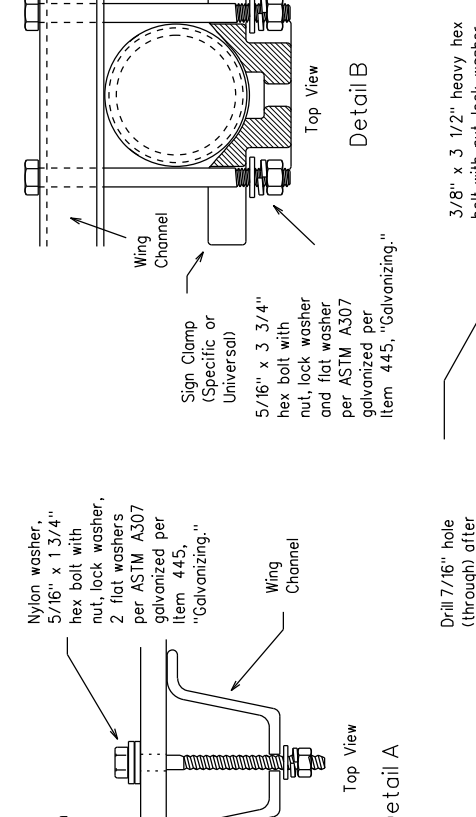

REQUIRED SUPPORT

SIGN DESCRIPTION	SUPPORT
48-inch STOP sign (R1-1)	TY 10BWG(1)XX(T)
60-inch YIELD sign (R1-2)	TY 10BWG(1)XX(T)
48x16-inch ONE-WAY sign (R6-1)	TY 10BWG(1)XX(T)
36x48, 48x36, and 48x48-inch signs	TY 10BWG(1)XX(T)
48x60-inch signs	TY S80(1)XX(T)
48x48-inch signs (diamond or square)	TY 10BWG(1)XX(T)
48x60-inch signs	TY S80(1)XX(T)
48-inch Advance School X-ing sign (S1-1)	TY 10BWG(1)XX(T)
48-inch School X-ing sign (S2-1)	TY 10BWG(1)XX(T)
Large Arrow sign (W1-6 & W1-7)	TY 10BWG(1)XX(T)

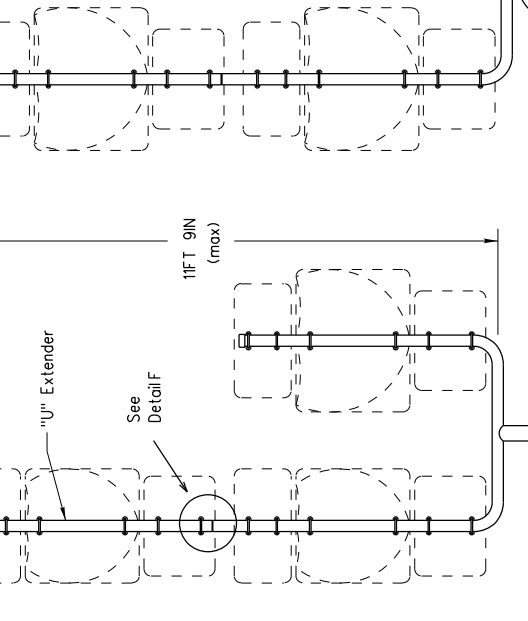
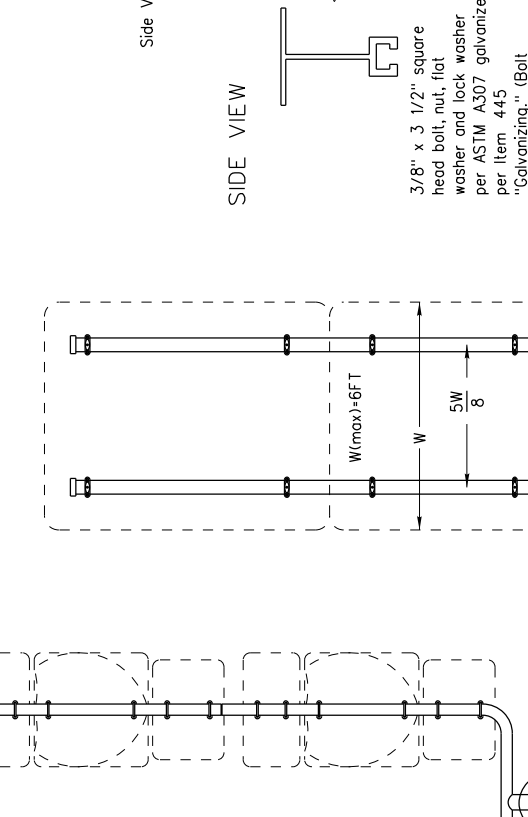
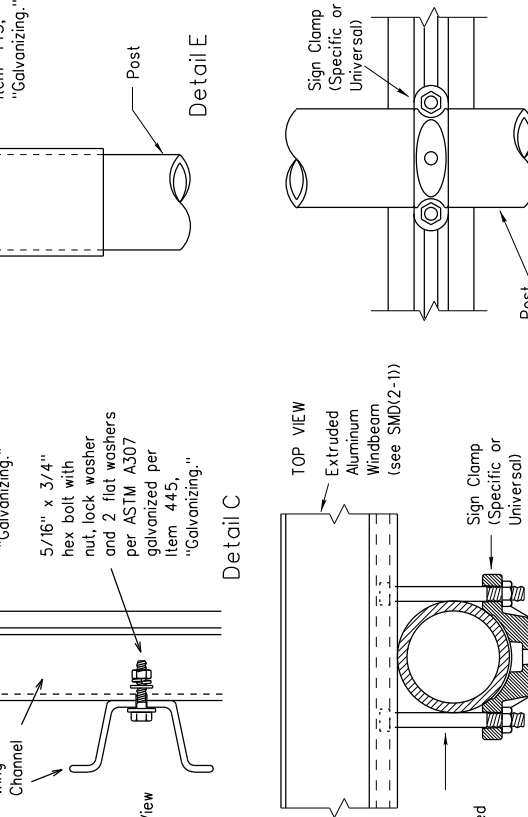

Texas Department of Transportation  
Traffic Operations Division

SIGN MOUNTING DETAILS  
SMALL ROADSIDE SIGNS  
TRIANGULAR SLIPBASE SYSTEM  
SMD(SLIP-2)-08

DATE	REVISED	BY	CHK	DATE	PROJECT
9-08					

DATE	REVISED	BY	CHK	DATE	PROJECT
9-08					

DATE	REVISED	BY	CHK	DATE	PROJECT
9-08					

DATE	REVISED	BY	CHK	DATE	PROJECT
9-08					

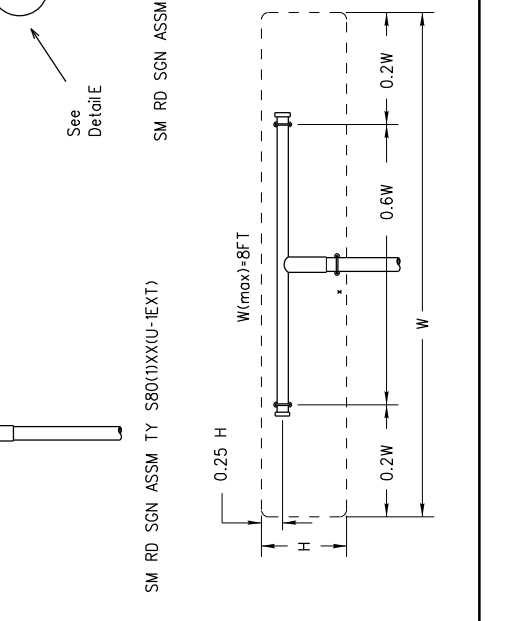
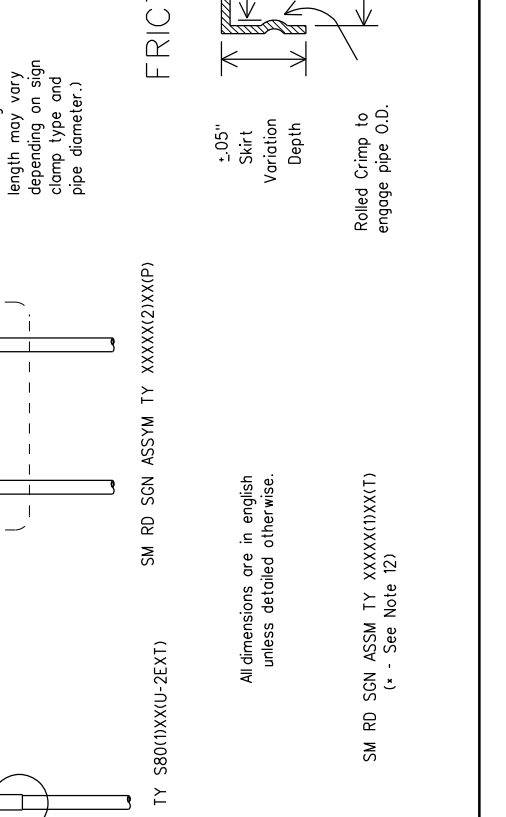
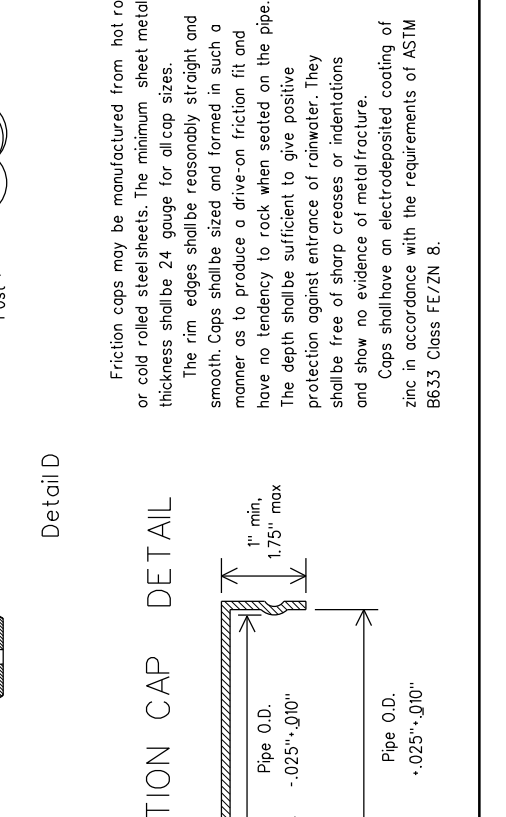

DISCLAIMER: The use of this standard is governed by the "Texas Engineering Practice Act". No warranty of any kind is made by TxDOT for any purpose whatsoever. TxDOT assumes no responsibility for the conversion of this standard to other formats or for incorrect results or damages resulting from its use.

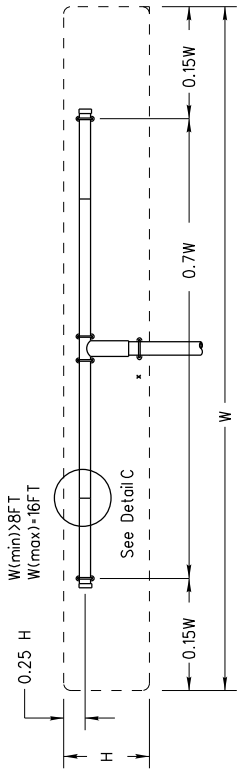

SM RD SGN ASSM TY XXXXX(1)XX(T-2EXT)  
(- See Note 12)

Extruded Alum. Windbeam (See Detail D on SMD (SLIP-2)) or 1.12 +/- ft Wing Channel (See Detail A and Detail B)

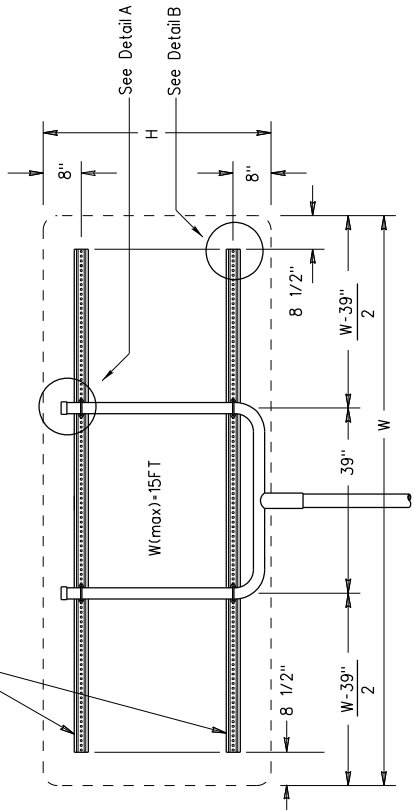

SM RD SGN ASSM TY XXXXX(1)XX(U-XX)

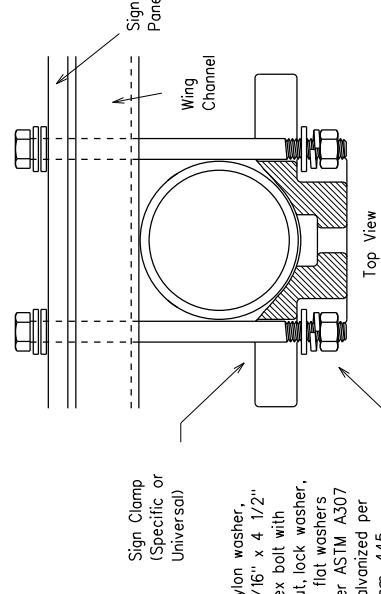

Top View  
Detail A

Nylon washer, 5/16" x 4 1/2" hex bolt with nut, lock washer, 2 flat washers per ASTM A307 galvanized per Item 445, "Galvanizing."

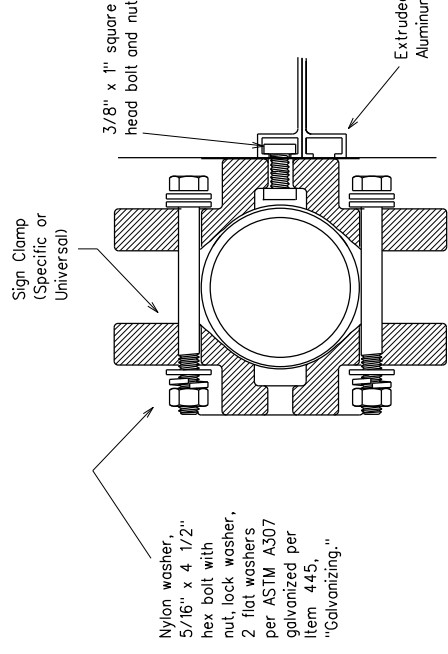

Detail D  
EXTRUDED ALUMINUM SIGN WITH T BRACKET

Nylon washer, 5/16" x 4 1/2" hex bolt with nut, lock washer, 2 flat washers per ASTM A307 galvanized per Item 445, "Galvanizing."

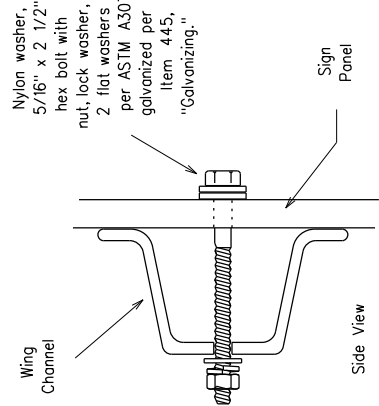

Detail B

Detail C

Splices shall only be allowed behind the sign substrate.

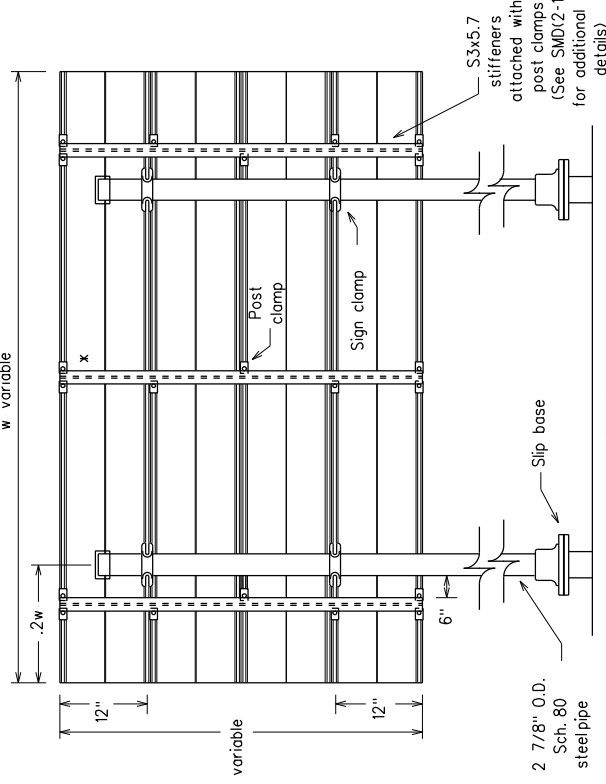

Typical Sign Mount

SM RD SGN ASSM TY S80(2)XX(IP-EXAL)  
\* Additional stiffener placed at approximate center of signs when sign width is greater than 10'.

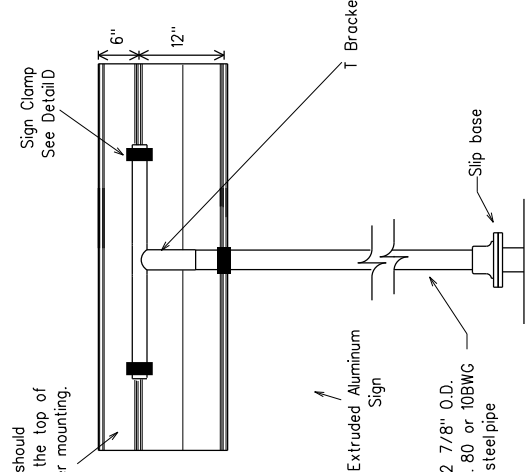

Extruded Aluminum Sign  
With T Bracket

Use Extruded Alum. Windbeam as stiffeners See SMD (2-1) for additional details See Detail E for clamp installation

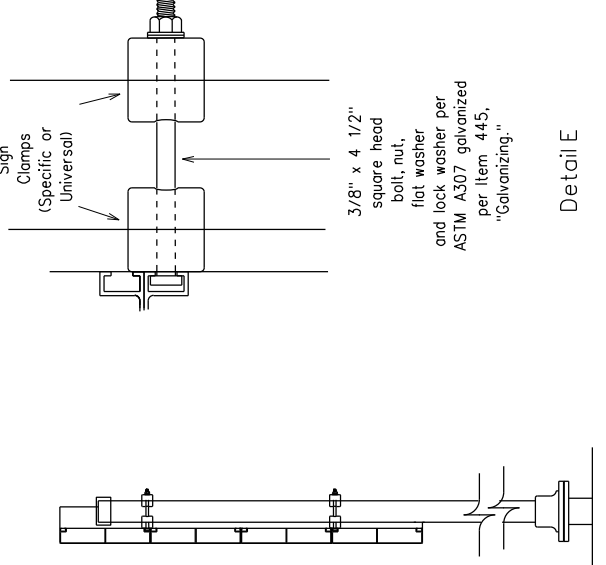
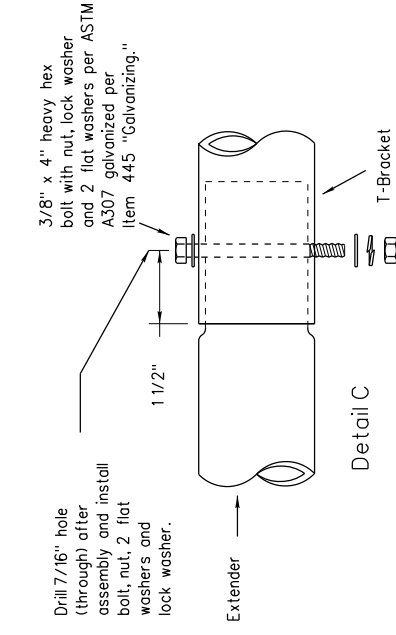

Detail E

SIGN SUPPORT	# OF POSTS	MAX. SIGN AREA
10 BWG	1	16 SF
10 BWG	2	32 SF
Sch 80	1	32 SF
Sch 80	2	64 SF

- The Engineer may require that a Schedule 80 post be used in place of a 10 BWG where a sign height is abnormally high due to a fill slope.
- Sign supports shall not be spliced except where shown.
- Aluminum sign blanks shall conform to Departmental Material Specifications DMS-7110 and shall have the following minimum thicknesses: 0.080 for signs less than 7.5 sq. ft., 0.100 for signs 7.5 to 15 sq. ft., and 0.125 for signs greater than 15 sq. ft.
- Signs that require specific supports due to reasons in addition to windloading are indicated on the "REQUIRED SUPPORT" table on this sheet.
- For horizontal rectangular signs fabricated from flat aluminum, T-brackets are used for signs 24 inches or less in height. U-brackets are used for signs of greater height.
- When two triangular slipbase supports are used to support a single sign, they shall not be "rigidly" connected to each other except through the sign panel. This will allow each support to act independently when impacted by an errant vehicle.
- Wing channel shall meet ASTM A 1011 SS Gr 50 and be galvanized per ASTM A 123.
- Excess pipe, wing channel, or windbeam shall be cut off so that it does not extend beyond the sign panel (i.e., excess support shall not be visible when the sign is viewed from the front.) Repair galvanized coating at cut support ends per Item 445, "Galvanizing."
- Sign blanks shall be the sizes and shapes shown on the plans.
- Additional sign clamp required on the "T-bracket" post for 24 inch high signs. Place the clamp 3 inches above bottom of sign when possible.
- Post open ends shall be fitted with Friction Caps.

REQUIRED SUPPORT	
SIGN DESCRIPTION	SUPPORT
48-inch STOP sign (R1-1)	TY 10BWG(1)XX(T)
60-inch YIELD sign (R1-2)	TY 10BWG(1)XX(T)
48x16-inch ONE-WAY sign (R6-1)	TY 10BWG(1)XX(IP-BM)
36x48, 48x36, and 48x48-inch signs	TY 10BWG(1)XX(T)
48x60-inch signs	TY 10BWG(1)XX(T)
48x48-inch signs (diamond or square)	TY S80(1)XX(T)
48x60-inch signs	TY 10BWG(1)XX(T)
48-inch Advance School X-ing sign (S1-1)	TY S80(1)XX(T)
48-inch School X-ing sign (S2-1)	TY 10BWG(1)XX(T)
Large Arrow sign (W1-6 & W1-7)	TY 10BWG(1)XX(T)

Texas Department of Transportation  
Traffic Operations Division

**SIGN MOUNTING DETAILS**  
**SMALL ROADSIDE SIGNS**  
**TRIANGULAR SLIPBASE SYSTEM**  
**SMD(SLIP-3)-08**

© TxDOT July 2002	DK: TxDOT	CK: TxDOT	CK: TxDOT
9-08	REV: 001	JOB: US00075	HIGHWAY
DIST: 17	COUNTY: COLLIN	SHEET NO: 25	