

**STATE OF TEXAS  
DEPARTMENT OF TRANSPORTATION**

REQUIRED SIGNS SHALL BE IN ACCORDANCE WITH BC (1) - 07 THRU BC (12) - 07 AND THE "TEXAS MANUAL ON UNIFORM TRAFFIC CONTROL DEVICES".

STATE PROJECT NO.			
RMC 6440-15-001			
CONT	SECT	JOB	HIGHWAY
6440	15	001	IH 20, ETC.
DIST	COUNTY		SHEET NO.
02	PALO PINTO		1

**PLANS OF PROPOSED  
HIGHWAY ROUTINE MAINTENANCE CONTRACT**

ROADSIDE MOWING, HERBICIDE AND LITTER REMOVAL

PROJECT NO. RMC 6440-15-001

HIGHWAY: IH 20

LIMITS OF WORK: PALO PINTO COUNTY

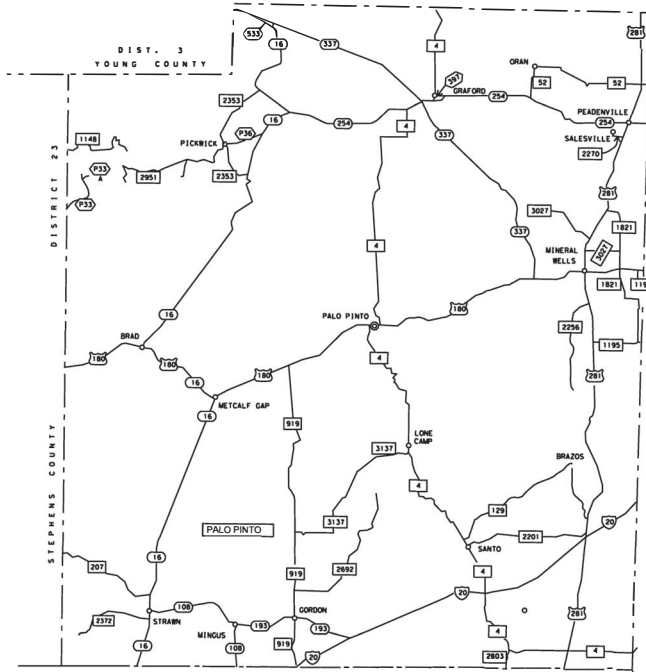

DocuSigned by: **TING** 5/10/2023  
*Kory D. Lowe* P.E.  
 6536CC8BE43A490  
 AREA ENGINEER

DocuSigned by: **TING** 5/11/2023  
*Danny M. Henderson* P.E.  
 F759E84E0E3C45C  
 DISTRICT MAINTENANCE ENGINEER

DocuSigned by: **ETTING** 5/11/2023  
*Janet Crawford*  
 1FDBBD41B5E486  
 OF MAINTENANCE

EXCEPTIONS: NONE  
 EQUATIONS: NONE  
 RAILROAD CROSSINGS: NONE

SPECIFICATIONS ADOPTED BY THE TEXAS DEPARTMENT OF TRANSPORTATION, NOVEMBER 1, 2014 AND SPECIFICATION ITEMS LISTED AND DATED AS FOLLOWS, SHALL GOVERN ON THIS PROJECT.

**GENERAL**

SHEET NO.	DESCRIPTION
1	TITLE SHEET
2	INDEX SHEET
3A-3P	GENERAL NOTES
4	ESTIMATE AND QUANTITIES
5	PROJECT LIMITS
6	PROJECT LOCATION MAP

**TCP STANDARDS**

SHEET NO.	DESCRIPTION
7	TCP (1-1) -18*
8	TCP (1-2) -18*
9	TCP (1-3) -18*
10	TCP (1-4) -18*
11	TCP (1-5) -18*
12	TCP (2-1) -18*
13	TCP (2-2) -18*
14	TCP (2-3) -18*
15	TCP (2-4) -18*
16	TCP (2-6) -18*

**TCP STANDARDS (CONT.)**

SHEET NO.	DESCRIPTION
17	TCP (3-1) -13*
18	TCP (3-2) -13*
19	TCP (3-5) -18*
20	TCP (5-1) -18*
21	TCP (6-1) -12*
22	TCP (6-2) -12*
23	TCP (6-3) -12*
24	TCP (6-4) -12*
25	TCP (6-8) -14*
26	TCP (6-9) -14*

**BC STANDARDS**

SHEET NO.	DESCRIPTION
27	BC (1) -21*
28	BC (2) -21*
29	BC (3) -21*
30	BC (4) -21*
31	BC (5) -21*
32	BC (6) -21*
33	BC (7) -21*
34	BC (8) -21*
35	BC (9) -21*
36	BC (10) -21*
37	BC (11) -21*
38	BC (12) -21*

**WORK ZONE STANDARDS**

SHEET NO.	DESCRIPTION
39	WZ (RS) -22*
40	RS-TCP-05*

**MAINTENANCE STANDARDS**

SHEET NO.	DESCRIPTION
41	SMOWND-04
42	SMOWD-04

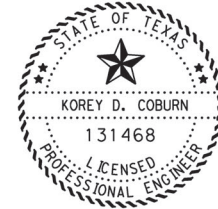

\*THE STANDARD SHEETS SPECIFICALLY IDENTIFIED ABOVE HAVE BEEN ISSUED BY ME AND ARE APPLICABLE TO THIS PROJECT.  
DocuSigned by:

*Corey D. Coburn*, PE 5/10/2023  
6538CC8BE43A490, PE DATE



**INDEX SHEET**

REVISIONS	FED. RD. DIV. NO.	STATE PROJECT NO.		SHEET NO.
	6	RMC	6440	15 001
	STATE	DISTRICT	COUNTY	
	TEXAS	02	PARKER	
	CONTROL	SECTION	JOB	HIGHWAY NO.
	6440	15	001	IH 20, ETC.

**Project Number:** RMC 6440-15-001

**Sheet 3A**

**County:** Palo Pinto

**Control:** 6440-15-001

**Highway:** IH 20, ETC.

**GENERAL NOTES:**

**Special Notes:**

Contractor questions on this project are to be addressed to the following individual(s):

Area Engineer: Korey Coburn [Korey.Coburn@txdot.gov](mailto:Korey.Coburn@txdot.gov)  
 Asst. Area Engineer: Gary Beck [Gary.Beck@txdot.gov](mailto:Gary.Beck@txdot.gov)  
 Design Manager: Ester Kuhn [Ester.Kuhn@txdot.gov](mailto:Ester.Kuhn@txdot.gov)

Questions may be submitted via the Letting Pre-Bid Q&A web page. The webpage can be accessed from the Notice to Contractors dashboard located at the following Address: <https://tableau.txdot.gov/views/ProjectInformationDashboard/NoticetoContractors>

All contractor questions will be reviewed by the Engineer. All questions and any corresponding responses that are generated will be posted through the same Letting Pre-Bid Q&A web page.

The Letting Pre-Bid Q&A web page for each project can be accessed by using the dashboard to navigate to the project you are interested in by scrolling or filtering the dashboard using the controls on the left. Hover over the blue hyperlink for the project you want to view the Q&A for and click on the link in the window that pops up.

**General:**

Plans are required for this project. Plans may be obtained from one of the plan companies listed in the "Special Notice to Contractors", or viewed at Texas Department of Transportation's (TxDOT's) Internet site at <https://www.txdot.gov/business/letting-bids/plans-online.html>.

Contract Prosecution: Each contract awarded by the Department stands on its own and as such, is separate from other contracts. A Contractor awarded multiple contracts must be capable and sufficiently staffed to concurrently process and/or execute all contracts and work orders at the same time.

Furnish crew(s) and equipment capable of maintaining work in a continuous manner for the completion of the work listed on the work order.

Personnel will be experienced in items of work in the contract, which they will be performing. Safety vests and hard hats will be pre-approved and worn at all times when outside vehicles within the work area. Safety vests shall be Class III.

Provide and maintain a dedicated email address for receipt of work orders and correspondence throughout the term of this contract.

Project Description - This project consists of Roadside Mowing, Herbicide and Litter Removal on sections of highway within Palo Pinto County as shown in the contract and defined in these

**Project Number:** RMC 6440-15-001

**Sheet 3B**

**County:** Palo Pinto

**Control:** 6440-15-001

**Highway:** IH 20, ETC.

general notes and specifications. Coordinate all work through the Maintenance Supervisor or his representative. The names will be provided during the preconstruction meeting.

<b>Palo Pinto</b> Maintenance Supervisor 2400 US 180 West Mineral Wells, Texas 76067 (940)325-2414
--

Prior to mobilizing equipment into the Fort Worth District, all equipment will be clean and free of any debris from prior use in other districts or counties.

**Item 4.4 Changes In The Work.**

This contract may be extended for an additional period of seven hundred and thirty (730) days in accordance with Special Provision 004--001 .

**Item 5.3.2 Correction of Defective or Unauthorized Work.**

Re-mow areas, as directed, that do not meet the standards as outlined in this contract at Contractor's expense. Notification will be given within two (2) working days, not including Saturdays, Sundays or legal holidays. Upon notification, the Contractor will have two (2) working days, not including Saturdays, Sundays or legal holidays to complete all re-mow areas. If work is not completed within the established time frame, all other mowing operations will cease and time charges will continue until all areas are re-mowed.

**Item 6.7. Department-Furnished Material.**

A Herbicide Application Record Book will be supplied by the Department. All other materials will be furnished by the contractor.

**Item 7.2.4. Public Safety and Convenience.**

Personal vehicles will not be parked within the right-of-way at any time, including any section closed to the traveling public. Operations will be curtailed or halted during special events that may result in delays or congestion to the traveling public. No work that restricts or interferes with traffic shall be allowed from 3:00 pm on the day preceding the Holiday or Event to 9:00 am on the day after the Holiday or Event. The following Holiday/Event Lane closure restriction requirements apply to this project:

**Project Number:** RMC 6440-15-001

**Sheet 3C**

**County:** Palo Pinto

**Control:** 6440-15-001

**Highway:** IH 20, ETC.

Holiday Lane Closure Restrictions	
New Year's Eve and New Year's Day (December 31 through January 1)	3 PM December 30 through 9 AM January 2
Easter Holiday Weekend (Friday through Sunday)	3PM Thursday through 9 AM Monday
Memorial Day Weekend (Friday through Monday)	3 PM Thursday through 9 AM Tuesday
Independence Day (July 3 through July 5)	3 PM July 2 through 9 AM July 6
Labor Day Weekend (Friday through Monday)	3 PM Thursday through 9 AM Tuesday
Thanksgiving Holiday (Wednesday through Sunday)	3 PM Tuesday through 9 AM Monday
Christmas Holiday (December 23 through December 26)	3 PM December 22 through 9 AM December 27

No lane closures within approximately 1 mile proximity (based on potential impact) of major retail traffic generators (i.e. malls) (Thanksgiving Day through January 2).

Modifications to Lane Closure / Work Restrictions:

Submit a request in writing for approval by the Engineer a minimum of 10 days in advance of implementing a change to lane closure restrictions.

When deemed necessary, the Engineer will lengthen, shorten, or otherwise modify lane closure restrictions as traffic conditions warrant.

**Item 8.1. Prosecution of Work.**

This contract has both site specific and non-site-specific work. Notification of site-specific work will be executed by initial work order. Work will begin no later than 7 calendar days from issuance of the work order letter and continuously processed to completion unless otherwise approved by the Engineer.

Notify section supervisor twenty-four (24) hours in advance of the date and time the Contractor plans to commence work.

Notification of the non-site-specific work will be executed by a call-out work order. This contract will have multiple and concurrent work orders. No more than two (2) work orders will be issued to be performed at the same time.

**Project Number:** RMC 6440-15-001

**Sheet 3D**

**County:** Palo Pinto

**Control:** 6440-15-001

**Highway:** IH 20, ETC.

All work order thereafter shall begin operations within seventy-two (72) hours after verbal and/or written notification.

**Item 8.3. Computation of Contract Time for Completion.**

Time will be charged in accordance with Item 8.3.1.5 Calendar Day in the Standard Specifications For Construction And Maintenance Of Highways, Streets, And Bridges.

Working days for work orders will be calculated by dividing quantities by production rate. A fraction of the day will be rounded up to the next whole number. If the total number of working days is not used during the completion of the work order the working days will not be carried forward to a subsequent work order. Each work order will define the total number of working days for that particular work order as defined in Section 8.3.1.4. Standard Work Week in the Standard Specifications For Construction And Maintenance Of Highways, Streets, And Bridges.

The Engineer has the right to grant additional time or terminate a work order if inordinate amounts of adverse weather conditions occur. These conditions may be roadway icing, excessive rainfall, or any other weather condition that could prevent the contractor from completing a work order in the time specified. If a work order is terminated, the Contractor will only be paid for the work that has been satisfactorily completed on the work order.

**Item 8.3.2. Restricted Work Hours.**

Perform work as shown below, unless otherwise approved:

<i>Daytime Work</i>
30 Min. after daylight – 30 Min. before dark Monday – Friday Saturday – Optional
Excluding National Holidays

Contractor has the option of working on Saturdays or State holidays with forty-eight (48) hour advance notice. Work on Sundays or National holidays will not be permitted without written permission of the Engineer.

**Item 8.5. Project Schedules.**

Prepare the schedules as a Bar Chart. Schedules must be submitted by the twentieth (20th) day of every month.

**Item 8.6. Failure to Complete Work on Time.**

The response time specified in the contract is an essential element. Liquidated damages will be assessed when the Contractor fails to begin work within the specified response times for any Item(s). The dollar amount specified in this contract will be deducted from any money due or to become due for any Items(s) and will continue to be deducted for each day until work begins. This amount will be assessed not as a penalty, but as liquidated damages.

**Project Number:** RMC 6440-15-001**Sheet 3E****County:** Palo Pinto**Control:** 6440-15-001**Highway:** IH 20, ETC.

Failure to complete a project in the working days specified in the work order, time charges will continue for each working day until work is completed for that work order. The amount assessed for liquidated damages will be based on the total value of the original contract, in accordance with Special Provision 000-1243, not the estimated amount on individual work orders.

When a minimum production rate is shown in the plans, liquidated damages will be charged for each working day the minimum production rate is not met.

**Item 500. Mobilization.**

Mobilization will be paid by the lump sum for all site-specific work. All non-site-specific work will be paid by the callout.

**Item 502. Barricades, Signs, and Traffic Handling.**

Provide equipment such as trucks, trailers, autos, etc., with highly visible omni-directional warning flashing lights. These lights will be used within the work zone at all times. Provide forward facing arrow panel on lead vehicles when working in a continuous turn lanes. The Engineer will approve all equipment and vehicles prior to use.

All traffic control, with the exception of Special Specification 6185 Truck Mounted Attenuator (TMA) and Trailer Attenuator (TA), is subsidiary to the various bid items in accordance with Section 502.4.1.6.

Mount signs on their own stands. Attach two (2) brightly colored safety flags to each sign. Do not hang or lean signs on or against any other sign post or delineator post. Erect signs in such a manner that they will not obstruct the traveling public's view of normal roadway signing or obstruct sight distance at intersections or curves.

Shadow vehicles equipped with Truck-Mounted Attenuators (TMA's) are required as shown on all Traffic Control Plan (TCP) Standards. Striping will be required on the back panel of truck mounted attenuators, and will be 8 inches of red and white stripes placed on an inverted "V" design. Sheeting will conform to departmental material Specification D-9-8300, Type "C".

Provide signing and traffic control in compliance with the Texas Manual on Uniform Traffic Control Devices (TMUTCD), latest edition, and the appropriate traffic control method as outlined in the TMUTCD, and elsewhere in the plans.

Portable Changeable Message Signs (PCMS) shown on the Traffic Control Plan sheets (TCP's) as "optional" will be required on this contract. Additional PCMS may be required and will be paid for under the appropriate bid item. PCMS shall be placed a minimum of 48 hours in advance of work on all roadways and 7 days in advance of work on Tier 1 roadways.

Lane closures will be required on roadways as indicated in the plans and will be a maximum of two (2) miles from beginning of taper to end of closure. Lane closures will also be required on roadways allowing mobile operations in areas with inadequate field of view as determined by the Engineer.

General Notes

Sheet E

**Project Number:** RMC 6440-15-001**Sheet 3F****County:** Palo Pinto**Control:** 6440-15-001**Highway:** IH 20, ETC.

Provide a Department Approved Truck Mounted Attenuator (TMA) behind all equipment overhanging roadway travel lanes. Trailer all slow moving vehicles (designed to operate 25mph or less) crossing freeway main lanes.

Dedicated personnel must be on duty to maintain barricades.

Equipment and materials will not be left within thirty feet (30') of the travel lane during non-working hours.

Submit a lighting plan for nighttime work for TxDOT review and approval. Provide Multi-Directional Lighting Device (MDLD) for nighttime work with the following quality requirements:

- Provide a 2000 watt (minimum) SIROCCO lighting balloon, Airstar lighting or equivalent
- It is the intent of the MDLD lighting to supplement the Portable Road Light and Power Unit used to illuminate work areas during night work hours.
- Provide MDLD units which can self-inflate and are capable of illuminating approximately 15,000 sq. ft.
- Provide MDLD units of 1.1 meter horizontal diameter and capable of withstanding 60 mph winds when fully inflated and operating.
- Provide MDLD units with two (2) 1,000 watt halogen bulbs recommended by the manufacturer.

**Item 502.4.2. Law Enforcement Personnel.**

If off-duty uniformed police officers are to be used during daytime hours, obtain prior approval from the Engineer. Nighttime closures will require off-duty uniformed police officer(s). All off-duty uniformed police officers will have marked police vehicle(s) with jurisdiction and full police power in the city or county where the work is being performed. Determine and agree upon the number of off-duty uniformed police officers in advance of the work. Off-duty police officers will be paid for through force account. Fill out Form 318 "Daily Report on Law Enforcement" to check against invoice for officers.

**Item 730. Roadside Mowing**

The District Maintenance Office will notify the maintenance section at the beginning of the growing season as to when mowing operations may commence. Work order(s) will not be issued before the notice to commence date and will not be issued before May 1st of the growing season.

Set mower cutting height to achieve a vegetation height of six inches (6") with a tolerance of one inch (1") after the vegetation has been mowed. Any hand trimming not completed within the stated period, all mowing operations shall cease until all hand trimming complies, time charges

General Notes

Sheet F

**Project Number:** RMC 6440-15-001**Sheet 3G****County:** Palo Pinto**Control:** 6440-15-001**Highway:** IH 20, ETC.

will continue. Hand trimming is considered a part of the normal day calculations. Litter Removal must be done immediately prior to mowing or after as directed by the Engineer. Any litter missed or shredded by the mowers must be picked up within 48 hours following mowing operations. All mowing operations shall cease until all litter is picked up; time charges will continue. The required production rate for roadside mowing, strip mowing, and hand trimming is 200 acres/day.

Existing cable barrier fence in the center median of divided highways within the limits of this contract may be present. The contractor is responsible for inspecting the highways within this contract to determine what type of mowing equipment will be necessary for mowing these narrow areas. Conventional batwing mowers may not be suitable or acceptable for mowing along the narrow side of cable barrier fence. Travel lane closures will not be permitted for mowing this narrow width area. Therefore, the contractor must utilize mowing equipment that will not encroach onto the shoulder or adversely affect traffic in the adjacent travel lanes. No pay adjustment will be made for mowing along cable barrier fence locations.

Ozone Action Days. As a result of TxDOT's concern for air quality and the seriousness of the current and anticipated problem, TxDOT has adopted a policy which addresses air quality as it relates to all aspects of the Department's operations.

The Texas Commission on Environmental Quality (TCEQ) is monitoring weather conditions daily in this region to forecast the probability of ozone formation. In the event weather conditions indicate that excessive ozone may occur on the following day, the National Weather Service will issue an air stagnation and ozone advisory to their subscribers. Radio, television, and print media will relay the advisory to the public.

On ozone action days the Contractor is encouraged to suspend all work. In the event that the Contractor chooses not to work on ozone action days, time will not be charged against the designated number of working days specified in the contract.

On ozone action days the Contractor is also encouraged to use alternative fuel vehicles and equipment. Information on next-day ozone action days will be available from the local maintenance sections of TxDOT after 4:00 p.m. or from the Engineer.

Begin spot mowing within 24 hours after verbal notification.

**Item 730.3.2.1. Strip Mowing.**

- Mowing width of 15 ft. – 1 pass with a 15 ft. mower and is measured and paid as 14 ft.
- Mowing width of 30 ft. – 2 passes with a 15 ft. mower and is measured and paid as 28 ft.
- Mowing width of 45 ft. – 3 passes with a 15 ft. mower and is measured and paid as 42 ft.

Re-mow areas, as directed, that do not meet the standards as outlined in this contract at Contractor's expense. Notification will be given within two (2) working days, not including Saturdays, Sundays or legal holidays. Upon notification, the Contractor will have two (2) working days, not including Saturdays, Sundays or legal holidays to complete all re-mow areas.

General Notes

Sheet G

**Project Number:** RMC 6440-15-001**Sheet 3H****County:** Palo Pinto**Control:** 6440-15-001**Highway:** IH 20, ETC.

If work is not completed within the established time frame, all other mowing operations will cease and time charges will continue until all areas are re-mowed.

*Slopes, ditches and channels.* Where standing water is present completely mow or hand trim any ditches or channels (including removal of cattails) less than four feet (4') wide that fall within the designated mowing area. For ditches or channels greater than four feet (4') wide that fall within the designated mowing area, mow or hand trim two feet (2') past the edge of the waterline on each side of the ditch unless otherwise directed. Mow or hand trim all ditches, channels, or watercourses where standing water is not present.

Delay mowing for a minimum of fourteen (14) days after herbicide application.

For mowing operations, furnish and install "MOWERS AHEAD" signs with flags in accordance with DMS 8310 "Flexible Roll-up Reflective Signs"

**Item 731. Herbicide Treatment**

The Engineer or designated licensed TxDOT personnel will determine the level of vegetation management to be used within the right of way on the tracts presented in this contract. The Engineer or designated licensed TxDOT personnel will direct the Contractor on the following in accordance with the latest edition of the TxDOT Herbicide Operations Manual:

- Location of application sites
- Timing of herbicide application
- Proper herbicide activity
- Selection of herbicides
- Proper application rates
- Proper application methods

Contractor's licensed personnel shall perform calibration of equipment in front of a designated TXDOT employee at least annually before work begins. If equipment parts are changed after breakdown, they must be recalibrated. This includes any herbicide application equipment used on TXDOT ROW including herbicide spray unit, trailer unit, handguns, backpacks, etc.

Work orders shall be provided and detail the location, chemical to use, and weed(s) to be controlled. Weed species to be treated and times include, but are not limited to:

General Notes

Sheet H

Project Number: RMC 6440-15-001

Sheet 3I

County: Palo Pinto

Control: 6440-15-001

Highway: IH 20, ETC.

Table 1  
Broadcast Application Guidelines—Item 731.7.1 and 731.7.2.5

Target/Type of Control Desired	Herbicide	Application Rate	Optimum Treatment Period	Comments
Johnson Grass Control	Roundup PROMAX®+ Outrider®	8 ounces + 1.33 ounces per acre	Early boot to early seedhead is a good time to make application. Apply while actively growing.	Flex-5. For use in Bahiagrass areas. Do not use Outrider® after October 15.
	Outrider®	1.33 ounces per acre + 1 quart Surfactant per 100 gallons of water		Flex-5. In areas where wildflowers are present or if brownout from RoundUP PROMAX® has been a problem. Do not use Outrider® after October 15.
		1 ounce of Outrider per 100 gallons of water + 1 quart of surfactant per 100 gallons of water		Handgun application
Roundup PROMAX®	2 parts water, 1 part RUPM OR 33% solution	Rotowiper®/Ropewick application		
Johnsongrass Control + Broadleaves (3-Way Mix)	Roundup PROMAX® + Escort® XP + Outrider®	8 ounces + 1 ounce + 1.33 ounces per acre		Overspray Operations/Flex 5 Spray Head Vista XRT® at 10 oz per acre may be substituted for Escort XP® in Bahiagrass ROW. If after July 31, do not apply Escort XP®, or Vista® XRT, as a broadcast application in the ROW. Spot treat problem areas using the Flex-5.

Project Number: RMC 6440-15-001

Sheet 3J

County: Palo Pinto

Control: 6440-15-001

Highway: IH 20, ETC.

Johnsongrass Control + Broadleaves (4-Way Mix)	Roundup PROMAX® + Escort® XP + Outrider® + Vista XRT®	8 ounces + 1 ounce + 1.33 ounces + 10 ounces per acre		If after July 31, do not apply Escort XP®, or Vista® XRT, as a broadcast application in the ROW. Spot treat problem areas using the Flex-5.
Hard-to-Control Johnsongrass	Target 6.6®	1.5 quarts per acre + 2 quarts of surfactant per 100 gallons of water		Overspray application. Temp needs to be at least 70°. Two applications, 30-60 days apart are needed; as long as Johnsongrass is green and actively growing.
Sunflower	Transline®	10 fluid ounces per acre + 2 quarts per 100 gallons of surfactant	Late Spring/ Early Summer	Overspray operations with Flex-5 boom. Apply before plants mature. Do not use Transline® after July 31 as overspray application on broadleaf plants.
		10 ounces per 100 gallons + 2 quarts per 100 gallons of surfactant		Handgun operations.
Musk Thistle	Transline®	10 fluid ounces per acre + 2 quarts per 100 gallons of surfactant	Early Spring	Overspray operations with Flex-5 boom. Do not use Transline® after July 31 as an overspray application for broadleaves.
		10 fluid ounces/100 gallons + 2 quarts/100 gallons of surfactant		Handgun operations.
Giant Ragweed (Blood weed)	Vista®XRT	10 fluid ounces per acre + 2 quarts surfactant per 100 gallons of water	Late Spring/ Early Summer	Overspray operations with Flex-5 boom. Apply before plants mature. Do not use Vista® XRT in the ROW after July 31st as overspray application.
		10 fluid ounces per 100 gallons + 2 quarts surfactant per 100 gallons of water		Handgun operations.

Project Number: RMC 6440-15-001

Sheet 3K

County: Palo Pinto

Control: 6440-15-001

Highway: IH 20, ETC.

Table 2  
Pavement Spray – Item 731.7.2 and 731.7.2.1.1

Target/Type of Control Desired	Herbicide	Application Rate	Optimum Treatment Period	Comments
Edge of Pavement, (Bare Ground edge of pavement application, no more than 6 inches from edge of road surface)	Roundup PROMAX® + Esplanade® 200 SC	3 quarts per acre + 4 ounces per acre	March through October OR when there is green & actively growing vegetation encroaching the pavement.	RoundUp PROMAX (short-term control) is combined with 4 ounces of Esplanade 200 SC (soil-residual control) to control vegetation in the Edge of Pavement.

Table 3  
Structures and Fixture Spray – Items 731.7.2.2, 731.7.2.3, 731.7.2.4 and 731.7.2.5

Target/Type of Control Desired	Herbicide	Application Rate	Optimum Treatment Period	Comments
Guardrail, delineators, mailboxes, signage (removal of tall weeds)	Roundup PROMAX®+ Escort® + Outrider®	8 ounces + 1 ounce + 1.33 ounces per acre	Apply after wildflower seed & before July 31 <sup>st</sup> or as directed by licensed TxDOT personnel.	Complete control (bare ground) beneath guardrails, under delineators and around sign supports is not recommended.
	Roundup PROMAX®+ Outrider®	8 ounces + 1.33 ounces per acre	Can be applied until October 15 <sup>th</sup> or as directed by licensed TxDOT personnel.	Vista® XRT at the rate of 10 ounces per acre can be combined with the three-way or two-way mixtures for the control of Giant Ragweed.

Project Number: RMC 6440-15-001

Sheet 3L

County: Palo Pinto

Control: 6440-15-001

Highway: IH 20, ETC.

The direct supervision affidavit will not relieve the license applicator of the responsibilities set forth under Item 731.3.

Trees, brush, grass, reeds, cane, and weeds are considered undesirable vegetation in Pavement Edges, Structures, and Fixtures. Broadcast application treatment must follow the same sequence as the previous mowing cycle. Herbicide Records Book will be supplied by the Department. All lines and boxes in the Herbicide Records Book will be filled out completely. A sample for proper record keeping is presented in the Herbicide Records Book. **Submit a copy of the herbicide records on the next business day following the application.** Submit a final copy of the herbicide records upon completion of each herbicide application.

**DRIFT CONTROL:**

Appropriate drift control must be used with all herbicides when using the truck handgun, fixture or Flex-5 booms. Drift control is not required when using backpack sprayers.

All other materials will be furnished by the contractor.

Delay mowing for a minimum of fourteen (14) days after herbicide application.

**Item 731.2 Materials.**

Use only approved chemicals, rates, and application procedures provided in the latest edition of the TxDOT Herbicide Operations Manual. Weed infestation/coverage on the included tracts is estimated at sixty (60%) percent of the total mowing acreage. The acreage for broadcast herbicide was estimated by using this percentage of the mowing acreage. Do not herbicide areas not infested with targeted weeds.

The use of dye is required unless otherwise directed by the Engineer. This item will not be paid for directly but will be subsidiary to the various items.

The production rates will be as follows:

- 10 MI/day - Pavement Edges, Structures and Fixtures
- 80 AC/day – Broadcast Application

**Item 731.7.2 Pavement Edges, Structures and Fixtures**

Apply herbicide to eliminate all grass and weeds encroaching into or on pavement mainlane, shoulder edges, riprap, and structures including retaining walls, sidewalks, islands, traffic barriers, raised medians, curbs, mow strips, and any other concrete or asphalt structure as directed.

Edge of pavement, retaining walls, sidewalks, islands, traffic barriers, mow strips and other appurtenances shall be sprayed with a band of herbicide and no more than 6 inches on the vegetation surrounding the pavement or structure.

**Item 731.8. Measurement.** Pavement Edges, Structures and Fixtures will be measured by the Centerline Mile. Centerline Mile is defined as the distance measured from the beginning point to the ending point as shown in the plans measured once regardless of the number of lanes or roadbeds.



**Project Number:** RMC 6440-15-001**Sheet 3M****County:** Palo Pinto**Control:** 6440-15-001**Highway:** IH 20, ETC.

**Item 731.9. Payment.** Broadcast Application will be paid by the Acre. Acres will be calculated using the calibrated Gallons Per Acres (GPA) of the equipment.

**Item 734. Litter Removal.**

Prior to Bidding: Contractor is responsible for inspecting the roadways within the limits of this contract where work will be performed and more specifically to identify areas that require handwork such as but not limited to landscape areas, weep holes, and attenuators/TRACC systems.

The required production rate for litter removal is 200 acres per day. A fraction of a day will be rounded to the next whole number.

Prior to the start of the initial work, a schedule will be approved by the Department.

Begin removing Spot Litter within 1 hr. of each notification.

Measure the volume of litter removed from each tract, as directed.

Maintain a record of work performed. A record form will be in a neat, orderly, and presentable manner. The record will contain as a minimum:

- A. The start and ending date of each tract.
- B. Work Order Number
- C. Volume of litter removed.
- D. Number of contract personal and equipment.

Record will be submitted as directed.

Litter removal will be allowed before or after the mowing cycle.

If litter is removed before mowing operations, it will be done no more than 3 days prior to mowing operations. Pick up any litter remaining after mowing operations.

If litter is removed after mowing operations, it will be done no later than 2 days after mowing.

Only one cycle of litter will be paid per mowing cycle.

**Project Number:** RMC 6440-15-001**Sheet 3N****County:** Palo Pinto**Control:** 6440-15-001**Highway:** IH 20, ETC.**Item 6001. Portable Changeable Message Sign.**

Provide electronic portable changeable message sign unit(s) as directed.

If more than one (1) crew works on the same day, but in different locations, each crew will use portable changeable message signs and arrow panels.

Each sign will have the following eighteen (18) messages programmed in its permanent memory:

1. Ramp Closed Ahead
2. Use Other Routes
3. Right Lane Closed
4. Left Lane Closed
5. Closed Ahead
6. Two Lane
7. Detour Ahead
8. Thru Traffic
9. Be Prepared To Stop
10. Merging Traffic
11. Expect 15 Minute Delay
12. Max Speed \*\*MPH
13. Merge Right
14. Merge Left
15. No Exit Next \*\* Miles
16. Various Lanes Closed
17. Two Left Lanes Closed
18. Two right Lanes Closed

**Project Number:** RMC 6440-15-001

**Sheet 3O**

**County:** Palo Pinto

**Control:** 6440-15-001

**Highway:** IH 20, ETC.

**Item 6185. Truck Mounted Attenuators (TMA).**

The total number of truck mounted attenuators (TMA) required when utilizing the traffic control standards are shown in the tables below.

TCP 1 Series	Scenario	Required TMA
(1-1)-18		1
(1-2)-18		1
(1-3)-18	A	1
	B	2
(1-4)-18		1
(1-5)-18		1

TCP 2 Series	Scenario	Required TMA
(2-1)-18		1
(2-2)-18		1
(2-3)-18	A	1
	B	2
(2-4)-18		1
(2-6)-18		1

TCP 3 Series	Scenario	Required TMA
(3-1)-13	All	2
(3-2)-13	All	3
(3-5)-18	All	1

TCP 5 Series	Scenario	Required TMA
(5-1)-18	A	1
	B	2

TCP 6 Series	Scenario	Required TMA
(6-1)12	A	1
	B	2
(6-2)-12	All	1
(6-3)-12	All	1
(6-4)-12	A	1
	B	2
(6-8)-14	All	1
(6-9)14	All	1

Shadow vehicles equipped for truck mounted attenuators (TMA) for mobile and stationary operations must be available for use at any time as determined by the Engineer.

**Project Number:** RMC 6440-15-001

**Sheet 3P**

**County:** Palo Pinto

**Control:** 6440-15-001

**Highway:** IH 20, ETC.

The Contractor will be responsible for determining if one or more of these operations will be ongoing at the same time to determine the total number of TMA needed for the project for those times per plan requirements. Additional TMAs used that are not specified in the plans in which the Contractor expects compensation will require prior approval from the Engineer.



# Estimate & Quantity Sheet

CONTROLLING PROJECT ID 6440-15-001

DISTRICT Fort Worth  
HIGHWAY IH0020

COUNTY Palo Pinto

CONTROL SECTION JOB				6440-15-001		TOTAL EST.	TOTAL FINAL
PROJECT ID				A00195571			
COUNTY				Palo Pinto			
HIGHWAY				IH0020			
ALT	BID CODE	DESCRIPTION	UNIT	EST.	FINAL		
	500-6033	MOBILIZATION (CALLOUT)	EA	14.000		14.000	
	730-6001	STRIP MOWING	AC	1,700.000		1,700.000	
	730-6002	FULL - WIDTH MOWING	AC	20,424.000		20,424.000	
	730-6003	SPOT MOWING	AC	400.000		400.000	
	731-6007	PAVEMENT EDGES, STRUCTURES & FIXTURES	MI	1,669.200		1,669.200	
	731-6011	BROADCAST APPLICATION	AC	8,162.000		8,162.000	
	734-6001	LITTER REMOVAL	AC	20,424.000		20,424.000	
	734-6003	LITTER REMOVAL (SPOT)	AC	400.000		400.000	
	6185-6005	TMA (MOBILE OPERATION)	DAY	130.000		130.000	

DISTRICT	COUNTY	CCSJ	SHEET
Fort Worth	Palo Pinto	6440-15-001	

HIGHWAYS TO BE COVERED BY THIS PROPOSAL PALO PINTO CO. SECTION 09

Tract	County	Highway	Limits	Reference Marker	Centerline Miles	Item 730 6007 Roadside Mowing			Item 731 Litter Removal			Item 731 Herbicide					* Pavement structures &		
						Number of Full-Width Mowing	Number of Acres per Full-Width Mowing	Total Number of Full-Width Mowing Acres	Number of Litter Removal Cycles	Number of Acres Per Tract	Total Number of Litter Removal Acres	Centerline Miles	Mowing Acres	Number of Herbicide Cycles	Item 731 6011 Number of Acres per Cycle	Item 731 6011 Number of Herbicide		Item 731 6007 Number of miles per	Item 731 6007 Total Number of
R-1	Erath (073)	IH 20	Fr: Eastland County Line, east To: Palo Pinto County Line	364 370	5.90	3	185	585	3	185	585	5.90	185	2	117.00	234.00	5.90	11.80	47.20
R-2	Palo Pinto (182)	IH 20	Fr: Erath County Line, east To: Parker County Line	370 391	20.80	3	867	2,601	3	867	2,601	20.80	867	2	520.20	1,040.40	20.80	41.60	166.40
R-3	Palo Pinto (182)	US 180	Fr: Stephens County Line, east To: Parker County Line	498 532	33.30	3	243	729	3	243	729	33.30	243	2	145.80	291.60	33.30	66.60	66.60
R-4	Palo Pinto (182)	US 281	Fr: Jack County Line, south To: Erath County Line	268 304	35.20	3	236	708	3	236	708	35.20	236	2	141.60	283.20	35.20	70.40	70.40
R-5	Palo Pinto (182)	SH 16	Fr: Young County Line, south To: US 180	266 290	24.20	3	218	654	3	218	654	24.20	218	2	130.80	261.60	24.20	48.40	48.40
R-6	Palo Pinto (182)	SH 16	Fr: US 180, south To: Eastland County Line	294 310	14.70	3	99	297	3	99	297	14.70	99	2	59.40	118.80	14.70	29.40	29.40
R-7	Palo Pinto (182)	SH 108	Fr: SH 16, east & south To: Erath County Line	488 500	7.10	3	45	135	3	45	135	7.10	45	2	27.00	54.00	7.10	14.20	14.20
R-8	Palo Pinto (182)	SH 193	Fr: SH 108, east To: IH 20	494 501	6.50	3	54	162	3	54	162	6.50	54	2	32.40	64.80	6.50	13.00	13.00
R-9	Palo Pinto (182)	SH 254	Fr: SH 16, east To: US 281	502 521	18.40	3	138	414	3	138	414	18.40	138	2	82.80	165.60	18.40	36.80	36.80
R-10	Palo Pinto (182)	SH 337	Fr: SH 16, south To: US 180	492 514	21.10	3	194	582	3	194	582	21.10	194	2	116.40	232.80	21.10	42.20	42.20
R-11	Palo Pinto (182)	LP 397	Fr: FM 4, east To: SH 254	402 403	0.80	3	3	9	3	3	9								
R-12	Palo Pinto (182)	LP 533	Fr: SH 337, east To: SH 16	492 493	1.10	3	9	27	3	9	27	1.10	9	2	5.40	10.80	1.10	2.20	2.20
R-13	Palo Pinto (182)	PR 36	Fr: Entrance to Camp Grady, east To: SH 16	486 492	5.60	3	16	48	3	16	48	5.60	16	2	9.60	19.20	5.60	11.20	11.20
R-14	Palo Pinto (182)	FM 4	Fr: Jack County Line, south To: Hood County Line	254 302	44.50	3	311	933	3	311	933	44.50	311	2	186.60	373.20	44.50	89.00	89.00
R-15	Palo Pinto (182)	FM 52	Fr: SH 254, north & east To: Parker County Line	506 514	7.90	3	44	132	3	44	132	7.90	44	2	26.40	52.80	7.90	15.80	15.80
R-16	Palo Pinto (182)	FM 129	Fr: FM 4, east To: US 281	504 515	10.20	3	81	243	3	81	243	10.20	81	2	48.60	97.20	10.20	20.40	20.40
R-17	Palo Pinto (182)	FM 207	Fr: Stephens County Line, east To: SH 16	494 500	5.40	3	50	150	3	50	150	5.40	50	2	30.00	60.00	5.40	10.80	10.80
R-18	Palo Pinto (182)	FM 919	Fr: US 180, south To: IH 20	272 288	15.70	3	116	348	3	116	348	15.70	116	2	69.60	139.20	15.70	31.40	31.40
R-19	Palo Pinto (182)	FM 1885	Fr: US 281, east To: Parker County Line	512 513	0.90	3	10	30	3	10	30	0.90	10	2	6.00	12.00	0.90	1.80	1.80
R-20	Palo Pinto (182)	FM 2201	Fr: FM 4, east To: US 281	504 511	6.40	3	36	108	3	36	108	6.40	36	2	21.60	43.20	6.40	12.80	12.80
R-21	Palo Pinto (182)	FM 2256	Fr: End of pavement, north To: US 281	268 274	5.10	3	49	147	3	49	147	5.10	49	2	29.40	58.80	5.10	10.20	10.20
R-22	Palo Pinto (182)	FM 2270	Fr: End of State Maintenance, east To: US 281	512 513	0.50	3	5	15	3	5	15	0.50	5	2	3.00	6.00	0.50	1.00	1.00
R-23	Palo Pinto (182)	FM 2353	Fr: SH 16, south To: SH 16	256 262	5.90	3	54	162	3	54	162	5.90	54	2	32.40	64.80	5.90	11.80	11.80
R-24	Palo Pinto (182)	FM 2372	Fr: End of pavement, east To: SH 16	484 488	4.20	3	33	99	3	33	99	4.20	33	2	19.80	39.60	4.20	8.40	8.40
R-25	Palo Pinto (182)	FM 2692	Fr: FM 919, east To: End of pavement	494 502	8.10	3	72	216	3	72	216	8.10	72	2	43.20	86.40	8.10	16.20	16.20
R-26	Palo Pinto (182)	FM 2803	Fr: FM 4, south To: Erath County Line	506 508	1.00	3	8	24	3	8	24	1.00	8	2	4.80	9.60	1.00	2.00	2.00
R-27	Palo Pinto (182)	FM 2951	Fr: End of pavement at Sandy Beach To: PR 36	486 490	3.70	3	15	45	3	15	45	3.70	15	2	9.00	18.00	3.70	7.40	7.40
R-28	Palo Pinto (182)	FM 3137	Fr: FM 919, east To: FM 4	496 504	7.40	3	64	192	3	64	192	7.40	64	2	38.40	76.80	7.40	14.80	14.80
R-29	Palo Pinto (182)	FM 1195	Fr: US 180, south & west To: US 281	266 272	6.00	3	55	165	3	55	165	6.00	55	2	33.00	66.00	6.00	12.00	12.00
R-30	Palo Pinto (182)	FM 1821	Fr: US 281, east, south & east To: FM 1195	264 270	5.60	3	47	141	3	47	141	5.60	47	2	28.20	56.40	5.60	11.20	11.20
R-31	Palo Pinto (182)	FM 3027	Fr: End of pavement, southeast To: FM 1821	506 511	4.50	3	35	105	3	35	105	4.50	35	2	21.00	42.00	4.50	9.00	9.00
R-32	Palo Pinto (182)	FM 3028	Fr: FM 1195, east To: Parker County Line	514 515	0.30	3	2	6	3	2	6	0.30	2	2	1.20	2.40	0.30	0.60	0.60
<b>GRAND TOTAL</b>					<b>338.00</b>		<b>3404.00</b>	<b>10212.00</b>		<b>3404.00</b>	<b>10212.00</b>	<b>331.30</b>	<b>3206.00</b>		<b>2,041</b>	<b>4,081</b>	<b>337.20</b>	<b>674.40</b>	<b>834.60</b>

\* FOR INFORMATIONAL PURPOSES\*

R=Rural (3 Full-Width Mowing Cycles per year)

THIS IS A CENTER LINE MILE CONTRACT FOR EDGE SPRAY



**LIMIT SHEET**

REVISIONS	FED. RD. DIV. NO.	STATE PROJECT NO.		SHEET NO.
	6	RMC	644015001	5
	STATE	DISTRICT	COUNTY	
	TEXAS	FTW	PALO PINTO	
CONTROL	SECTION	JOB	HIGHWAY NO.	
	6440	15	001	IH 20, ETC.

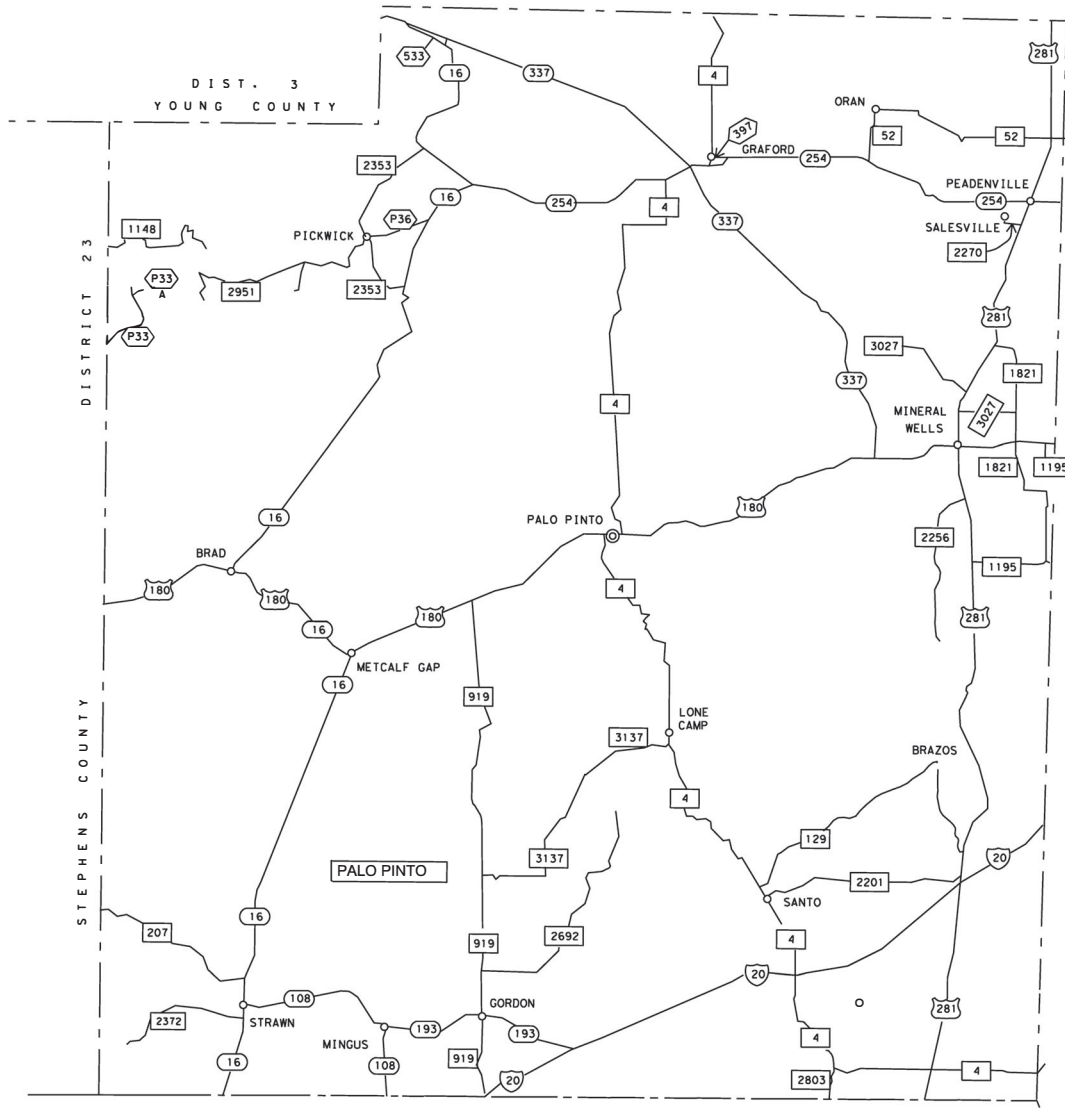

# PALO PINTO COUNTY

©2023 by Texas Department of Transportation;  
all rights reserved



## PROJECT LOCATION MAP

<b>C.O.</b>	FED. RD. DIV. NO. <b>6</b>	STATE PROJECT NO. <b>RMC 644015001</b>	SHEET NO. <b>6</b>
<b>REVISIONS</b>	STATE	DISTRICT <b>FTW</b>	COUNTY <b>PALO PINTO</b>
	CONTROL	SECTION <b>15</b>	JOB <b>001</b>
			HIGHWAY NO. <b>IH 20, ETC.</b>

DISCLAIMER: This standard is governed by the "Texas Engineering Practice Act". No warranty of any kind is made by TxDOT for any purpose whatsoever. TxDOT assumes no responsibility for the conversion of this standard to other formats or for incorrect results or damages resulting from its use.

DATE: FILE:

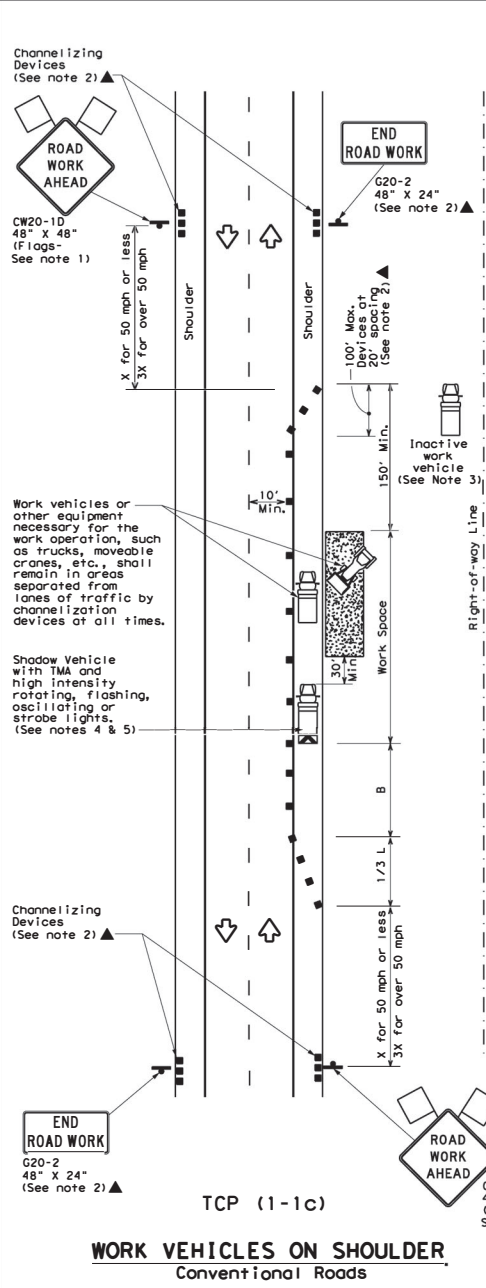
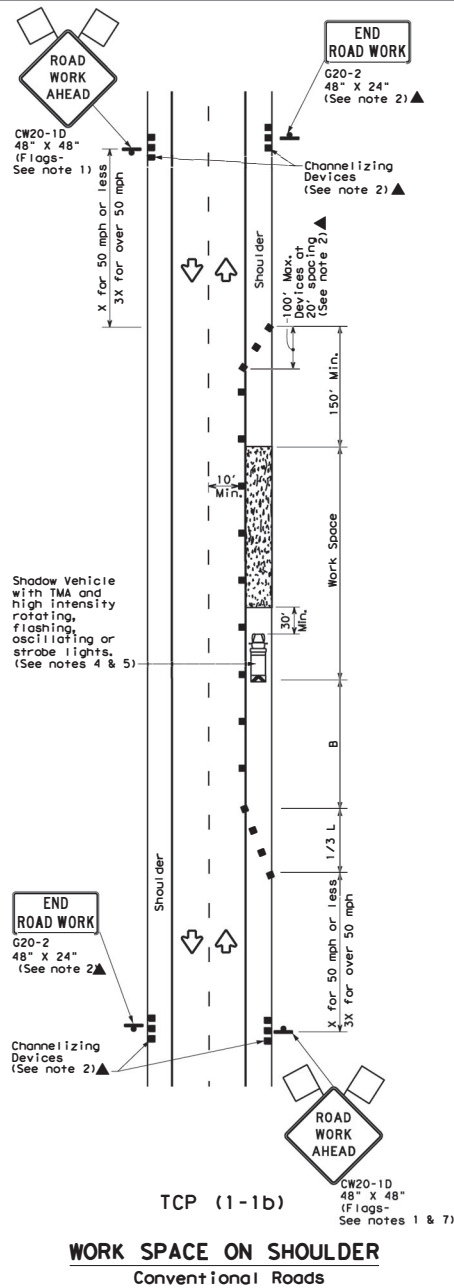
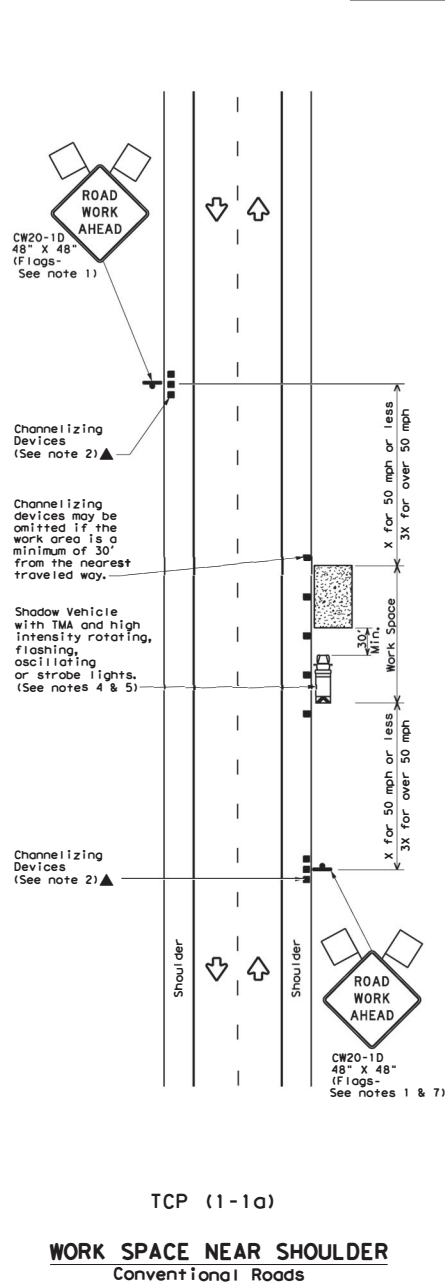

LEGEND			
	Type 3 Barricade		Channelizing Devices
	Heavy Work Vehicle		Truck Mounted Attenuator (TMA)
	Trailer Mounted Flashing Arrow Board		Portable Changeable Message Sign (PCMS)
	Sign		Traffic Flow
	Flag		Flagger

Posted Speed * L = WS 60	Formula	Minimum Desirable Taper Lengths * x %			Suggested Maximum Spacing of Channelizing Devices		Minimum Sign Spacing "x"	Suggested Longitudinal Buffer Space "B"
		10' Offset	11' Offset	12' Offset	On a Taper	On a Tangent		
30		150'	165'	180'	30'	60'	120'	90'
35		205'	225'	245'	35'	70'	160'	120'
40		265'	295'	320'	40'	80'	240'	155'
45		450'	495'	540'	45'	90'	320'	195'
50		500'	550'	600'	50'	100'	400'	240'
55		550'	605'	660'	55'	110'	500'	295'
60		600'	660'	720'	60'	120'	600'	350'
65		650'	715'	780'	65'	130'	700'	410'
70		700'	770'	840'	70'	140'	800'	475'
75		750'	825'	900'	75'	150'	900'	540'

\* Conventional Roads Only  
\*\* Taper Lengths have been rounded off.  
L=Length of Taper(FT) W=Width of Offset(FT) S=Posted Speed(IMPH)

TYPICAL USAGE				
MOBILE	SHORT DURATION	SHORT TERM STATIONARY	INTERMEDIATE TERM STATIONARY	LONG TERM STATIONARY
	✓	✓		

- GENERAL NOTES**
- Flags attached to signs where shown are REQUIRED.
  - All traffic control devices illustrated are REQUIRED, except those denoted with the triangle symbol may be omitted when stated elsewhere in the plans, or for routine maintenance work, when approved by the Engineer.
  - Inactive work vehicles or other equipment should be parked near the right-of-way line and not parked on the paved shoulder.
  - A Shadow Vehicle with a TMA should be used anytime it can be positioned 30 to 100 feet in advance of the area of crew exposure without adversely affecting the performance or quality of the work. If workers are no longer present but road or work conditions require the traffic control to remain in place, Type 3 Barricades or other channelizing devices may be substituted for the Shadow Vehicle and TMA.
  - Additional Shadow Vehicles with TMAs may be positioned off the paved surface, next to those shown in order to protect wider work spaces.
  - See TCP(5-1) for shoulder work on divided highways, expressways and freeways.
  - CW21-5 "SHOULDER WORK" signs may be used in place of CW20-1D "ROAD WORK AHEAD" signs for shoulder work on conventional roadways.

Texas Department of Transportation

**TRAFFIC CONTROL PLAN**  
**CONVENTIONAL ROAD**  
**SHOULDER WORK**

**TCP (1-1) - 18**

FILE: tcp1-1-18.dgn	DATE: 12/18/95	BY: TxDOT	CHK: TxDOT	DATE: TxDOT	CHK: TxDOT
REVISIONS	NO.	DATE	BY	REASON	
2-94	4-98				
8-95	2-12				
1-97	2-18				

PROJECT: PALO PINTO

DISCLAIMER: This standard is governed by the "Texas Engineering Practice Act". No warranty of any kind is made by TxDOT for any purpose whatsoever. TxDOT assumes no responsibility for the conversion of this standard to other formats or for incorrect results or damages resulting from its use.

DATE: FILE:

Warning Sign Sequence in Opposite Direction Same as Below

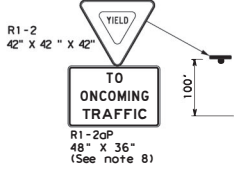

Channelizing devices separate work space from traveled way

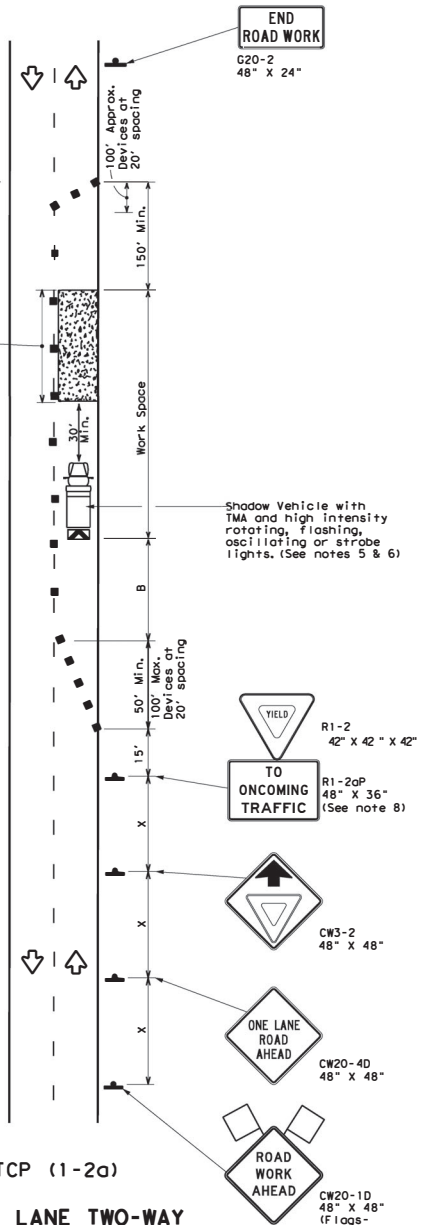

**TCP (1-2a)**  
**ONE LANE TWO-WAY CONTROL WITH YIELD SIGNS**  
 (Less than 2000 ADT - See note 7)

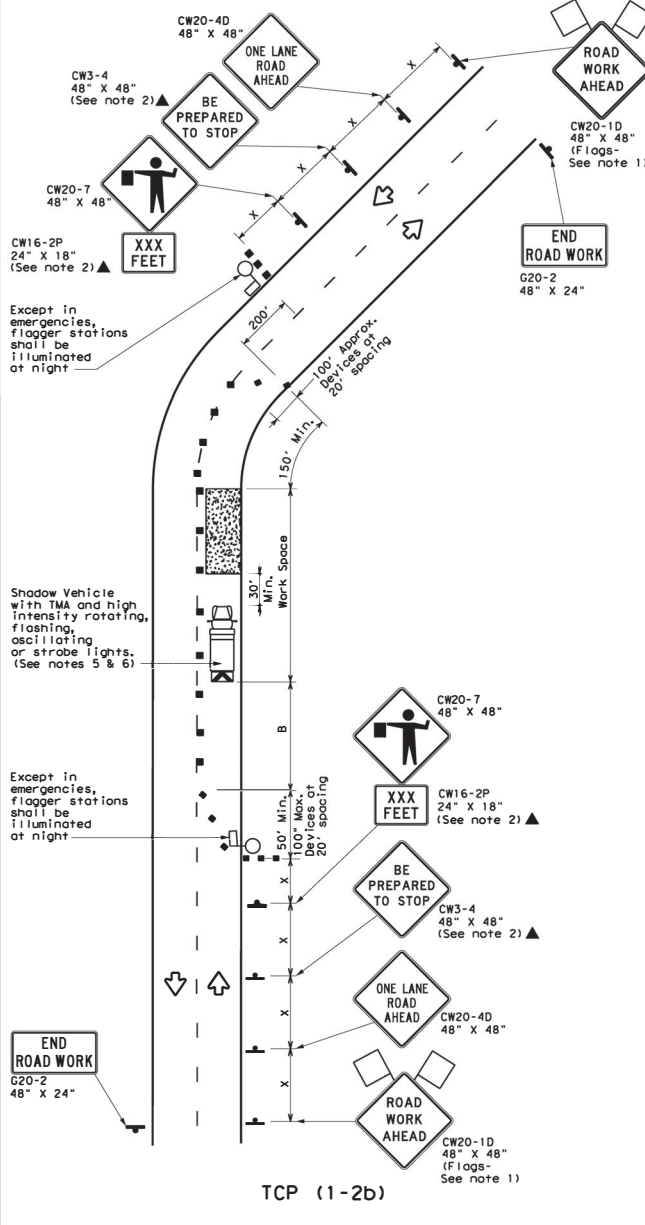

**TCP (1-2b)**  
**ONE LANE TWO-WAY CONTROL WITH FLAGGERS**

LEGEND			
	Type 3 Barricade		Channelizing Devices
	Heavy Work Vehicle		Truck Mounted Attenuator (TMA)
	Trailer Mounted Flashing Arrow Board		Portable Changeable Message Sign (PCMS)
	Sign		Traffic Flow
	Flag		Flagger

Posted Speed *	Formula	Minimum Desirable Taper Lengths **			Suggested Maximum Spacing of Channelizing Devices		Minimum Sign Spacing "X"	Suggested Longitudinal Buffer Space "B"	Stopping Distance
		10' Offset	11' Offset	12' Offset	On a Taper	On a Tangent			
30	L = WS / 60	150'	165'	180'	30'	60'	120'	90'	200'
35		205'	225'	245'	35'	70'	160'	120'	250'
40		265'	295'	320'	40'	80'	240'	155'	305'
45	L = WS	450'	495'	540'	45'	90'	320'	195'	360'
50		500'	550'	600'	50'	100'	400'	240'	425'
55		550'	605'	660'	55'	110'	500'	295'	495'
60		600'	660'	720'	60'	120'	600'	350'	570'
65		650'	715'	780'	65'	130'	700'	410'	645'
70	700'	770'	840'	70'	140'	800'	475'	730'	
75	750'	825'	900'	75'	150'	900'	540'	820'	

\* Conventional Roads Only  
 \*\* Taper lengths have been rounded off.  
 L=Length of Taper (FT) W=Width of Offset (FT) S=Posted Speed (MPH)

TYPICAL USAGE				
MOBILE	SHORT DURATION	SHORT TERM STATIONARY	INTERMEDIATE TERM STATIONARY	LONG TERM STATIONARY
	✓		✓	

- GENERAL NOTES**
- Flags attached to signs where shown are REQUIRED.
  - All traffic control devices illustrated are REQUIRED, except those denoted with the triangle symbol may be omitted when stated elsewhere in the plans, or for routine maintenance work, when approved by the Engineer.
  - The CW3-4 "BE PREPARED TO STOP" sign may be installed after the CW20-4D "ONE LANE ROAD AHEAD" sign, but proper sign spacing shall be maintained.
  - Sign spacing may be increased on an additional CW20-1D "ROAD WORK AHEAD" sign may be used if advance warning ahead of the flagger or R1-2 "YIELD" sign is less than 1500 feet.
  - A Shadow Vehicle with a TMA should be used anytime it can be positioned 30 to 100 feet in advance of the area of crew exposure without adversely affecting the performance or quality of the work. If workers are no longer present but road or work conditions require the traffic control to remain in place, Type 3 Barricades or other channelizing devices may be substituted for the Shadow Vehicle and TMA.
  - Additional Shadow Vehicles with TMAs may be positioned off the paved surface, next to those shown in order to protect wider work spaces.
- TCP (1-2a)**
- R1-2 "YIELD" sign traffic control may be used on projects with approaches that have adequate sight distance. For projects in urban areas, work spaces should be no longer than one half city block. In rural areas on roadways with less than 2000 ADT, work spaces should be no longer than 400 feet.
  - R1-2 "YIELD" sign with R1-2aP "TO ONCOMING TRAFFIC" plaque shall be placed on a support at a 7 foot minimum mounting height.
- TCP (1-2b)**
- Flaggers should use two-way radios or other methods of communication to control traffic.
  - Length of work space should be based on the ability of flaggers to communicate.
  - If the work space is located near a horizontal or vertical curve, the buffer distances should be increased in order to maintain adequate stopping sight distance to the flagger and a queue of stopped vehicles (see table above).
  - Channelizing devices on the center-line may be omitted when a pilot car is leading traffic and approved by the Engineer.
  - Flaggers should use 24" STOP/SLOW paddles to control traffic. Flags should be limited to emergency situations.

Texas Department of Transportation  
Traffic Operations Division Standard

## TRAFFIC CONTROL PLAN ONE-LANE TWO-WAY TRAFFIC CONTROL

### TCP (1-2) - 18

FILE: tcp1-2-18.dgn	DATE: TXDOT	DATE: TXDOT	DATE: TXDOT	DATE: TXDOT
© TXDOT December 1985	CONTRACT	SECTION	JOB	HIGHWAY
4-90 4-98	8440	15	001	TH 20 ETC.
2-94 2-12	0157		COUNTY	SHEET NO.
1-97 2-18	02		PAID PRINT	0

DISCLAIMER: This standard is governed by the "Texas Engineering Practice Act". No warranty of any kind is made by TxDOT for any purpose whatsoever. TxDOT assumes no responsibility for the conversion of this standard to other formats or for incorrect results or damages resulting from its use.

DATE: FILE:

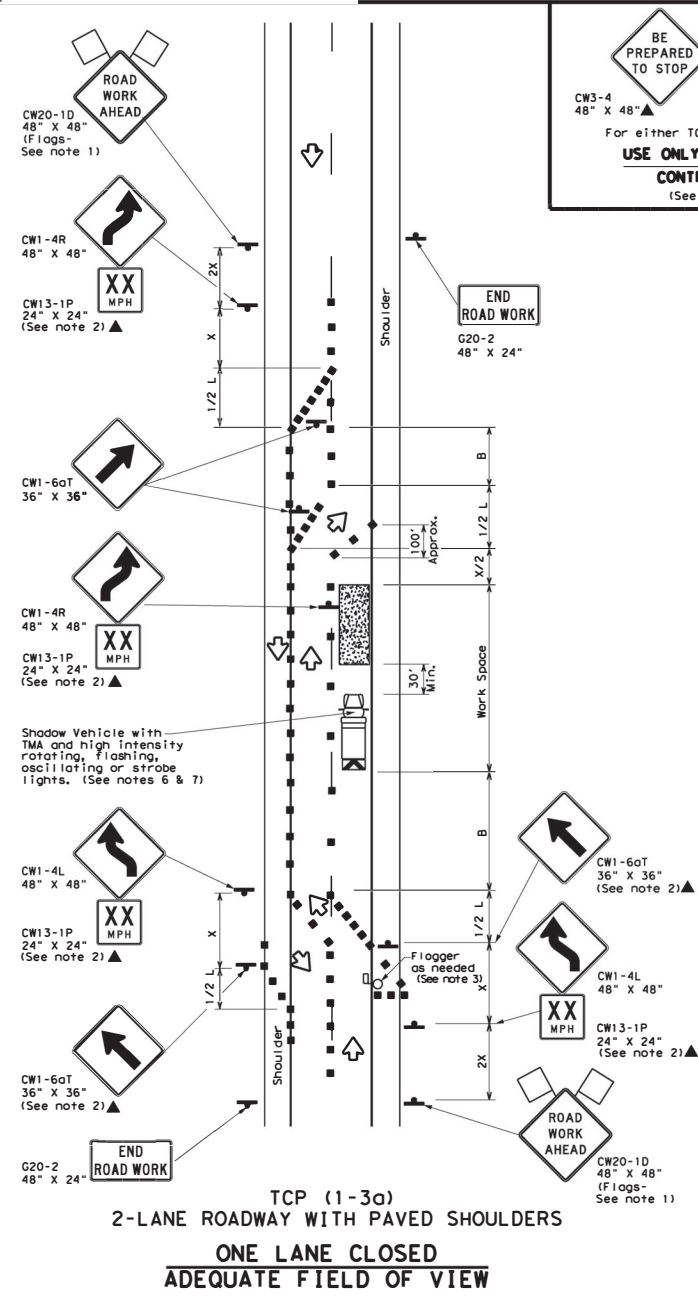

**BE PREPARED TO STOP**

CW3-4 48" X 48" (Flags - See note 1) CW20-7 48" X 48" (Flags - See note 1)

For either TCP (1-3a) or TCP (1-3b)

**USE ONLY WHEN FLAGGERS CONTROL TRAFFIC**

(See Notes 2 & 3)

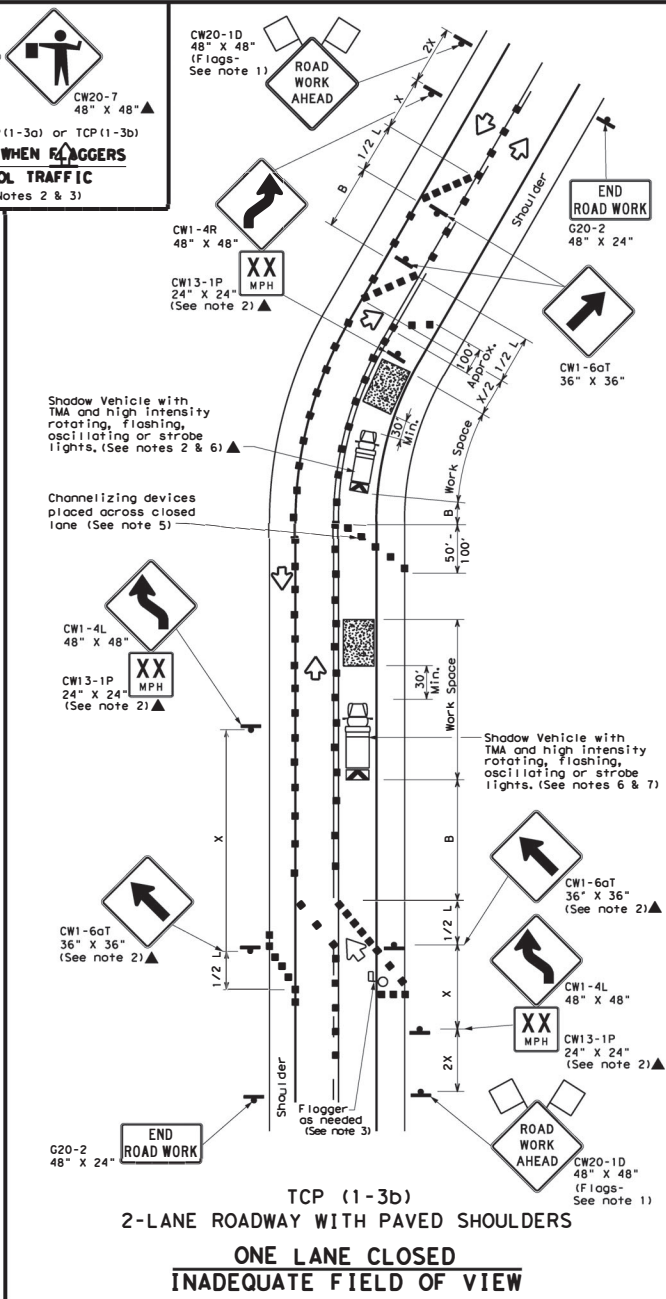

**LEGEND**

	Type 3 Barricade		Channelizing Devices
	Heavy Work Vehicle		Truck Mounted Attenuator (TMA)
	Trailer Mounted Flashing Arrow Board		Portable Changeable Message Sign (PCMS)
	Sign		Traffic Flow
	Flag		Flagger

Posted Speed * k	Formula	Minimum Desirable Taper Lengths **			Suggested Maximum Spacing of Channelizing Devices		Minimum Sign Spacing Distance	Suggested Longitudinal Buffer Space "B"
		10' Offset	11' Offset	12' Offset	On a Taper	On a Tangent		
30	L = WS <sup>2</sup> / 60	150'	165'	180'	30'	60'	120'	90'
35		205'	225'	245'	35'	70'	160'	120'
40	L = WS	265'	295'	320'	40'	80'	240'	155'
45		450'	495'	540'	45'	90'	320'	195'
50	L = WS	500'	550'	600'	50'	100'	400'	240'
55		550'	605'	660'	55'	110'	500'	295'
60	L = WS	600'	660'	720'	60'	120'	600'	350'
65		650'	715'	780'	65'	130'	700'	410'
70	L = WS	700'	770'	840'	70'	140'	800'	475'
75		750'	825'	900'	75'	150'	900'	540'

\* Conventional Roads Only  
\*\* Taper lengths have been rounded off.  
L=Length of Taper (FT) W=Width of Offset(FT) S=Posted Speed(MPH)

**TYPICAL USAGE**

MOB I/E	SHORT DURATION	SHORT TERM STATIONARY	INTERMEDIATE TERM STATIONARY	LONG TERM STATIONARY
	✓	✓		

- GENERAL NOTES**
- Flags attached to signs where shown are REQUIRED.
  - All traffic control devices illustrated are REQUIRED, except those denoted with the triangle symbol may be omitted when stated elsewhere in the plans, or for routine maintenance work, when approved by the Engineer.
  - Flagger control should NOT be used unless roadway conditions or heavy traffic volume require additional emphasis to safely control traffic. Additional flaggers may be positioned in advance of traffic queues to alert traffic to reduce speed.
  - DO NOT PASS, PASS WITH CARE and construction regulatory speed zone signs may be installed downstream of the ROAD WORK AHEAD signs.
  - When the work zone is made up of several work spaces, channelizing devices should be placed laterally across the closed lane to re-emphasize closure. Laterally placed channelizing devices should be repeated every 500 to 1000 feet in urban areas and every 1/4 to 1/2 mile in rural areas.
  - A Shadow Vehicle with a TMA should be used anytime it can be positioned 30 to 100 feet in advance of the area of crew exposure without adversely affecting the performance or quality of the work. If workers are no longer present but road or work conditions require the traffic control to remain in place, Type 3 Barricades or other channelizing devices may be substituted for the Shadow Vehicle and TMA.
  - Additional Shadow Vehicles with TMAs may be positioned off the paved surface, next to those shown in order to protect wider work spaces.
  - Where traffic is directed over a yellow centerline, channelizing devices which separate two-way traffic should be spaced on tapers at 20', or 15' if posted speed are 35 mph or slower, and for tangent sections, at 1/2S where S is the speed in mph. This tighter device spacing is intended for the area of conflicting markings not the entire work zone.

**Texas Department of Transportation** Traffic Operations Division

**TRAFFIC CONTROL PLAN**  
**TRAFFIC SHIFTS ON**  
**TWO LANE ROADS**  
**TCP (1-3) - 18**

FILE: tcp1-3-18.dgn	DATE/TIME: 08/15/98	CONTRACT: 001	SECTION: 001	JOB: 001	HIGHWAY: 15
REVISIONS:	DATE:	BY:	DESCRIPTION:	DATE:	BY:
2-94 4-98	8-95 2-12	1-97 2-18			



DISCLAIMER: This standard is governed by the "Texas Engineering Practice Act". No warranty of any kind is made by TxDOT for any purpose whatsoever. TxDOT assumes no responsibility for the conversion of this standard to other formats or for incorrect results or damages resulting from its use.

DATE: FILE:

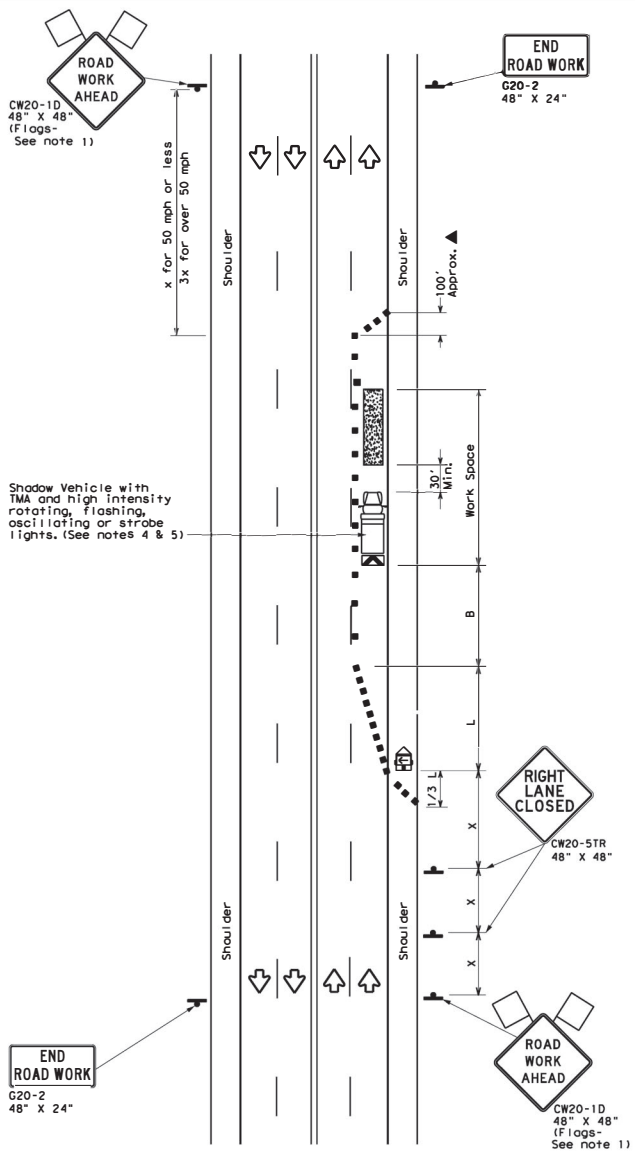

TCP (1-4a)

**ONE LANE CLOSED**

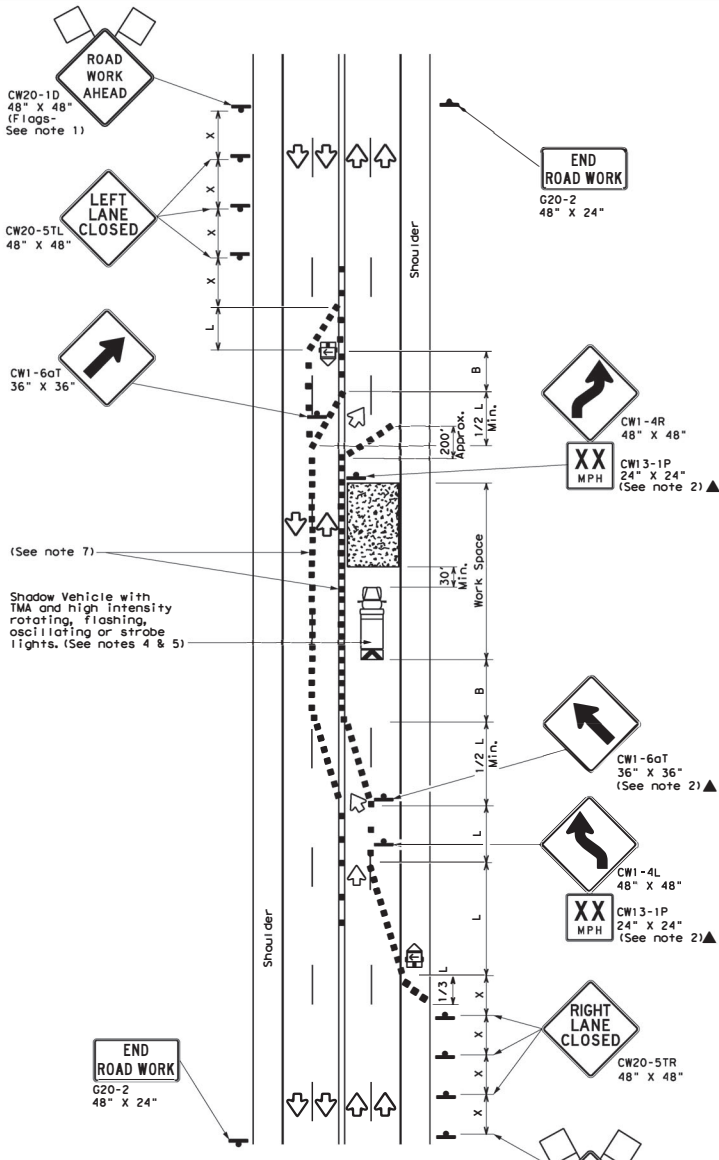

TCP (1-4b)

**TWO LANES CLOSED**

LEGEND			
	Type 3 Barricade		Channelizing Devices
	Heavy Work Vehicle		Truck Mounted Attenuator (TMA)
	Trailer Mounted Flashing Arrow Board		Portable Changeable Message Sign (PCMS)
	Sign		Traffic Flow
	Flag		Flagger

Posted Speed * *	Formula	Minimum Destructible Taper Lengths **			Suggested Maximum Spacing of Channelizing Devices		Minimum Sign Spacing "X" Distance	Suggested Longitudinal Buffer Space "B"
		10' Offset	11' Offset	12' Offset	On a Taper	On a Tangent		
30	L = WS <sup>2</sup> / 60	150'	165'	180'	30'	60'	120'	90'
35		205'	225'	245'	35'	70'	160'	120'
40	L = WS	265'	295'	320'	40'	80'	240'	155'
45		450'	495'	540'	45'	90'	320'	195'
50	L = WS	500'	550'	600'	50'	100'	400'	240'
55		550'	605'	660'	55'	110'	500'	295'
60	L = WS	600'	660'	720'	60'	120'	600'	350'
65		650'	715'	780'	65'	130'	700'	410'
70	L = WS	700'	770'	840'	70'	140'	800'	475'
75		750'	825'	900'	75'	150'	900'	540'

\* Conventional Roads Only  
\*\* Taper lengths have been rounded off.  
L=Length of Taper (FT) W=Width of Offset (FT) S=Posted Speed (MPH)

TYPICAL USAGE				
MOBILE	SHORT DURATION	SHORT TERM STATIONARY	INTERMEDIATE TERM STATIONARY	LONG TERM STATIONARY
	✓	✓		

- GENERAL NOTES**
- Flags attached to signs where shown are REQUIRED.
  - All traffic control devices illustrated are REQUIRED, except those denoted with the triangle symbol may be omitted when stated elsewhere in the plans, or for routine maintenance work, when approved by the Engineer.
  - The CW20-1D "ROAD WORK AHEAD" sign may be repeated if the visibility of the work zone is less than 1500 feet.
  - A Shadow Vehicle with a TMA should be used anytime it can be positioned 30 to 100 feet in advance of the area of crew exposure without adversely affecting the performance or quality of the work. If workers are no longer present but road or work conditions require the traffic control to remain in place, Type 3 Barricades or other channelizing devices may be substituted for the Shadow Vehicle and TMA.
  - Additional Shadow Vehicles with TMAs may be positioned off the paved surface, next to those shown in order to protect wider work spaces.
- TCP (1-4a)**
- If this TCP is used for a left lane closure, CW20-5TL "LEFT LANE CLOSED" signs shall be used and channelizing devices shall be placed on the centerline where needed to protect the work space from opposing traffic with the arrow panel placed in the closed lane near the end of the merging taper.
- TCP (1-4b)**
- Where traffic is directed over a yellow centerline, channelizing devices which separate two-way traffic should be spaced on tapers at 20' or 15' if posted speeds are 35 mph or slower, and for tangent sections, at 1/2S where S is the speed in mph. This tighter device spacing is intended for the areas of conflicting markings, not the entire work zone.

Traffic Operations Division Standard

## TRAFFIC CONTROL PLAN LANE CLOSURES ON MULTILANE CONVENTIONAL ROADS

### TCP (1-4) - 18

FILE: tcp1-4-18.dgn	DN: TXDOT	CK: TXDOT	DN: TXDOT	CK: TXDOT
© TxDOT December 1985	CONT	SECT	JOB	HIGHWAY
2-94 4-96	6440	15	001	1H 20 ETC.
8-95 2-12	DIST		COUNTY	SHEET NO.
1-97 2-18	02		PALO PINTO	10

[123]

DISCLAIMER: This standard is governed by the "Texas Engineering Practice Act". No warranty of any kind is made by TxDOT for any purpose whatsoever. TxDOT assumes no responsibility for the conversion of this standard to other formats or for incorrect results or damages resulting from its use.

DATE:  
FILE:

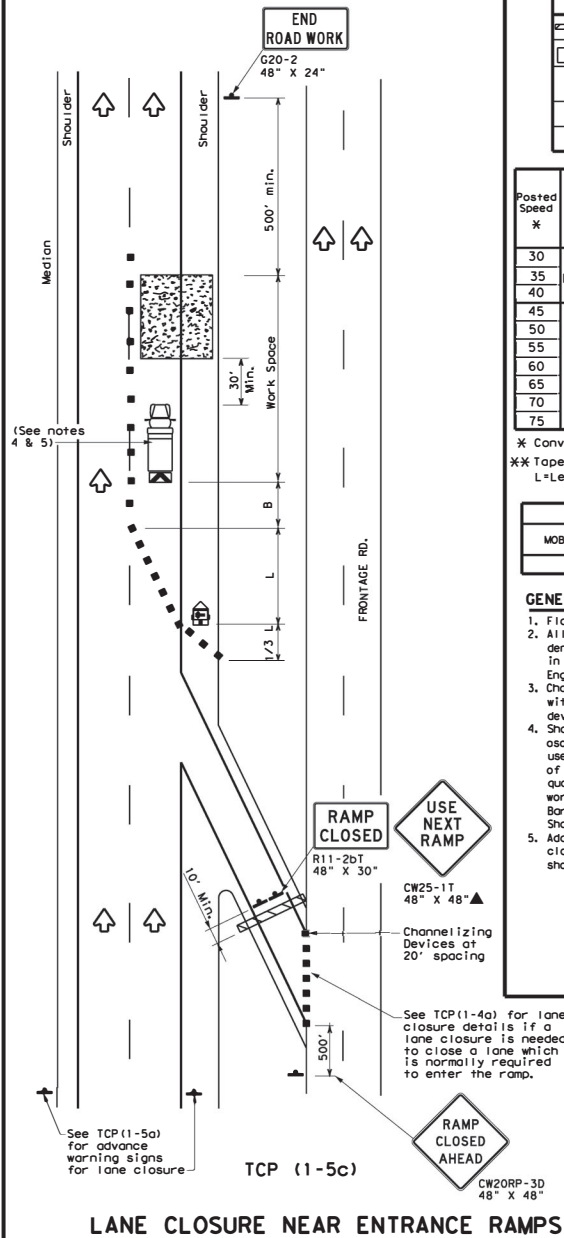
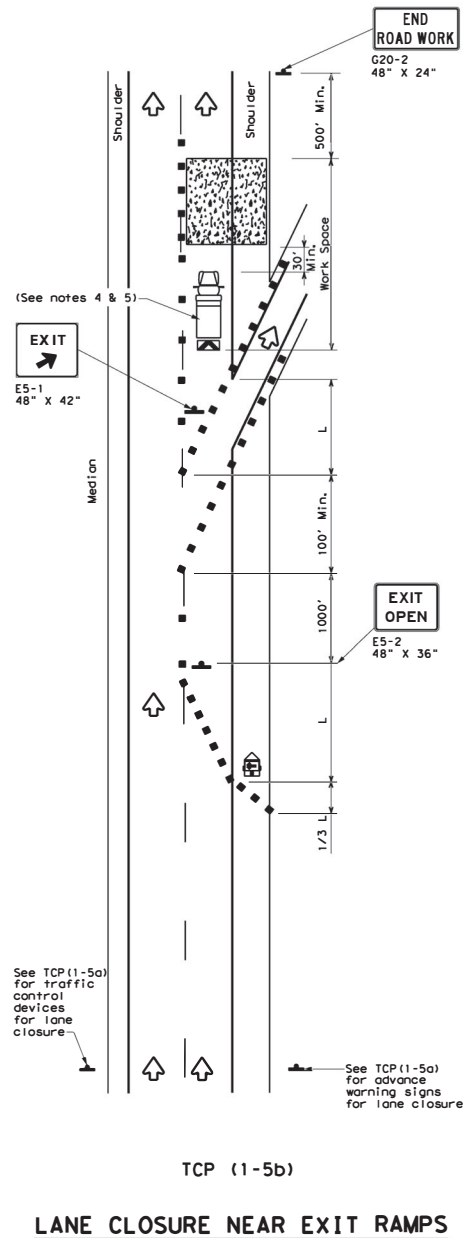
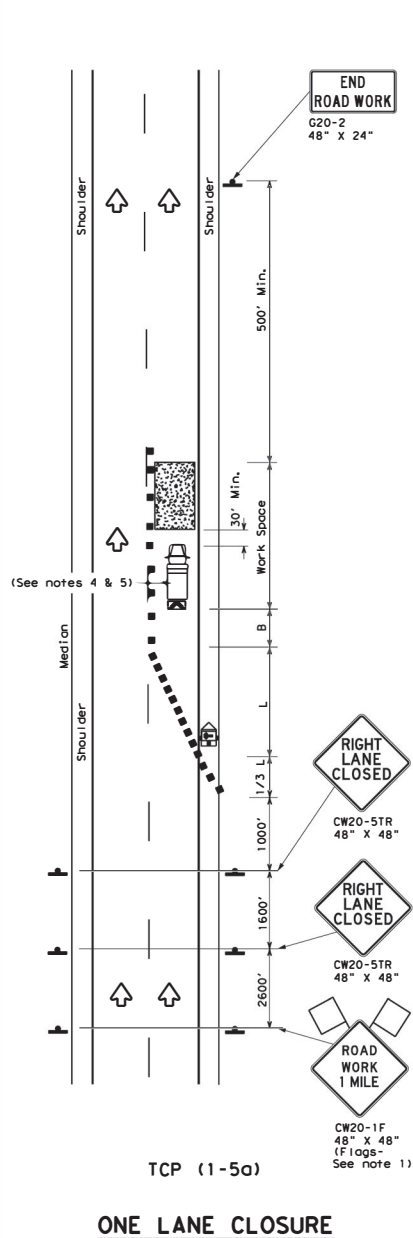

LEGEND			
	Type 3 Barricade		Channelizing Devices
	Heavy Work Vehicle		Truck Mounted Attenuator (TMA)
	Trailer Mounted Flashing Arrow Board		Portable Changeable Message Sign (PCMS)
	Sign		Traffic Flow
	Flag		Flagger

Posted Speed * L = WS 60	Formula	Minimum Desirable Taper Lengths * * %		Suggested Maximum Spacing of Channelizing Devices		Minimum Sign Spacing "x" Distance	Suggested Longitudinal Buffer Space "B"	
		10' Offset	11' 12' Offset	On a Taper	On a Tangent			
30	L = WS 60	150'	165'	180'	30'	60'	120'	90'
35		205'	225'	245'	35'	70'	160'	120'
40	L = WS	265'	295'	320'	40'	80'	240'	155'
45		450'	495'	540'	45'	90'	320'	195'
50	L = WS	500'	550'	600'	50'	100'	400'	240'
55		550'	605'	660'	55'	110'	500'	295'
60	L = WS	600'	660'	720'	60'	120'	600'	350'
65		650'	715'	780'	65'	130'	700'	410'
70	L = WS	700'	770'	840'	70'	140'	800'	475'
75		750'	825'	900'	75'	150'	900'	540'

\* Conventional Roads Only  
\*\* Taper lengths have been rounded off.  
L=Length of Taper (FT) W=Width of Offset (FT) S=Posted Speed (MPH)

MOBILE	TYPICAL USAGE			
	SHORT DURATION	SHORT TERM STATIONARY	INTERMEDIATE TERM STATIONARY	LONG TERM STATIONARY
		✓		

- GENERAL NOTES**
- Flags attached to signs where shown, are REQUIRED.
  - All traffic control devices illustrated are REQUIRED, except those denoted with the triangle symbol may be omitted when stated elsewhere in the plans, or for routine maintenance work, when approved by the Engineer.
  - Channelizing devices used to close lanes may be supplemented with the Chevron Alignment Sign placed on every other channelizing device. Chevrons may be attached to plastic drums as per BC Standards.
  - Shadow Vehicle with TMA and high intensity rotating, flashing, oscillating or strobe lights. A Shadow Vehicle with a TMA should be used anytime it can be positioned 30 to 100 feet in advance of the area of crew exposure without adversely affecting the performance or quality of the work. If workers are no longer present but road or work conditions require the traffic control to remain in place, Type 3 Barricades or other channelizing devices may be substituted for the Shadow Vehicle and TMA.
  - Additional Shadow Vehicles with TMAs may be positioned in each closed lane, on the shoulder or off the paved surface, next to those shown in order to protect a wider work space.



**TRAFFIC CONTROL PLAN  
LANE CLOSURES FOR  
DIVIDED HIGHWAYS**

**TCP (1-5) - 18**

FILE: tcp1-5-18.dgn	DATE: TXDOT	DATE: TXDOT	DATE: TXDOT	DATE: TXDOT
REVISIONS	CONT	SECT	JOB	HIGHWAY
2-18	6440	15	001	IH 20 ETC.
	01ST		COUNTY	SHEET NO.
	02		FALCO PINTO	11

DISCLAIMER: This standard is governed by the "Texas Engineering Practice Act". No warranty of any kind is made by TxDOT for any purpose whatsoever. TxDOT assumes no responsibility for the conversion of this standard to other formats or for incorrect results or damages resulting from its use.

DATE: FILE:

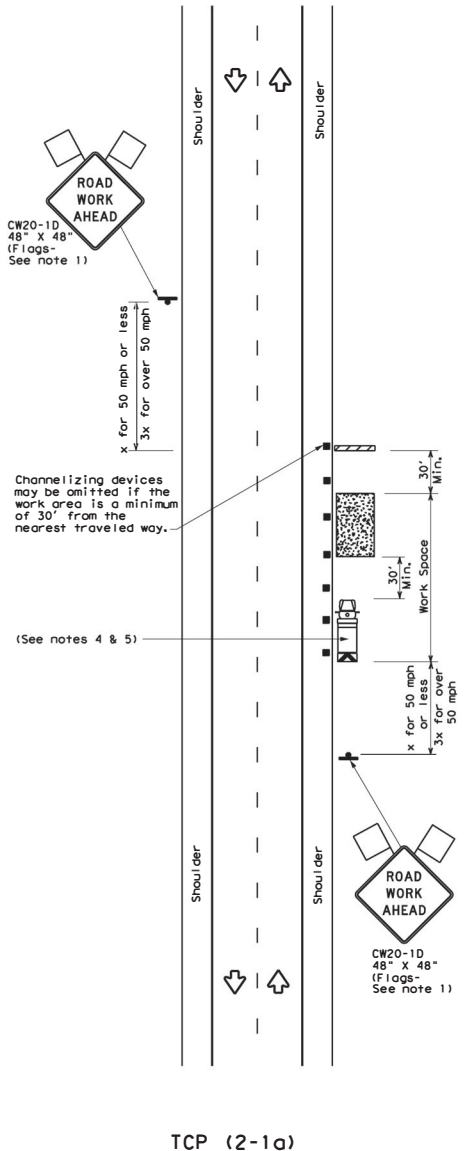

TCP (2-1a)

**WORK SPACE NEAR SHOULDER**  
Conventional Roads

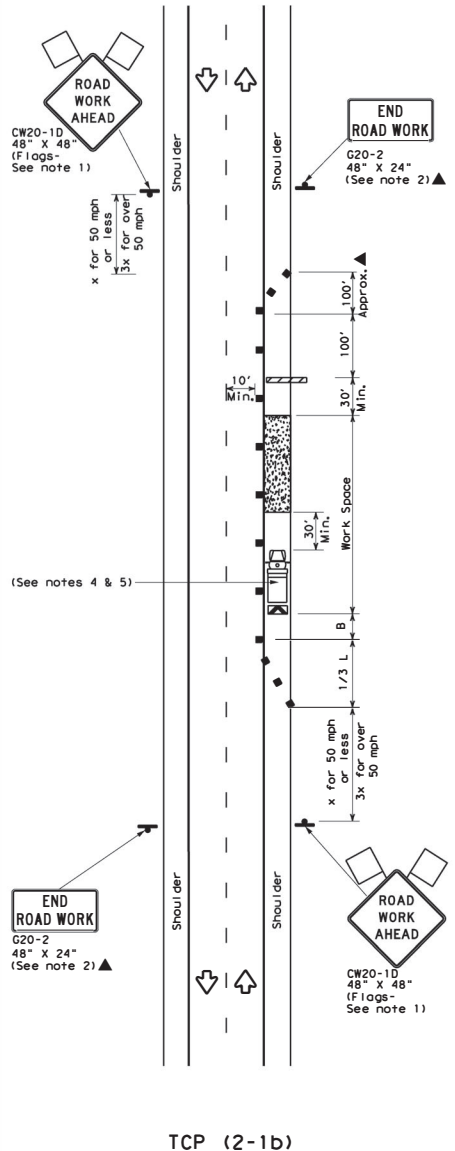

TCP (2-1b)

**WORK SPACE ON SHOULDER**  
Conventional Roads

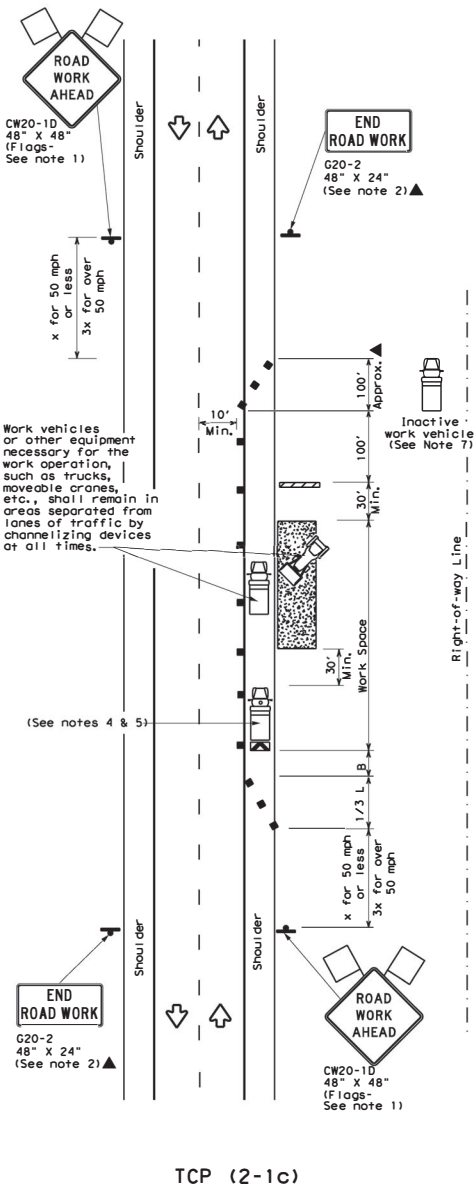

TCP (2-1c)

**WORK VEHICLES ON SHOULDER**  
Conventional Roads

LEGEND			
	Type 3 Barricade		Channelizing Devices
	Heavy Work Vehicle		Truck Mounted Attenuator (TMA)
	Trailer Mounted Flashing Arrow Board		Portable Changeable Message Sign (PCMS)
	Sign		Traffic Flow
	Flag		Flagger

Posted Speed * X	Formula	Minimum Desirable Taper Lengths * X			Suggested Maximum Spacing of Channelizing Devices		Minimum Sign Spacing "X" Distance	Suggested Longitudinal Buffer Space "B"
		10' Offset	11' Offset	12' Offset	On a Taper	On a Tangent		
30	$L = \frac{WS^2}{60}$	150'	165'	180'	30'	60'	120'	90'
35		205'	225'	245'	35'	70'	160'	120'
40		265'	295'	320'	40'	80'	240'	155'
45	$L = WS$	450'	495'	540'	45'	90'	320'	195'
50		500'	550'	600'	50'	100'	400'	240'
55		550'	605'	660'	55'	110'	500'	295'
60		600'	660'	720'	60'	120'	600'	350'
65		650'	715'	780'	65'	130'	700'	410'
70	700'	770'	840'	70'	140'	800'	475'	
75	750'	825'	900'	75'	150'	900'	540'	

\* Conventional Roads Only  
 \*\* Taper lengths have been rounded off.  
 L=Length of Taper (FT) W=Width of Offset (FT) S=Posted Speed (MPH)

TYPICAL USAGE				
MOBILE	SHORT DURATION	SHORT TERM STATIONARY	INTERMEDIATE TERM STATIONARY	LONG TERM STATIONARY
	✓	✓	✓	✓

- GENERAL NOTES**
- Flags attached to signs where shown, are REQUIRED.
  - All traffic control devices illustrated are REQUIRED, except those denoted with the triangle symbol may be omitted when stated in the plans, or for routine maintenance work, when approved by the Engineer.
  - Stockpiled material should be placed a minimum of 30 feet from nearest traveled way.
  - Shadow Vehicle with TMA and high intensity rotating, flashing, oscillating or strobe lights. A Shadow Vehicle with a TMA should be used anytime it can be positioned 30 to 100 feet in advance of the area of crew exposure without adversely affecting the performance or quality of the work. If workers are no longer present but road or work conditions require the traffic control to remain in place, Type 3 Barricades or other channelizing devices may be substituted for the Shadow Vehicle and TMA.
  - Additional Shadow Vehicles with TMAs may be positioned off the paved surface, next to those shown in order to protect a wider work space.
  - See TCP(5-1) for shoulder work on divided highways, expressways and freeways.
  - Inactive work vehicles or other equipment should be parked near the right-of-way line and not parked on the paved shoulder.
  - CW21-5 "SHOULDER WORK" signs may be used in place of CW21-1D "ROAD WORK AHEAD" signs for shoulder work on conventional roadways.

**Texas Department of Transportation**  
 Traffic Operations Division Standard

**TRAFFIC CONTROL PLAN**  
**CONVENTIONAL ROAD**  
**SHOULDER WORK**

**TCP (2-1) - 18**

FILE: tcp2-1-18.dgn	DW: TADOT	CK: TXDOT	DW: TXDOT	CK: TXDOT
© TXDOT December 1985	CONT	SECT	JOB	HIGHWAY
2-94 4-98 REVISIONS	E440	15	001	TH 20 ETC.
8-95 2-12	D15T		COUNTY	SHEET NO.
1-97 2-18	02		PALD PRINTO	12

DISCLAIMER: This standard is governed by the "Texas Engineering Practice Act". No warranty of any kind is made by TxDOT for any purpose whatsoever. TxDOT assumes no responsibility for the conversion of this standard to other formats or for incorrect results or damages resulting from its use.

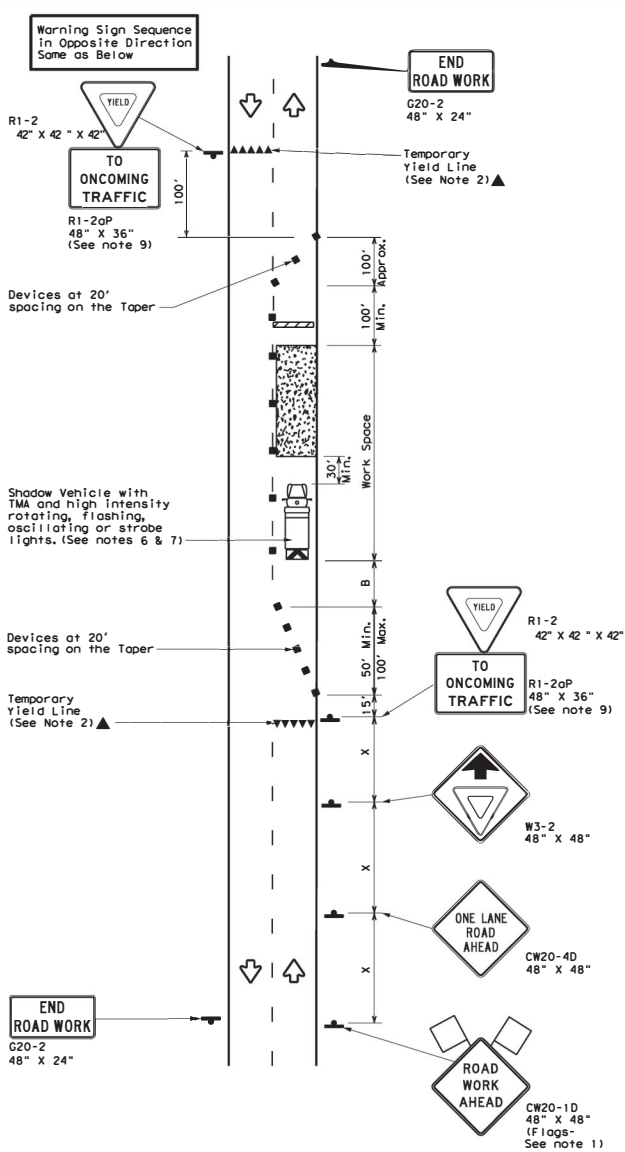

TCP (2-2a)

2-LANE ROADWAY WITHOUT PAVED SHOULDERS  
ONE LANE TWO-WAY  
CONTROL WITH YIELD SIGNS  
(Less than 2000 ADT - See Note 9)

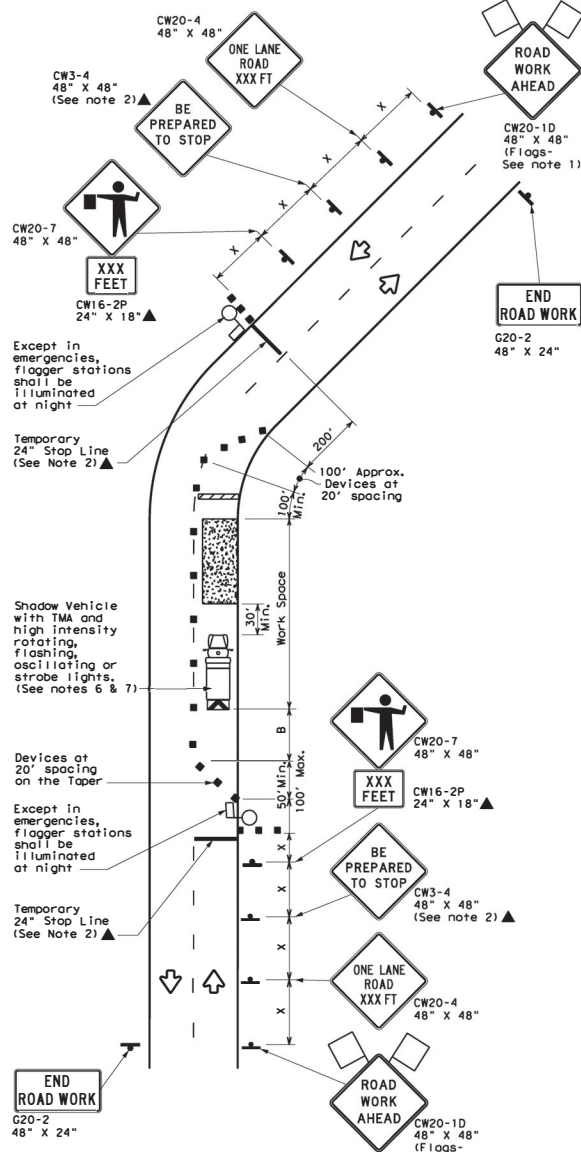

TCP (2-2b)

2-LANE ROADWAY WITHOUT PAVED SHOULDERS  
ONE LANE TWO-WAY  
CONTROL WITH FLAGGERS

LEGEND			
	Type 3 Barricade		Channelizing Devices
	Heavy Work Vehicle		Truck Mounted Attenuator (TMA)
	Trailer Mounted Flashing Arrow Board		Portable Changeable Message Sign (PCMS)
	Sign		Traffic Flow
	Flag		Flagger

Posted Speed * *	Formula L = WS <sup>2</sup> 60	Minimum Desirable Taper Lengths **			Suggested Maximum Spacing of Channelizing Devices		Minimum Sign Spacing * Distance	Suggested Longitudinal Buffer Space "B"	Stopping Sight Distance
		10' Offset	11' Offset	12' Offset	On a Taper	On a Tangent			
30		150'	165'	180'	30'	60'	120'	90'	200'
35		205'	225'	245'	35'	70'	160'	120'	250'
40		265'	295'	320'	40'	80'	240'	155'	305'
45		450'	495'	540'	45'	90'	320'	195'	360'
50		500'	550'	600'	50'	100'	400'	240'	425'
55		550'	605'	660'	55'	110'	500'	295'	495'
60		600'	660'	720'	60'	120'	600'	350'	570'
65		650'	715'	780'	65'	130'	700'	410'	645'
70		700'	770'	840'	70'	140'	800'	475'	730'
75		750'	825'	900'	75'	150'	900'	540'	820'

\* Conventional Roads Only  
\*\* Taper lengths have been rounded off.  
L=Length of Taper(FT) W=Width of Offset(FT) S=Posted Speed(MPH)

TYPICAL USAGE				
MOBILE	SHORT DURATION	SHORT TERM STATIONARY	INTERMEDIATE TERM STATIONARY	LONG TERM STATIONARY
	✓	✓	✓	

**GENERAL NOTES**

- Flags attached to signs where shown, are REQUIRED.
  - All traffic control devices illustrated are REQUIRED, except those denoted with the triangle symbol may be omitted when stated elsewhere in the plans, or for routine maintenance work, when approved by the Engineer.
  - The CW3-4 "BE PREPARED TO STOP" sign may be installed after the CW20-4 "ONE LANE ROAD XXX FT" sign, but proper sign spacing shall be maintained.
  - Flaggers should use two-way radios or other methods of communication to control traffic.
  - Length of work space should be based on the ability of flaggers to communicate.
  - A Shadow Vehicle with a TMA should be used anytime it can be positioned 30 to 100 feet in advance of the area of crew exposure without adversely affecting the performance or quality of the work. If workers are no longer present but road or work conditions require the traffic control to remain in place, Type 3 Barricades or other channelizing devices may be substituted for the Shadow Vehicle and TMA.
  - Additional Shadow Vehicles with TMAs may be positioned off the paved surface, next to those shown in order to protect a wider work space.
- TCP (2-2a)**
- The R1-2 "YIELD" sign traffic control may be used on projects with approaches that have adequate sight distance. For projects in urban areas, work space should be no longer than one half city block. In rural areas, roadways with less than 2000 ADT, work space should be no longer than 400 feet.
  - The R1-2aP "YIELD TO ONCOMING TRAFFIC" sign shall be placed on a support at a 7 foot minimum mounting height.
- TCP (2-2b)**
- Channelizing devices on the center line may be omitted when a pilot car is leading traffic and approved by the Engineer.
  - If the work space is located near a horizontal or vertical curve, the buffer distances should be increased in order to maintain stopping sight distance to the flagger and a queue of stopped vehicles. (See table above).
  - Flaggers should use 24" STOP/SLOW paddles to control traffic. Flags should be limited to emergency situations.

Traffic Operations Division Standard

### TRAFFIC CONTROL PLAN ONE-LANE TWO-WAY TRAFFIC CONTROL

## TCP (2-2) - 18

FILE: tcp2-2-18.dgn	DATE: December 1985	CONTRACT NO.	SECTION	JOB	HIGHWAY
8-95	3-03	E440	15	001	IR 20 ETC.
1-97	2-12	DIST		COUNTY	SHEET NO.
4-98	2-18	02		PALO PINTO	13

1102

DATE: FILE:

DISCOUNTS: The use of this standard is governed by the "Texas Engineering Practice Act". No warranty of any kind is made by TxDOT for any purpose whatsoever. TxDOT assumes no responsibility for the conversion of this standard to other formats or for incorrect results or damages resulting from its use.

DATE: FILE:

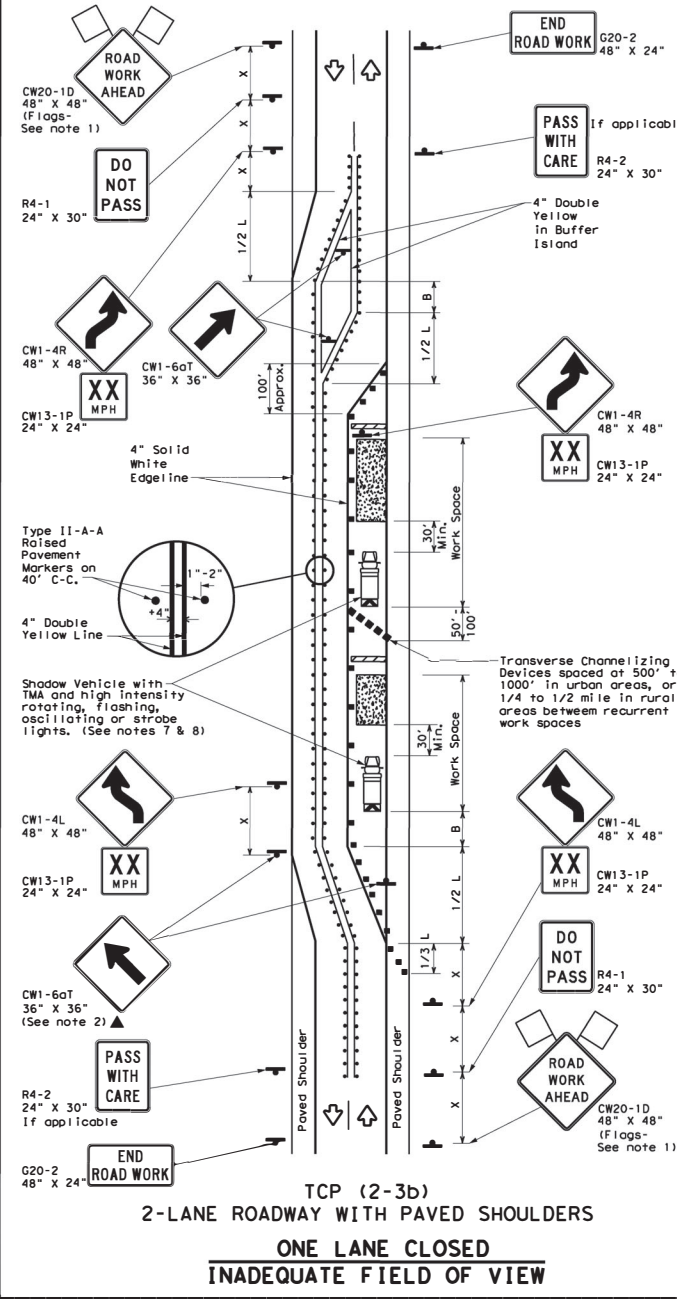
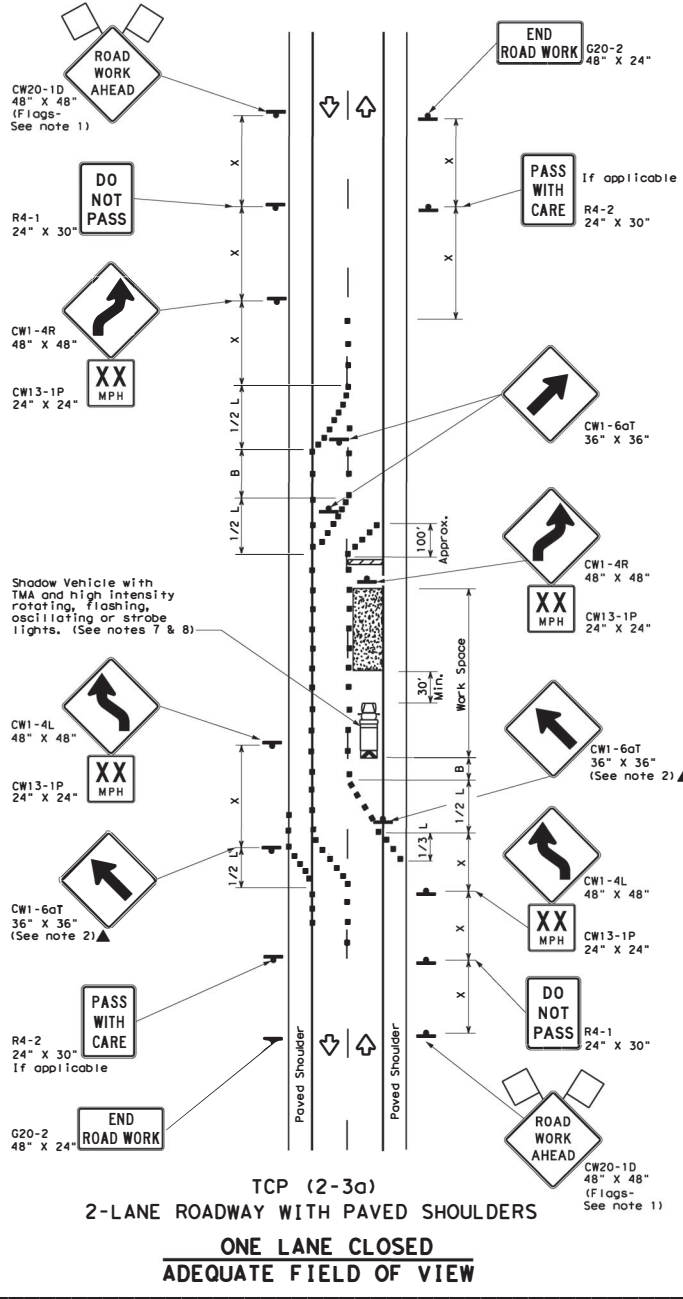

LEGEND			
	Type 3 Barricade		Channelizing Devices
	Heavy Work Vehicle		Truck Mounted Attenuator (TMA)
	Trailer Mounted Flashing Arrow Board		Raised Pavement Markers Ty 11-AA
	Sign		Traffic Flow
	Flag		Flagger

Posted Speed #	Formula	Minimum Desirable Taper Lengths **			Suggested Maximum Spacing of Channelizing Devices		Minimum Sign Spacing Distance "x"	Suggested Longitudinal Buffer Space "B"
		10' Offset	11' Offset	12' Offset	On a Taper	On a Tangent		
30	L = WS <sup>2</sup> / 60	150'	165'	180'	30'	60'	120'	90'
35		205'	225'	245'	35'	70'	160'	120'
40		265'	295'	320'	40'	80'	240'	155'
45	L = WS	450'	495'	540'	45'	90'	320'	195'
50		500'	550'	600'	50'	100'	400'	240'
55		550'	605'	660'	55'	110'	500'	295'
60		600'	660'	720'	60'	120'	600'	350'
65		650'	715'	780'	65'	130'	700'	410'
70	700'	770'	840'	70'	140'	800'	475'	
75	750'	825'	900'	75'	150'	900'	540'	

\* Conventional Roads Only  
 \*\* Taper lengths have been rounded off.  
 L=Length of Taper (FT) W=Width of Offset(FT) S=Posted Speed(MPH)

MOBILE	TYPICAL USAGE			
	SHORT DURATION	SHORT TERM STATIONARY	INTERMEDIATE TERM STATIONARY	LONG TERM STATIONARY
			✓	✓

- GENERAL NOTES**
- Flags attached to signs where shown, are REQUIRED.
  - All traffic control devices illustrated are REQUIRED, except those denoted with the triangle symbol may be omitted when stated elsewhere in the plans, or for routine maintenance work, when approved by the Engineer.
  - When work space will be in place less than three days existing pavement markings may remain in place. Channelizing devices shall be used to separate traffic.
  - Flagger control should NOT be used unless roadway conditions or heavy traffic volume require additional emphasis to safely control traffic. Flagger should be positioned at end of traffic queue.
  - The R4-1 "DO NOT PASS", R4-2 "PASS WITH CARE" and construction regulatory speed zone signs may be installed within CW20-1D "ROAD WORK AHEAD" signs. Proper spacing of signs shall be maintained.
  - Conflicting pavement marking shall be removed for long term projects.
  - A Shadow Vehicle with a TMA should be used anytime it can be positioned 30 to 100 feet in advance of the area of crew exposure without adversely affecting the performance or quality of the work. If workers are no longer present but road or work conditions require the traffic control to remain in place, Type 3 Barricades or other channelizing devices may be substituted.
  - Additional Shadow Vehicles with TMAs may be positioned off the paved surface, next to those shown in order to protect a wider work space.

**TCP (2-3a)**

- Conflicting pavement markings shall be removed for long-term projects. For shorter durations where traffic is directed over a yellow centerline, channelizing devices which separate two-way traffic should be spaced on tapers at 20' or 15' if posted speeds are 35 mph or slower, and for tangent sections, at 1/2(5) where S is the speed in mph. This tighter device spacing is intended for the area of the conflicting markings, not the entire work zone.

Traffic Operations Division Standard

## TRAFFIC CONTROL PLAN

### TRAFFIC SHIFTS ON TWO-LANE ROADS

## TCP (2-3)-18

FILE: tcp(2-3)-18.dgn	DN: TxDOT	CK: TxDOT	DN: TxDOT	CK: TxDOT
© TxDOT December 1985	CONT	SECT	JOB	HIGHWAY
8-95 3-03	6440	15	001	1W 20 ETC.
1-97 2-12	DIST	COUNTY		SHEET NO.
4-98 2-18	02	FALGOUT		14

11/63

DISCLAIMER: The use of this standard is governed by the "Texas Engineering Practice Act". No warranty of any kind is made by TxDOT for any purpose whatsoever. TxDOT assumes no responsibility for the conversion of this standard to other formats or for incorrect results or damages resulting from its use.

DATE: FILE:

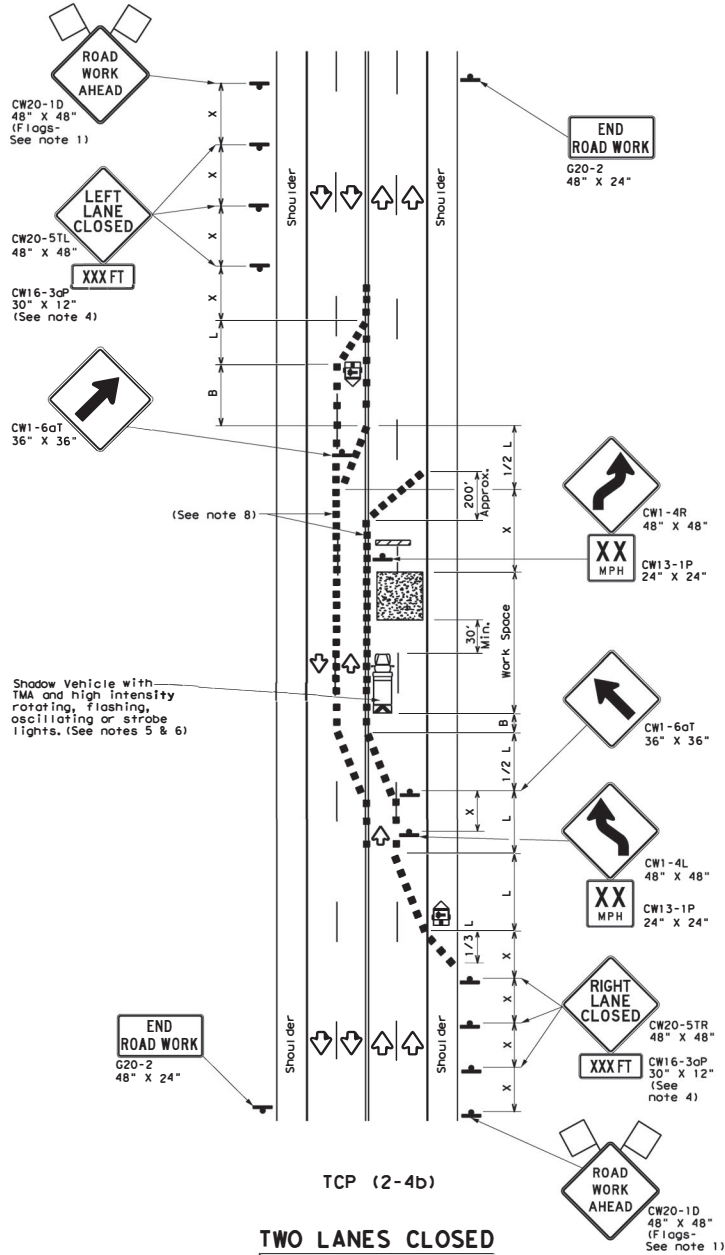
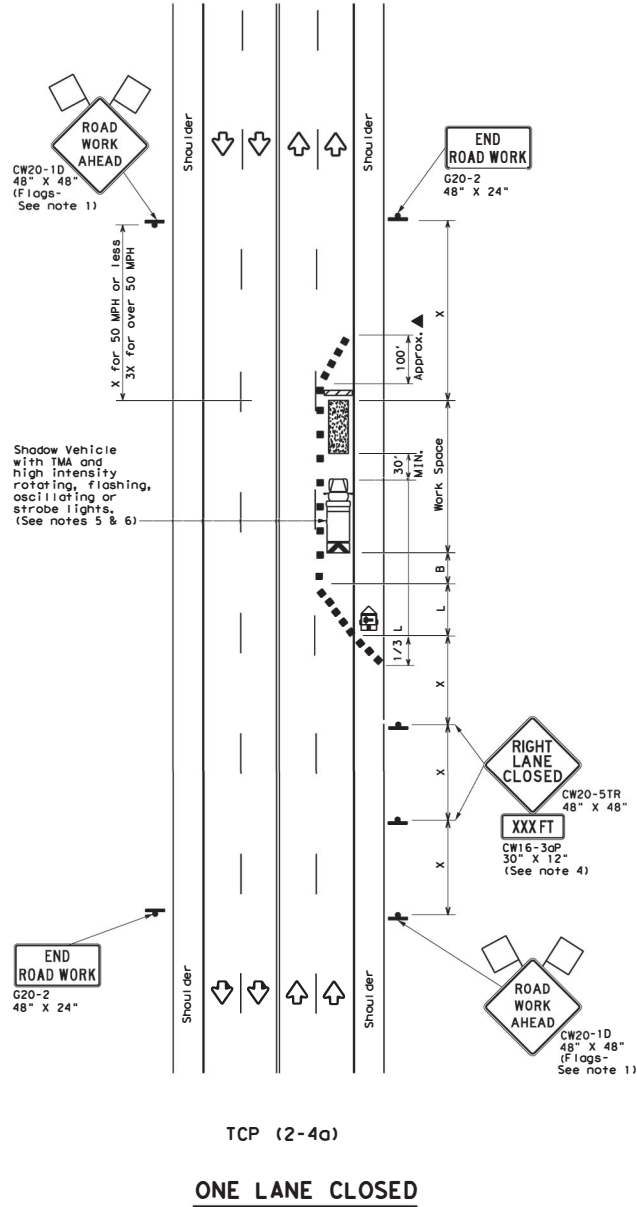

LEGEND			
	Type 3 Barricade		Channelizing Devices
	Heavy Work Vehicle		Truck Mounted Attenuator (TMA)
	Trailer Mounted Flashing Arrow Board		Portable Changeable Message Sign (PCMS)
	Sign		Traffic Flow
	Flag		Flagger

Posted Speed "S"	Formula	Minimum Desirable Taper Lengths "L"			Suggested Maximum Spacing of Channelizing Devices "X"		Minimum Sign Spacing "Y"	Suggested Longitudinal Buffer Space "B"
		10' Offset	11' Offset	12' Offset	On a Taper	On a Tangent		
30	$L = \frac{WS^2}{60}$	150'	165'	180'	30'	60'	120'	90'
35		205'	225'	245'	35'	70'	160'	120'
40		265'	295'	320'	40'	80'	240'	155'
45		330'	365'	395'	45'	90'	320'	195'
50	L = WS	500'	550'	600'	50'	100'	400'	240'
55		550'	605'	660'	55'	110'	500'	295'
60		600'	660'	720'	60'	120'	600'	350'
65		650'	715'	780'	65'	130'	700'	410'
70		700'	770'	840'	70'	140'	800'	475'
75		750'	825'	900'	75'	150'	900'	540'

\* Conventional Roads Only  
 \*\* Taper lengths have been rounded off.  
 L=Length of Taper (FT) W=Width of Offset (FT) S=Posted Speed (MPH)

TYPICAL USAGE				
MOBILE	SHORT DURATION	SHORT TERM STATIONARY	INTERMEDIATE TERM STATIONARY	LONG TERM STATIONARY
		✓	✓	

**GENERAL NOTES**

- Flags attached to signs where shown, are REQUIRED.
  - All traffic control devices illustrated are REQUIRED, except those denoted with the triangle symbol may be omitted when stated elsewhere in the plans, or for routine maintenance work, when approved by the Engineer.
  - The downstream taper is optional. When used, it should be 100 feet minimum length per lane.
  - For short term applications, when post mounted signs are not used, the distance legend may be shown on the sign face rather than on a CW16-3aP supplemental plaque.
  - A Shadow Vehicle with a TMA should be used anytime it can be positioned 30 to 100 feet in advance of the area of crew exposure without adversely affecting the performance or quality of the work. If workers are no longer present but road or work conditions require the traffic control to remain in place, Type 3 Barricades or other channelizing devices may be substituted for the Shadow Vehicle and TMA.
  - Additional Shadow Vehicles with TMAs may be positioned in each closed lane, on the shoulder or off the paved surface, next to those shown in order to protect a wider work space.
- TCP (2-4a)**
- If this TCP is used for a left lane closure, CW20-5TL "LEFT LANE CLOSED" signs shall be used and channelizing devices shall be placed on the centerline to protect the work space from opposing traffic with the arrow board placed in the closed lane near the end of the merging taper.
- TCP (2-4b)**
- For shorter durations where traffic is directed over a yellow centerline, channelizing devices which separate two-way traffic should be spaced on tapers at 20' or 15' if posted speeds are 35 mph or slower, and for tangent sections, at 1/2(S) where S is the speed in mph. This tighter device spacing is intended for the area of conflicting markings, not the entire work zone.

		Traffic Operations Division	
<b>TRAFFIC CONTROL PLAN</b> <b>LANE CLOSURES ON MULTILANE</b> <b>CONVENTIONAL ROADS</b>			
<b>TCP (2-4) - 18</b>			
FILE: tcp2-4-18.dgn	DATE: 12/01/15	BY: JTB	CHECKED: JTB
© TxDOT December 1985	CONTRACT NO. 6440	SECTION 15	JOB NO. 001
8-95 3-03 REVISIONS	DISTRICT	COUNTY	SHEET NO.
1-97 2-12	02	PALO PINTO	15
4-98 2-18			

DISCLAIMER: The use of this standard is governed by the "Texas Engineering Practice Act". No warranty of any kind is made by TxDOT for any purpose whatsoever. TxDOT assumes no responsibility for the conversion of this standard to other formats or for incorrect results or damages resulting from its use.

DATE: FILE:

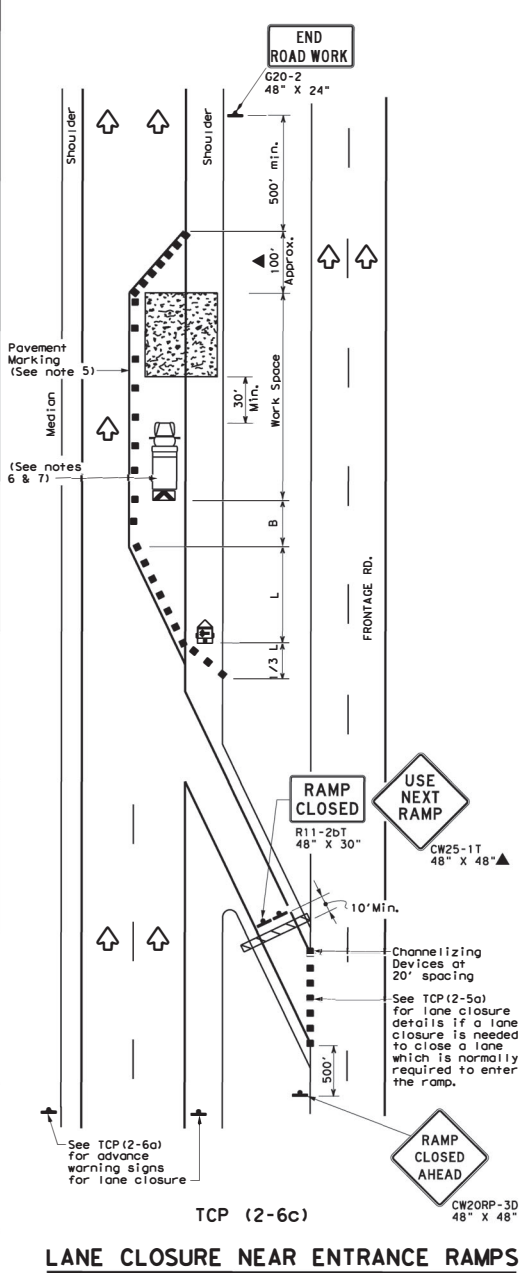
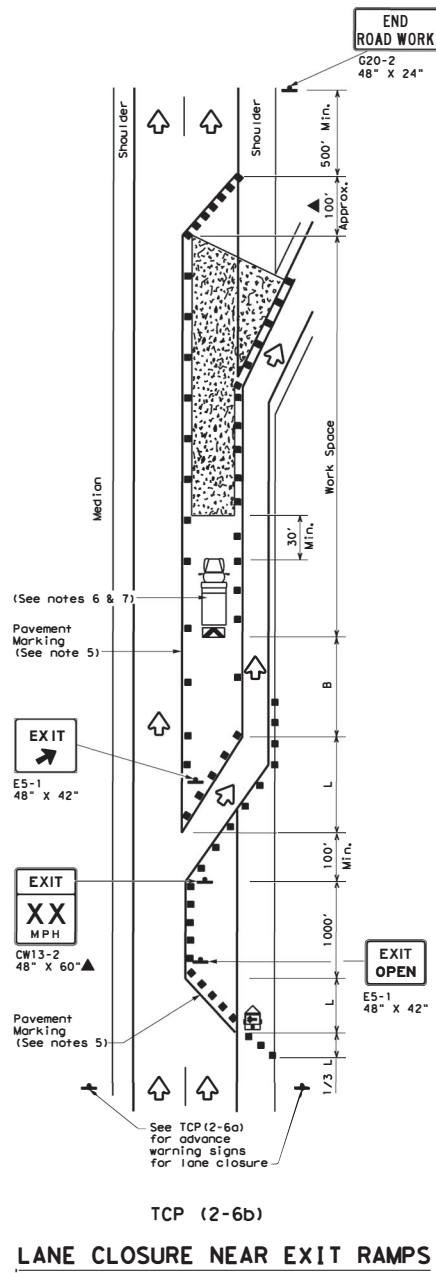
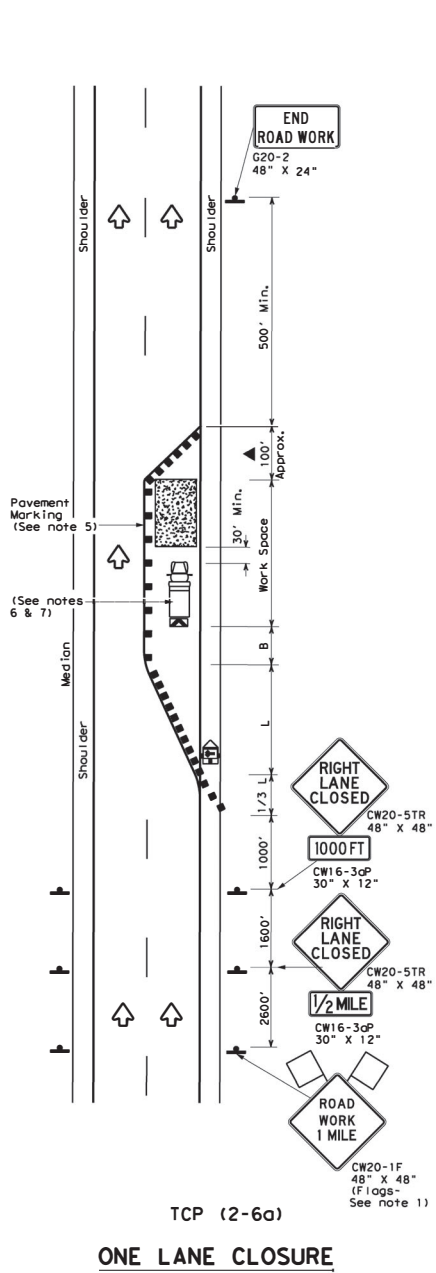

LEGEND			
	Type 3 Barricade		Channelizing Devices
	Heavy Work Vehicle		Truck Mounted Attenuator (TMA)
	Trailer Mounted Flashing Arrow Board		Portable Changeable Message Sign (PCMS)
	Sign		Traffic Flow
	Flag		Flagger

Posted Speed *	Formula	Minimum Desirable Taper Lengths **			Suggested Maximum Spacing of Channelizing Devices		Minimum Sign Spacing * Distance	Suggested Longitudinal Buffer Space -B-
		10' Offset	11' Offset	12' Offset	On a Taper	On a Tangent		
30	L = WS <sup>2</sup> / 60	150'	165'	180'	30'	60'	120'	90'
35		205'	225'	245'	35'	70'	160'	120'
40		265'	295'	320'	40'	80'	240'	155'
45	L = WS	450'	495'	540'	45'	90'	320'	195'
50		500'	550'	600'	50'	100'	400'	240'
55		550'	605'	660'	55'	110'	500'	295'
60		600'	660'	720'	60'	120'	600'	350'
65		650'	715'	780'	65'	130'	700'	410'
70		700'	770'	840'	70'	140'	800'	475'
75		750'	825'	900'	75'	150'	900'	540'

\* Conventional Roads Only  
 \*\* Taper lengths have been rounded off.  
 L = Length of Taper (FT) W = Width of Offset (FT) S = Posted Speed (MPH)

TYPICAL USAGE			
MOBILE	SHORT DURATION	SHORT TERM STATIONARY	LONG TERM STATIONARY

- GENERAL NOTES**
- Flags attached to signs where shown, are REQUIRED.
  - All traffic control devices illustrated are REQUIRED, except those denoted with the triangle symbol may be omitted when stated elsewhere in the plans, or for routine maintenance work, when approved by the Engineer.
  - Channelizing devices used to close lanes may be supplemented with the Chevron Alignment Sign placed on every other channelizing device. Chevrons may be attached to plastic drums or per BC Standards.
  - Channelizing devices used along the work space or along tangent sections may be supplemented with vertical panels (VP) placed on every other channelizing device. If night time conditions make it difficult to see at least two VPs, the VPs may be placed on each channelizing device.
  - The placement of pavement markings may be omitted on intermediate-term stationary work zones with the approval of the Engineer.
  - Shadow Vehicle with TMA and high intensity rotating, flashing, oscillating or strobe lights. Shadow Vehicle with TMA and high intensity rotating, flashing, oscillating or strobe lights. A Shadow Vehicle with a TMA should be used anytime it can be positioned 30 to 100 feet in advance of the area of crew exposure without adversely affecting the performance or quality of the work. If workers are no longer present but road or work conditions require the traffic control to remain in place, Type 3 Barricades or other channelizing devices may be substituted for the Shadow Vehicle and TMA.
  - Additional Shadow Vehicles with TMAs may be positioned in each closed lane, on the shoulder or off the paved surface, next to those shown in order to protect a wider work space.

**TRAFFIC CONTROL PLAN**  
**LANE CLOSURES ON**  
**DIVIDED HIGHWAYS**  
**TCP (2-6) - 18**

FILE: tcp2-6-18.dgn	DN: TxDOT	CK: TxDOT	DR: TxDOT	CK: TxDOT
© TxDOT December 1985	CONT	SECT	JOB	HIGHWAY
REVISIONS	6440	15	001	14 20 ETC.
2-94 4-98	DIST		COUNTY	SHEET NO.
8-95 2-12				
1-97 2-18				
			PALD PRINTO	16

DISCLAIMER: The use of this standard is governed by the "Texas Engineering Practice Act". No warranty of any kind is made by TxDOT for any purpose whatsoever. TxDOT assumes no responsibility for the conversion of this standard to other formats or for incorrect results or damages resulting from its use.

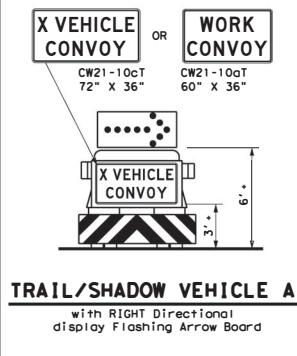
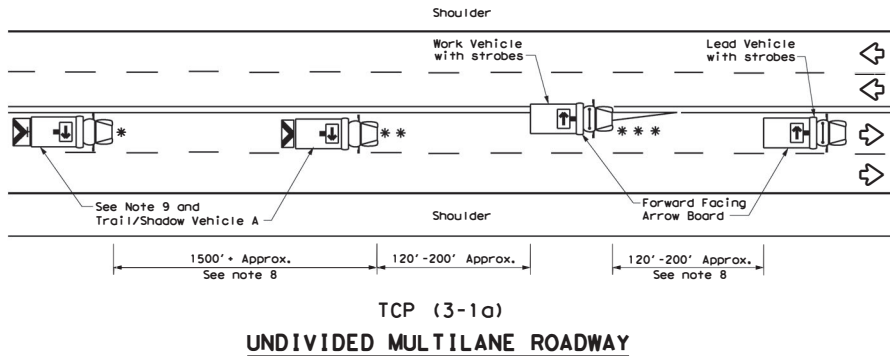

LEGEND	
* Trail Vehicle	ARROW BOARD DISPLAY
** Shadow Vehicle	
*** Work Vehicle	RIGHT Directional
Heavy Work Vehicle	LEFT Directional
Truck Mounted Attenuator (TMA)	Double Arrow
Traffic Flow	CAUTION (Alternating Diamond or 4 Corner Flash)

TYPICAL USAGE			
MOBILE	SHORT DURATION	SHORT TERM STATIONARY	LONG TERM STATIONARY
✓			

- GENERAL NOTES**
- TRAIL, SHADOW, and LEAD vehicles shall be equipped with arrow boards as illustrated. When a LEAD vehicle is not used the WORK vehicle must be equipped with an arrow board. The Engineer will determine if the LEAD VEHICLE and/or TRAIL VEHICLE are required based on prevailing roadway conditions, traffic volume, and sight distance restrictions.
  - The use of amber high intensity rotating, flashing, oscillating, or strobe lights on vehicles are required. Blue high intensity rotating, flashing, oscillating or strobe lights when mounted on the driver's side of the vehicle may be operated simultaneously with the amber beacons or strobe lights.
  - The use of truck mounted attenuators (TMA) on the SHADOW VEHICLE and TRAIL VEHICLE are required.
  - Reflective sheeting on the rear of the TMA shall meet or exceed the reflectivity and color requirements of DEPARTMENTAL MATERIAL SPECIFICATION DMS 8300, Type A.
  - Flashing arrow boards shall be Type B or Type C as per the Barricade and Construction (BC) standards. The board shall be controlled from inside the vehicle.
  - Each vehicle shall have two-way radio communication capability.
  - When work convoys must change lanes, the TRAIL VEHICLE should change lanes first to shadow the other convoy vehicles.
  - Vehicle spacing between the TRAIL VEHICLE and the SHADOW VEHICLE will vary depending on sight distance restrictions. Motorists approaching the work convoy should be able to see the TRAIL VEHICLE in time to slow down and/or change lanes as they approach the TRAIL VEHICLE. Vehicle spacing between the WORK VEHICLE and SHADOW VEHICLE and vehicle spacing between WORK VEHICLE and LEAD VEHICLE may vary according to terrain, work activity and other factors.
  - "X VEHICLE CONVOY" (CW21-10cT) or "WORK CONVOY" (CW21-10aT) signs shall be used on TRAIL VEHICLES and SHADOW VEHICLES as shown. As an option 48" X 48" diamond shaped "WORK CONVOY" (CW21-10T) or "X VEHICLE CONVOY" (CW21-10bT) signs may be used where adequate mounting space exists. When used, the X VEHICLE CONVOY sign shall have the number of the convoy vehicles displayed on the sign in the number designation "X" location. The "X VEHICLE CONVOY" sign shall not be used on the SHADOW VEHICLE if a TRAIL VEHICLE is used.
  - On two-lane two-way roadways, the work and protection vehicles should pull over periodically to allow motor vehicle traffic to pass. If motorists are not allowed to pass the work convoy, a "DO NOT PASS" (R4-1) sign should be placed on the back of the rearmost protection vehicle.

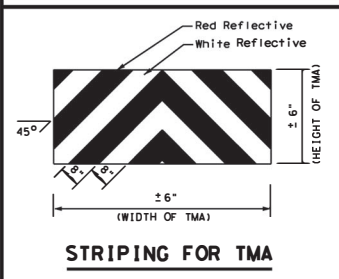
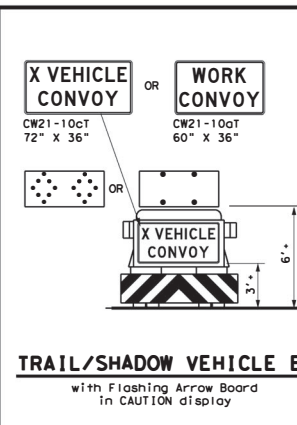
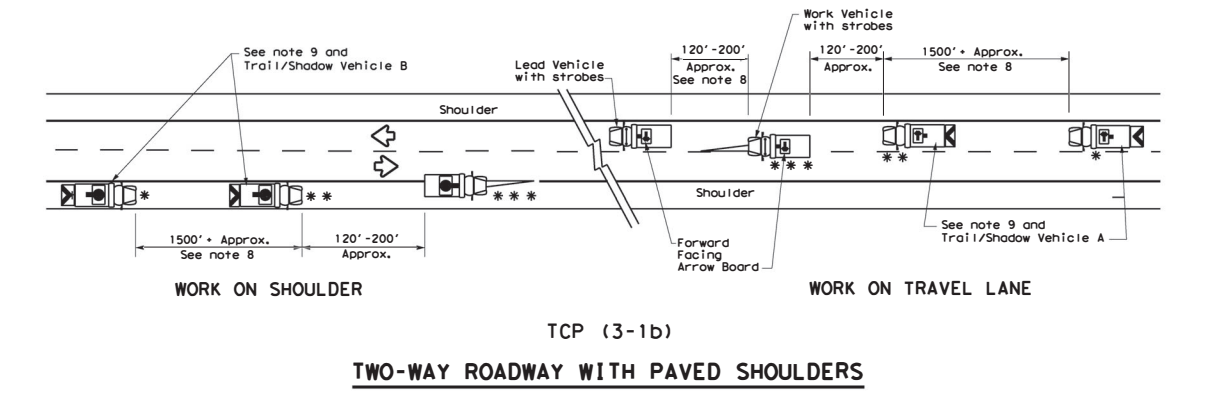

Texas Department of Transportation  
Traffic Operations Division Standard

**TRAFFIC CONTROL PLAN  
MOBILE OPERATIONS  
UNDIVIDED HIGHWAYS**

**TCP (3-1)-13**

FILE: tcp3-1.dgn	DN: TxDOT	CS: TxDOT	DN: TxDOT	CS: TxDOT
© TxDOT December 1985	CONT: SECT	JOB: HIGHWAY		
REVISIONS	6490 15	001	1H 20, ETC.	
2-94 4-98	DIST: COUNTY	SHEET NO.		
8-95 7-13	ETW	PALO PINTO	17	
1-97				

DATE: FILE:



DISCLAIMER: This standard is governed by the "Texas Engineering Practice Act". No warranty of any kind is made by TxDOT for any purpose whatsoever. TxDOT assumes no responsibility for the conversion of this standard to other formats or for incorrect results or damages resulting from its use.

DATE: FILE:

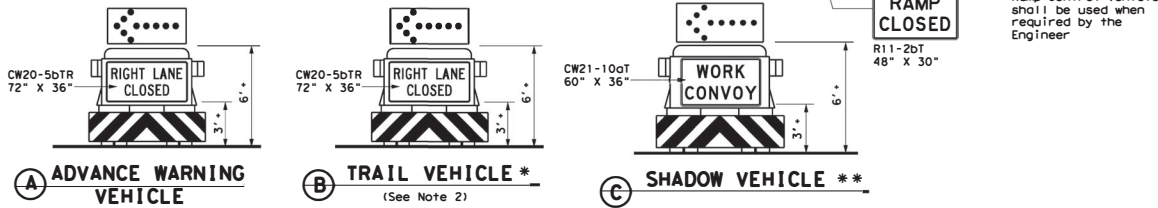
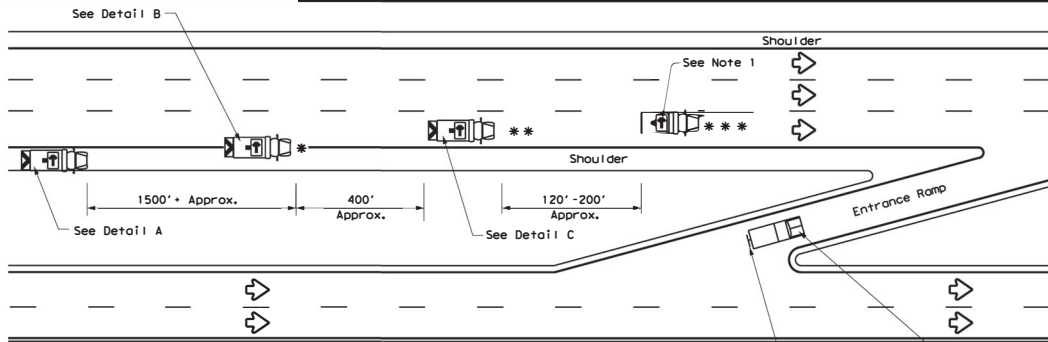

**RIGHT LANE CLOSURE ON DIVIDED HIGHWAY - TCP (3-2a)**

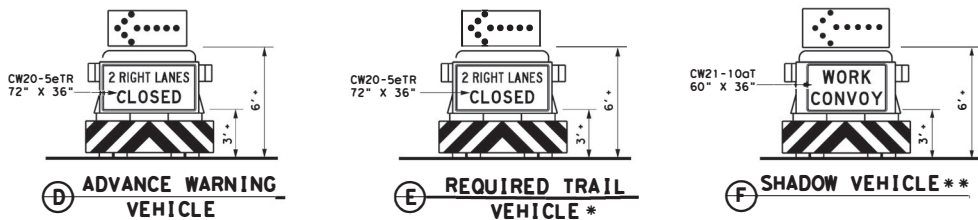
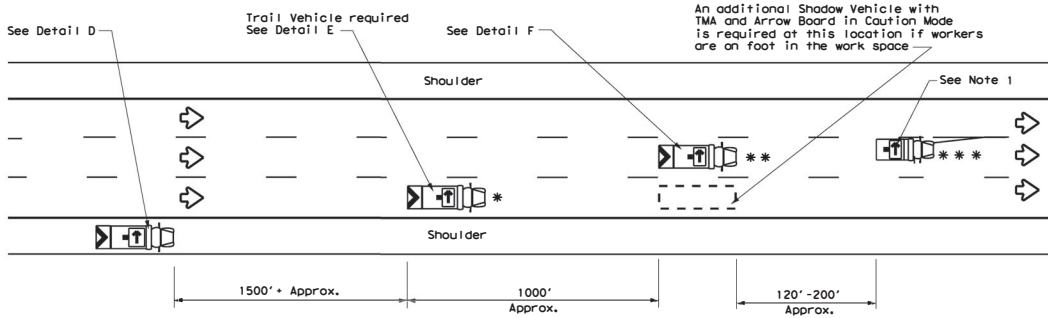

**INTERIOR LANE CLOSURE ON MULTI-LANE DIVIDED HIGHWAY - TCP (3-2b)**

LEGEND	
* Trail Vehicle	ARROW BOARD DISPLAY
** Shadow Vehicle	
*** Work Vehicle	
Heavy Work Vehicle	RIGHT Directional
Truck Mounted Attenuator (TMA)	LEFT Directional
Traffic Flow	Double Arrow
	CAUTION (Alternating Diamond or 4 Corner Flash)

TYPICAL USAGE				
MOBILE	SHORT DURATION	SHORT TERM STATIONARY	INTERMEDIATE TERM STATIONARY	LONG TERM STATIONARY
✓				

**GENERAL NOTES**

- ADVANCE WARNING, TRAIL and SHADOW vehicles shall be equipped with Type B or Type C flashing arrow boards as per the Barricade and Construction (BC) standards. Arrow boards on WORK vehicles will be optional based on the type of work being performed. The arrow boards shall be operated from inside the vehicle.
- For TCP(3-2a) the Engineer will determine if the TRAIL VEHICLE is required based on prevailing roadway conditions, traffic volume, and sight distance restrictions. All other vehicles shown for both TCP(3-2a) and TCP(3-2b) are required.
- The use of amber high intensity rotating, flashing, oscillating, or strobe lights on vehicles are required. Blue high intensity rotating, flashing, oscillating or strobe lights when mounted on the driver's side of the vehicle may be operated simultaneously with the amber beacons or strobe lights.
- The use of truck mounted attenuators (TMA) on the ADVANCE WARNING, SHADOW, and TRAIL vehicles are required.
- Reflective sheeting on the rear of the TMA shall meet or exceed the reflectivity and color requirements of DMS 8300, Type A.
- Each vehicle shall have two-way radio communication capability.
- When work convoys must change lanes, the TRAIL VEHICLE should change lanes first to shadow the other convoy vehicles.
- Vehicle spacing between the TRAIL VEHICLE and the SHADOW VEHICLE will vary depending on sight distance restrictions. Motorists approaching the work convoy should be able to see the TRAIL VEHICLE in time to slow down and/or change lanes as they approach the TRAIL VEHICLE. Vehicle spacing between the WORK VEHICLE and SHADOW VEHICLE may vary according to terrain, work activity and other factors.
- Standard 48" X 48" diamond shaped warning signs with the same message as those shown may be used where adequate mounting space exists.
- The signs shown should be used on the Advance Warning Vehicle. As an option, a portable changeable message sign (PCMS) or a truck mounted changeable message sign (TMCMS) with a minimum character height of 12", and displaying the same legend may be substituted for these signs. An appropriate directional arrow display, simulating the size and legibility of the flashing arrow board, must be used in the second phase of the PCMS/TMCMS message. When this is done, the arrow board will not be required on the Advance Warning Vehicle.
- Standard diamond shape versions of the CW20-5 series signs may be used as an option if the rectangular signs shown are not available.
- The principles on this sheet may be used to close lanes from the left side of the roadway considering the number of lanes, shoulder width, sight distance, and ramp frequency.
- Signs and flashing arrow board modes shall be appropriately altered when implementing left lane closures or interior closures which close the left lanes.
- The Advance Warning Vehicle may straddle the edgeline when shoulder width makes it necessary.

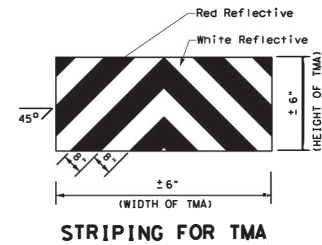

**STRIPING FOR TMA**

		<b>Traffic Operations Division Standard</b>	
<b>TRAFFIC CONTROL PLAN MOBILE OPERATIONS DIVIDED HIGHWAYS</b>			
<b>TCP (3-2) - 13</b>			
FILES: tcp3-2, dgn	DWG: TxDOT	CHK: TxDOT	DWG: TxDOT
© TxDOT December 1985	CONT: 15	SECT: 001	JOB: HIGHWAY
2-94 4-98 REVISIONS	DIST: 02	COUNTY: PALO PINTO	SHEET NO.: 18
8-95 7-13			
1-97			

DISCLAIMER: The use of this standard is governed by the "Texas Engineering Practice Act". No warranty of any kind is made by TxDOT for any purpose whatsoever. TxDOT assumes no responsibility for the conversion of this standard to other formats or for incorrect results or damages resulting from its use.

DATE: FILE:

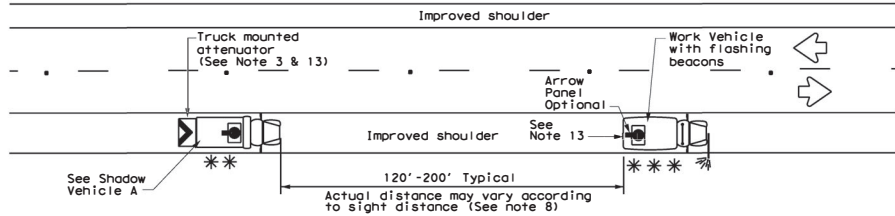

**TWO LANE HIGHWAY WITH PAVED SHOULDERS MINIMUM 8'**

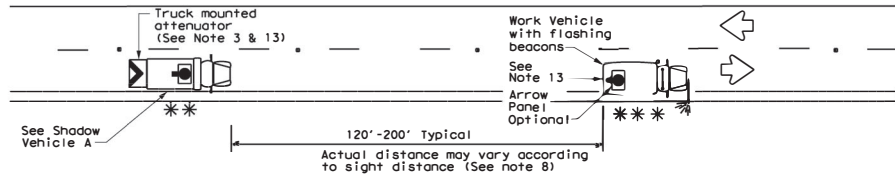

**TWO LANE HIGHWAY WITH NO SHOULDER OR NARROW SHOULDER**

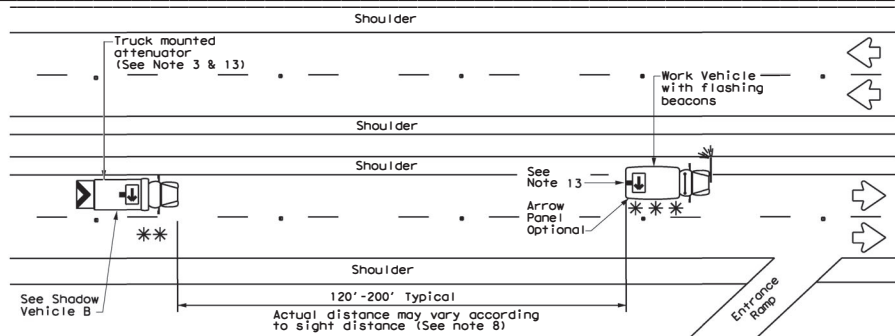

**MULTILANE HIGHWAY**

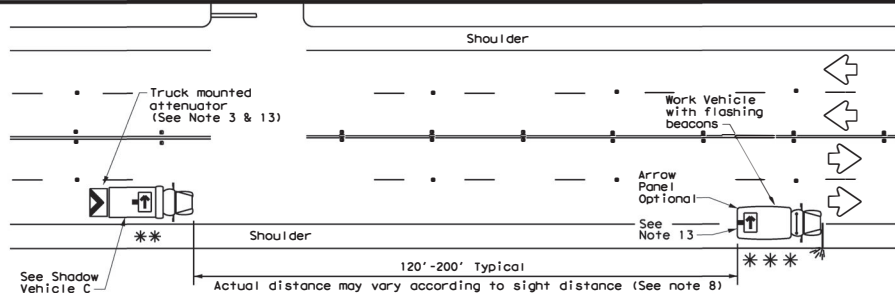

**MULTILANE HIGHWAY**

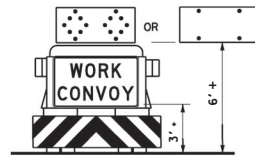
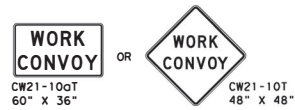

**SHADOW VEHICLE A**  
with Flashing Arrow Board in Caution Mode

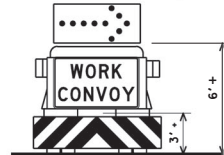

**TYPICAL SHADOW VEHICLE B**  
with RIGHT Directional display  
Flashing Arrow Board

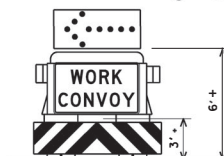

**TYPICAL SHADOW VEHICLE C**  
with LEFT Directional display  
Flashing Arrow Board

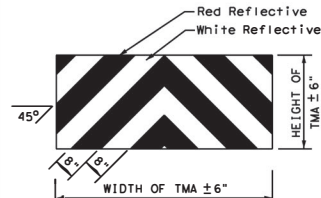

**STRIPING FOR TMA**

**LEGEND**

**	Shadow Vehicle	ARROW BOARD DISPLAY	
***	Work Vehicle		
⬆	Sign	➡	RIGHT Directional
⬇	Heavy Work Vehicle	⬅	LEFT Directional
↔	Traffic Flow	↔	Double Arrow
⚠	Truck Mounted Attenuator (TMA) or Trailer Attenuator (TA)	⚠	CAUTION (Alternating Diamond or 4 Corner Flash)

TYPICAL USAGE			
MOBILE	SHORT DURATION	SHORT TERM STATIONARY	LONG TERM STATIONARY
✓			

**GENERAL NOTES**

- All traffic control devices shall be in accordance with the "Texas Manual on Uniform Traffic Control Devices" (TMUTCD), latest edition.
- The use of amber high intensity rotating, flashing, oscillating, or strobe lights on vehicles are required. Blue high intensity rotating, flashing, oscillating or strobe lights when mounted on the driver's side of the vehicle may be operated simultaneously with the amber beacons or strobe lights.
- The use of truck mounted attenuators (TMA) on the Shadow Vehicle is required.
- Striping on the back panel of all TMAs shall be 8" red reflective sheeting with white background, placed in an inverted "V" design. Reflective sheeting shall meet or exceed the reflectivity and color requirements of DEPARTMENTAL MATERIAL SPECIFICATION DMS-8300, TYPE A.
- Flashing Arrow Panels shall be Type B or Type C as per BC Standards. The panel operation shall be controlled from inside the vehicle.
- Each vehicle shall have two-way radio communication capability.
- When the work convoy must change lanes, the Shadow Vehicle should change lanes first to protect the Work Vehicle.
- Spacing between Shadow and Work Vehicle will vary depending on sight distance restrictions. Motorists approaching the work convoy should be able to see the Shadow Vehicle in time to slow down and/or change lanes as they approach the Work Convoy.
- Use of an arrow panel on the Work Vehicle is optional except as provided in note 13, but may be required by the Engineer. If an arrow panel is not used, dual flashing beacons, mounted as high and as widely separated as practicable at the rear of the Work Vehicle shall be required.
- On two-lane two-way roadways, the Work and Shadow Vehicles should pull over periodically to allow motor vehicle traffic to pass.
- Work and Shadow Vehicles should stay on the shoulder of highways having 8' or wider shoulders when possible.
- A Trail Vehicle may be added to the operation when approved by the Engineer. See TCP(3) series standards.
- The shadow vehicle may be omitted on conventional roadways when a TMA or TA and arrow panel is mounted to the herbicide vehicle. A separate shadow vehicle will be required on expressways and Freeways.



**TRAFFIC CONTROL PLAN  
MOBILE OPERATIONS  
HERBICIDE TRUCK  
OPERATIONS  
TCP(3-5)-18**

FILES: tcp3-5.dgn	DN: TxDOT	CK: TxDOT	DM: TxDOT	CK: TxDOT
© TxDOT July 2015	CONT	BECT	JOB	HIGHWAY
REVISIONS	6440	15	001	SH 20, ETC.
4-18	DIST	COUNTY	SHEET NO.	
	02	FALCO PINTO	19	

DISCLAIMER: The use of this standard is governed by the "Texas Engineering Practice Act". No warranty of any kind is made by TxDOT for any purpose whatsoever. TxDOT assumes no responsibility for the conversion of this standard to other formats or for incorrect results or damages resulting from its use.

DATE: FILE:

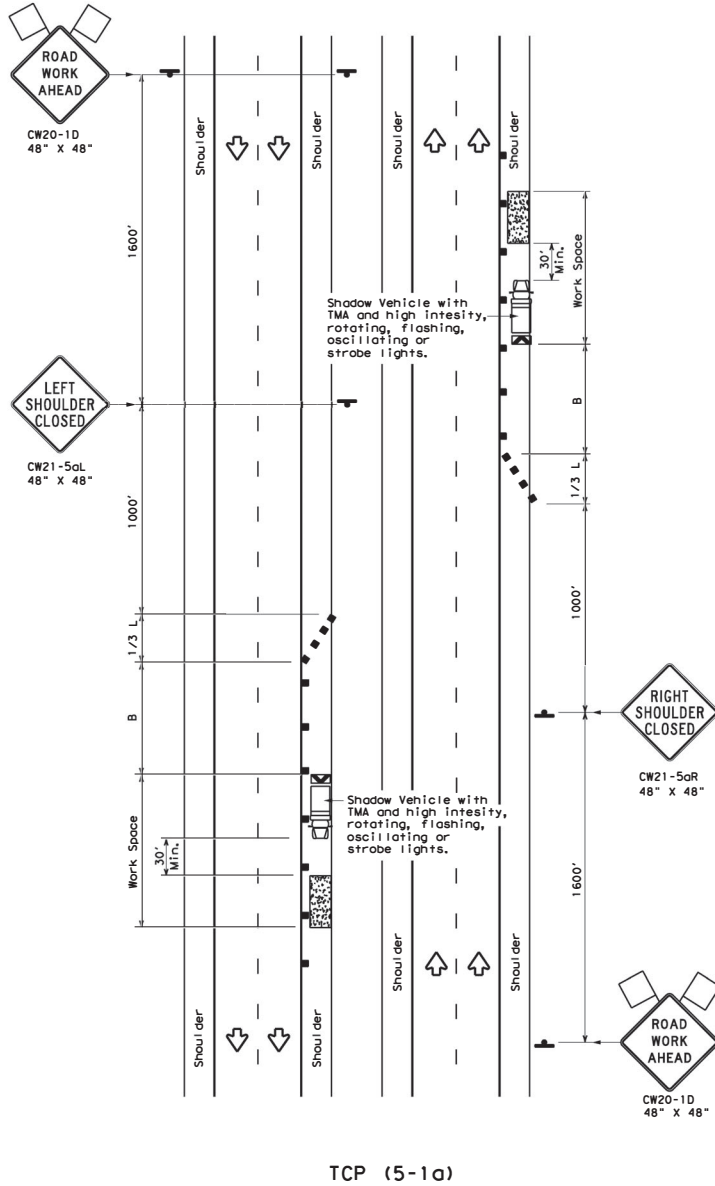

TCP (5-1a)

**WORK AREA ON SHOULDER**

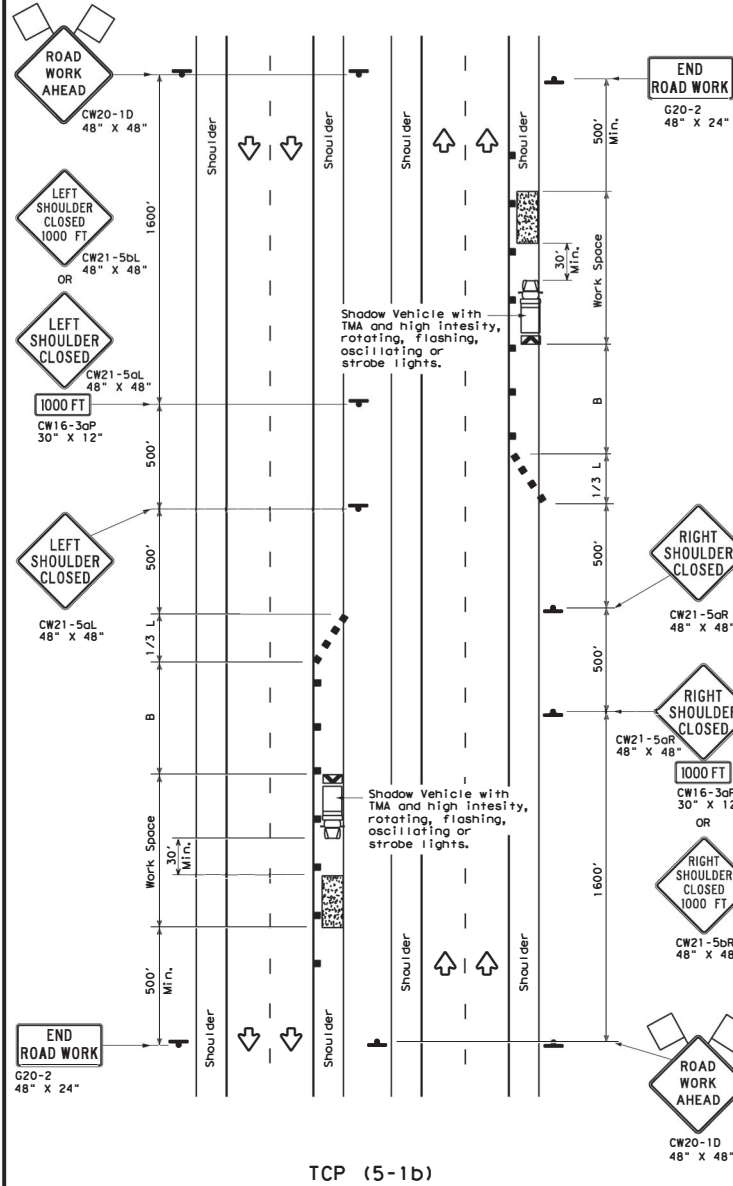

TCP (5-1b)

**WORK AREA ON SHOULDER**

LEGEND			
	Type 3 Barricade		Channelizing Devices
	Heavy Work Vehicle		Truck Mounted Attenuator (TMA)
	Trailer Mounted Flashing Arrow Board		Portable Changeable Message Sign (PCMS)
	Sign		Traffic Flow
	Flag		Flagger

Posted Speed X	Formula	Minimum Desirable Taper Lengths X X X			Suggested Maximum Spacing of Channelizing Devices		Suggested Longitudinal Buffer Space B
		10' Offset	11' Offset	12' Offset	On a Taper	On a Tangent	
30	$L = \frac{WS^2}{60}$	150'	165'	180'	30'	60'	90'
35		205'	225'	245'	35'	70'	120'
40		265'	295'	320'	40'	80'	155'
45		450'	495'	540'	45'	90'	195'
50	L = WS	500'	550'	600'	50'	100'	240'
55		600'	660'	720'	60'	120'	350'
60		650'	715'	780'	65'	130'	410'
65		700'	770'	840'	70'	140'	475'
70		750'	825'	900'	75'	150'	540'
75		800'	880'	960'	80'	160'	615'
80							

\* Conventional Roads Only  
 \*\* Taper lengths have been rounded off.  
 L=Length of Taper (FT) W=Width of Offset (FT) S=Posted Speed (MPH)

TYPICAL USAGE				
MOBILE	SHORT DURATION	SHORT TERM STATIONARY	INTERMEDIATE TERM STATIONARY	LONG TERM STATIONARY
	TCP (5-1a)	TCP (5-1b)	TCP (5-1b)	

**GENERAL NOTES**

- A Shadow Vehicle with a TMA should be used anytime it can be positioned 30' to 100' in advance of the area of crew exposure without adversely affecting the performance or quality of the work. Type 3 barricades or drums may be substituted when workers on foot are no longer present when approved by the Engineer.
- 28" tall or taller one-piece cones will be allowed only for Short Duration or Short Term stationary operations when workers are present to maintain the devices upright and in proper location. Intermediate Term stationary work areas should use Drums, Vertical Panels or 42" tall two-piece cones.



**TRAFFIC CONTROL PLAN  
 SHOULDER WORK FOR  
 FREEWAYS / EXPRESSWAYS**

**TCP (5-1) - 18**

FILE: tcp5-1-18.dgn	DN:TXDOT	CK:TXDOT	DN:TXDOT	CK:TXDOT
© TXDOT February 2012	CONT	SECT	JOB	HIGHWAY
REVISIONS	6440	15	001	14 20 ETC.
2-18	DIST	COUNTY	SHEET NO.	
	02	FALG PINTO	20	

119V

DISCLAIMER: This standard is governed by the "Texas Engineering Practice Act". No warranty of any kind is made by TxDOT for any purpose whatsoever. TxDOT assumes no responsibility for the conversion of this standard to other formats or for incorrect results or damages resulting from its use.

DATE: FILE:

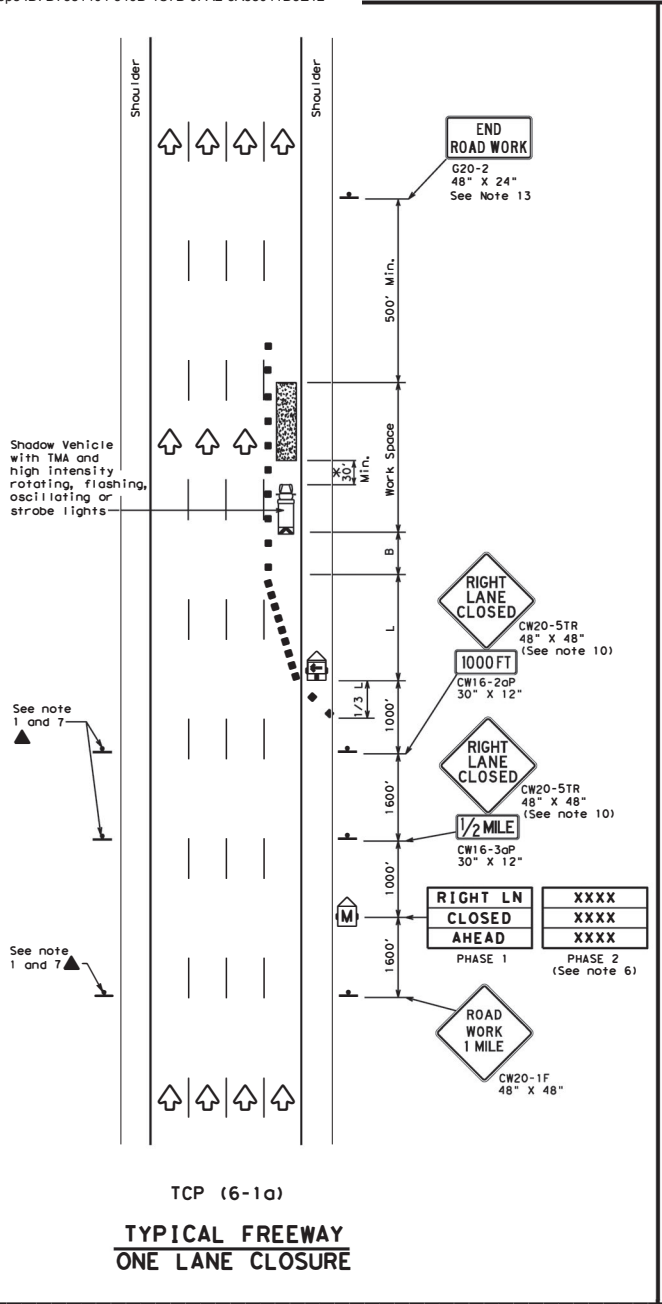

TCP (6-1-a)  
**TYPICAL FREEWAY  
ONE LANE CLOSURE**

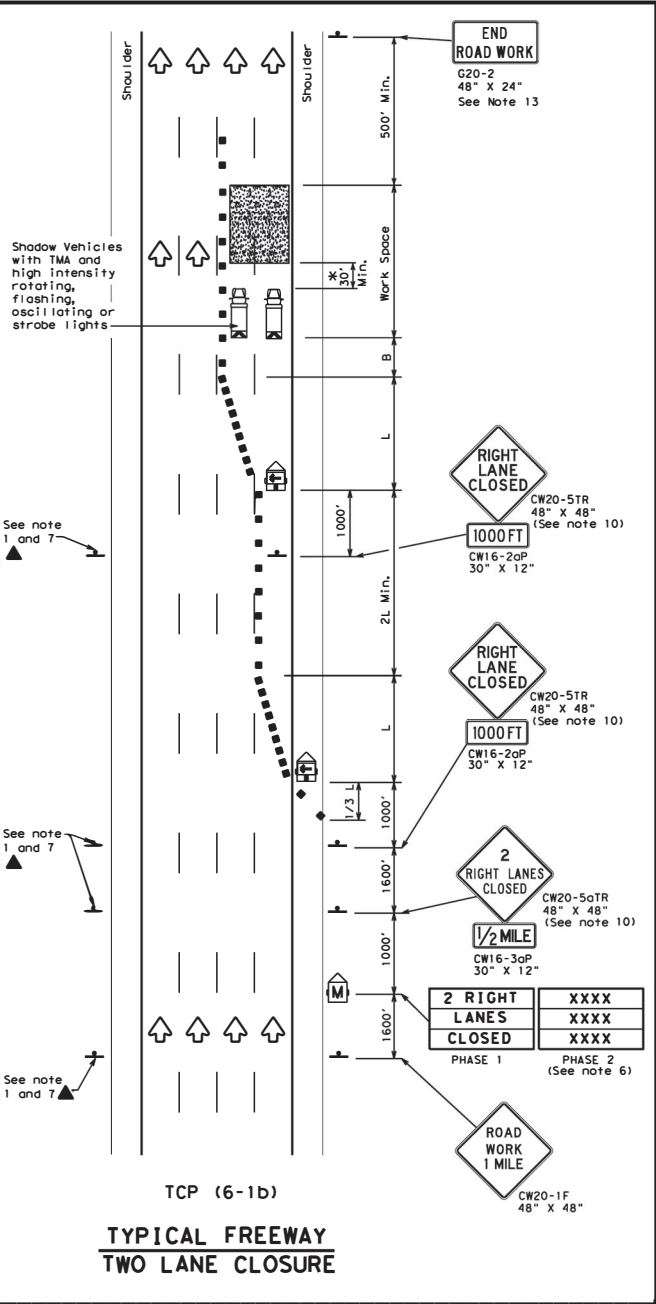

TCP (6-1-b)  
**TYPICAL FREEWAY  
TWO LANE CLOSURE**

LEGEND			
	Type 3 Barricade		Channelizing Devices
	Heavy Work Vehicle		Truck Mounted Attenuator (TMA)
	Trailer Mounted Flashing Arrow Board		Portable Changeable Message Sign (PCMS)
	Sign		Traffic Flow
	Flag		Flagger

Posted Speed	Formula	Minimum Desirable Taper Lengths "L"			Suggested Maximum Spacing of Channelizing Devices		Suggested Longitudinal Buffer Space "B"
		10' Offset	11' Offset	12' Offset	On a Taper	On a Tangent	
45	L + WS	450'	495'	540'	45'	90'	195'
50		500'	550'	600'	50'	100'	240'
55		550'	605'	660'	55'	110'	295'
60		600'	660'	720'	60'	120'	350'
65		650'	715'	780'	65'	130'	410'
70		700'	770'	840'	70'	140'	475'
75		750'	825'	900'	75'	150'	540'
80		800'	880'	960'	80'	160'	615'

\*\*Taper lengths have been rounded off.  
L=Length of Taper (FT) W=Width of Offset (FT) S=Posted Speed (MPH)

TYPICAL USAGE				
MOBILE	SHORT DURATION	SHORT TERM STATIONARY	INTERMEDIATE TERM STATIONARY	LONG TERM STATIONARY
	✓	✓	✓	

- GENERAL NOTES**
- All traffic control devices illustrated are REQUIRED. Devices denoted with the triangle symbol may be omitted when stated elsewhere in the plans.
  - Drums or 42" cones are the typical channelizing devices. For Intermediate Term Stationary work, drums shall be used on tapers with drums or 42" cones used on tangent sections. Other channelizing devices may be used as directed by the Engineer.
  - All construction signs and barricades placed during any phase of work shall remain in place until removal is approved by the Engineer.
  - The Engineer may direct the Contractor to furnish additional signs and barricades as required to maintain traffic flow, detours and motorist safety during construction.
  - Static message boards or changeable message signs stating the date and duration of ramp or freeway lane closures shall be placed a minimum of seven (7) calendar days in advance of the actual closure.
  - Phase 2 of the PMS message should include appropriate information formatted as shown on BC(6), such as "MERGE LEFT," recommended advisory speed, delay information, or other specific warnings.
  - Duplicate construction warning signs should be erected on the medians side of freeways where median width will permit and traffic volume justifies the signing.
  - The number of closed lanes may be increased provided the spacing of traffic control devices, taper lengths and tangent lengths meet the requirements of the TMT/CD.
  - Warning signs for intermediate term stationary work should be mounted at 7' to the bottom of the sign.
  - Warning signs shown shall be appropriately altered for left lane closures. When signs are mounted at 1' height for short term stationary or short duration work, sign versions shown in the SHSD for Texas with distances on the sign face rather than mounted on a plaque below the sign may be used.
  - When possible, PMS units should be located in advance of the last available exit ramp prior to the lane closure to allow motorists an alternate route. They may also be relocated to improve advance warning in case of unanticipated queuing or congestion.
  - For Intermediate Term Stationary work at night, floodlights should be used to illuminate the work area and equipment crossings. Floodlights shall not produce a disabling glare condition for road users or workers.
  - The END ROAD WORK (G20-2) sign may be omitted when it conflicts with G20-2 signs already in place on the project.

\*A shadow vehicle equipped with a Truck Mounted Attenuator is typically required. A shadow vehicle equipped with a TMA shall be used if it can be positioned 30' to 100' in advance of the area of crew exposure without adversely affecting the work performance.

**Texas Department of Transportation**  
Traffic Operations Division Standard

**TRAFFIC CONTROL PLAN  
FREEWAY LANE CLOSURES**

**TCP (6-1) - 12**

FILE: tcp6-1.dgn	DN: TxDOT	CK: TxDOT	DM: TxDOT	CK: TxDOT
© TxDOT February 1998	CONT SECT:	JOB:	HIGHWAY:	
8-12 REVISIONS	644015	001	IH 20 ETC.	
	DIST:	COUNTY:	SHEET NO.:	
	02	PALO PINTO	21	

DISCLAIMER: This standard is governed by the "Texas Engineering Practice Act". No warranty of any kind is made by TxDOT for any purpose whatsoever. TxDOT assumes no responsibility for the conversion of this standard to other formats or for incorrect results or damages resulting from its use.

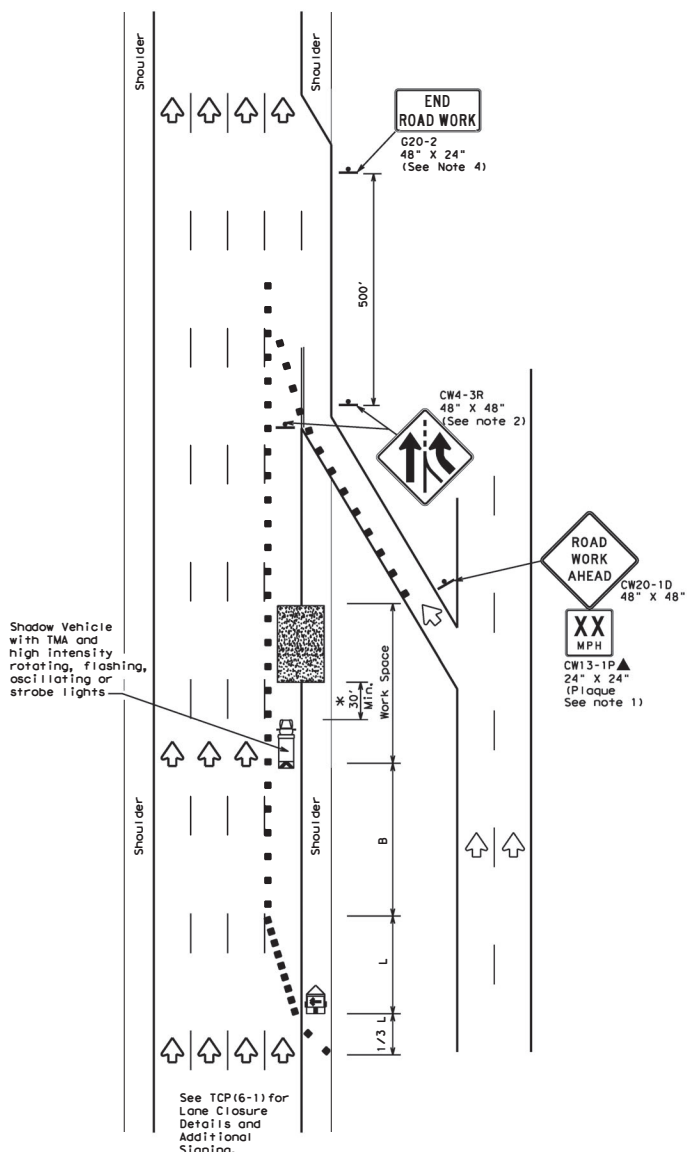

TCP (6-2a)  
**ENTRANCE RAMP OPEN**  
**WORK WITHIN 500' OF RAMP**

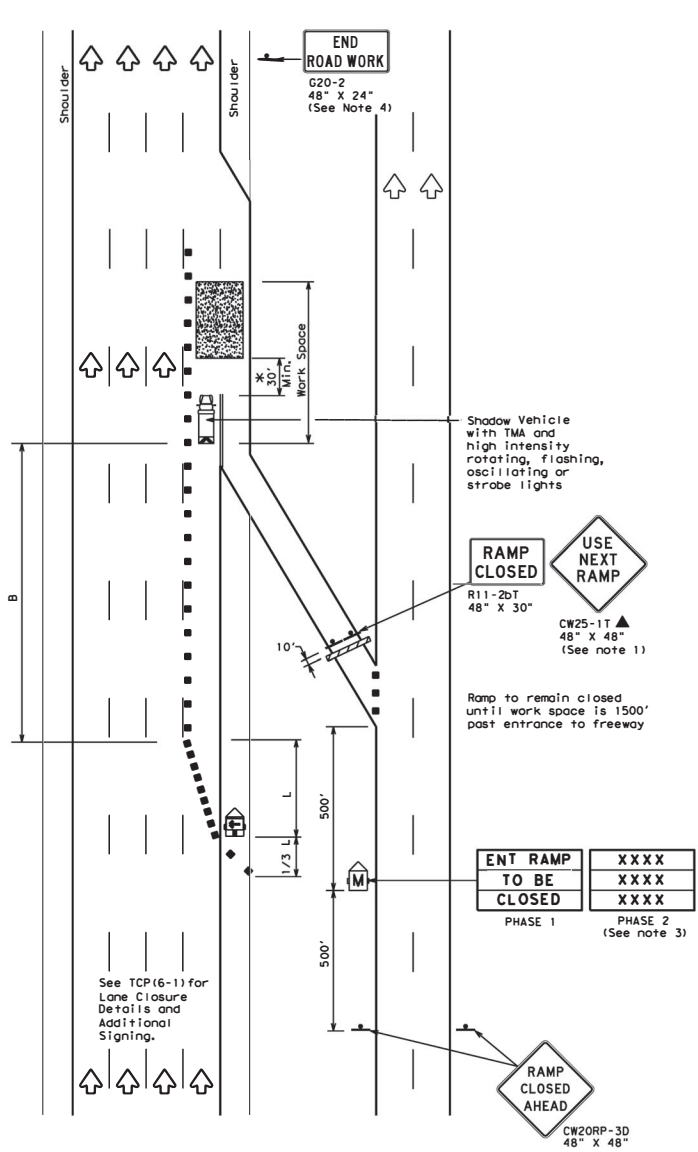

TCP (6-2b)  
**ENTRANCE RAMP CLOSED**

LEGEND			
	Type 3 Barricade		Channelizing Devices
	Heavy Work Vehicle		Truck Mounted Attenuator (TMA)
	Trailer Mounted Flashing Arrow Board		Portable Changeable Message Sign (PCMS)
	Sign		Traffic Flow
	Flag		Flagger

Posted Speed	Formula	Minimum Desirable Taper Lengths "L"			Suggested Maximum Spacing of Channelizing Devices		Suggested Longitudinal Buffer Space "B"
		10' Offset	11' Offset	12' Offset	On a Taper	On a Tangent	
45	L = WS	450'	495'	540'	45'	90'	195'
50		500'	550'	600'	50'	100'	240'
55		550'	605'	660'	55'	110'	295'
60		600'	660'	720'	60'	120'	350'
65		650'	715'	780'	65'	130'	410'
70		700'	770'	840'	70'	140'	475'
75		750'	825'	900'	75'	150'	540'
80		800'	880'	960'	80'	160'	615'

\*\*Taper lengths have been rounded off.  
L=Length of Taper(FT) W=Width of Offset(FT) S=Posted Speed(MPH)

TYPICAL USAGE				
MOBILE	SHORT DURATION	SHORT TERM STATIONARY	INTERMEDIATE TERM STATIONARY	LONG TERM STATIONARY
	✓	✓	✓	

- GENERAL NOTES**
- All traffic control devices illustrated are REQUIRED. Devices denoted with the triangle symbol may be omitted when stated elsewhere in the plans.
  - ADDED LANE SYMBOL (CW4-3) sign may be omitted when sign between ramp and mainline can be seen from both roadways.
  - See "Advance Notice List" on BC(6) for recommended date and time formatting options for POMS Phase 2 message.
  - The END ROAD WORK (G20-2) sign may be omitted when it conflicts with G20-2 signs already in place on the project.

\*A shadow vehicle equipped with a Truck Mounted Attenuator is typically required. A shadow vehicle equipped with a TMA shall be used if it can be positioned 30' to 100' in advance of the area of crew exposure without adversely affecting the work performance.

Additional requirements for lane closures and advance signing shall be as shown on TCP (6-1) or as directed by the Engineer.



**TRAFFIC CONTROL PLAN**  
**WORK AREA NEAR RAMP**

**TCP (6-2) - 12**

FILES: tcp6-2.dgn	DN: TxDOT	CR: TxDOT	DN: TxDOT	CR: TxDOT
© TxDOT February 1994	CONT: 6440	SECT: 15	JOB: 001	PROJECT: IH 20 ETC.
REVISIONS:	DATE:	BY:	COUNTY:	SHEET NO.:
1-97 8-98	4-98 8-12	02	PALO PINTO	22

DATE: FILE:

DISCLAIMER: This standard is governed by the "Texas Engineering Practice Act". No warranty of any kind is made by TxDOT for any purpose whatsoever. TxDOT assumes no responsibility for the conversion of this standard to other formats or for incorrect results or damages resulting from its use.

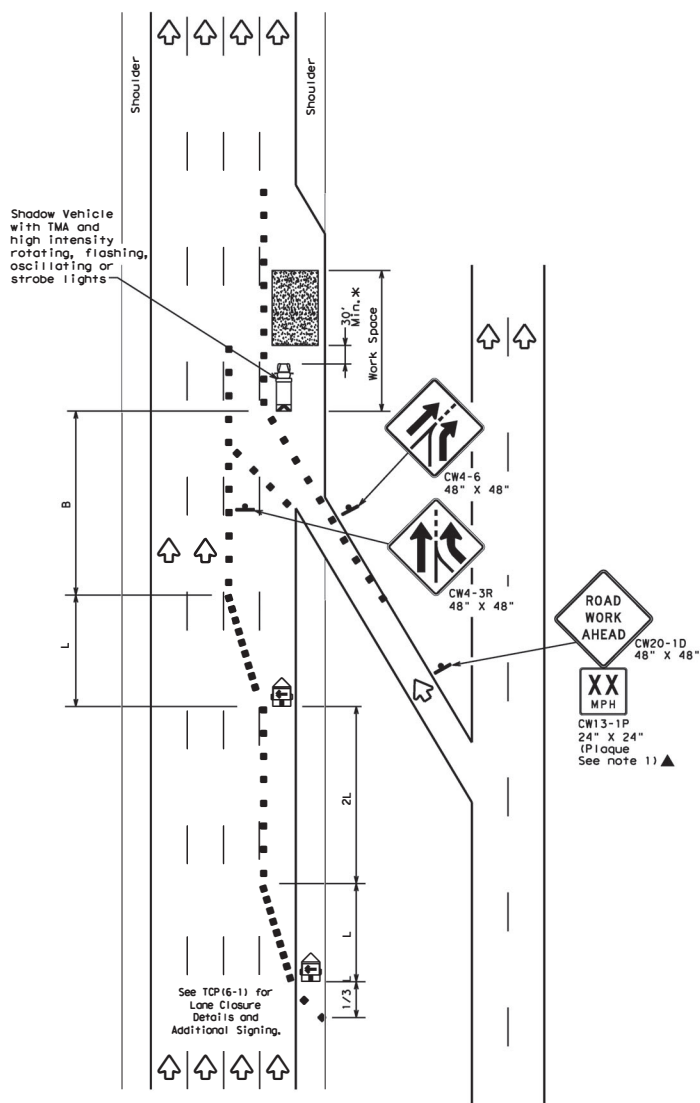

TCP (6-3a)  
ENTRANCE RAMP OPEN

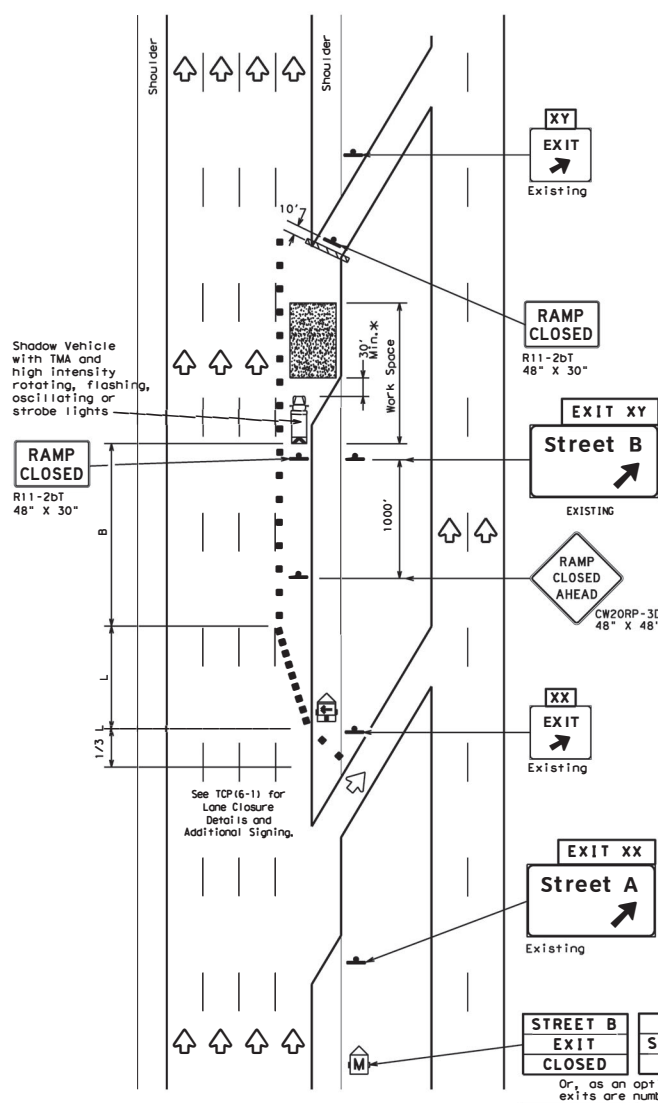

TCP (6-3b)  
EXIT RAMP CLOSED  
TRAFFIC EXITS PRIOR TO CLOSED RAMP

LEGEND			
	Type 3 Barricade		Channelizing Devices
	Heavy Work Vehicle		Truck Mounted Attenuator (TMA)
	Trailer Mounted Flashing Arrow Board		Portable Changeable Message Sign (PCMS)
	Sign		Traffic Flow
	Flag		Flagger

Posted Speed	Formula	Minimum Desirable Taper Lengths "L"			Suggested Maximum Spacing of Channelizing Devices		Suggested Longitudinal Buffer Space "B"
		10' Offset	11' Offset	12' Offset	On a Taper	On a Tangent	
45	L = WS	450'	495'	540'	45'	90'	195'
50		500'	550'	600'	50'	100'	240'
55		550'	605'	660'	55'	110'	295'
60		600'	660'	720'	60'	120'	350'
65		650'	715'	780'	65'	130'	410'
70		700'	770'	840'	70'	140'	475'
75		750'	825'	900'	75'	150'	540'
80		800'	880'	960'	80'	160'	615'

\*\* Taper lengths have been rounded off.  
L- Length of Taper (FT) W- Width of Offset (FT) S- Posted Speed (MPH)

TYPICAL USAGE				
MOBILE	SHORT DURATION	SHORT TERM STATIONARY	INTERMEDIATE TERM STATIONARY	LONG TERM STATIONARY
	✓	✓	✓	

GENERAL NOTES:

- All traffic control devices illustrated are REQUIRED. Devices denoted with the triangle symbol may be omitted when stated elsewhere in the plans.

\*A shadow vehicle equipped with a Truck Mounted Attenuator is typically required. A shadow vehicle equipped with a TMA shall be used if it can be positioned 30' to 100' in advance of the area of crew exposure without adversely affecting the work performance.

Additional requirements for lane closures and advance signing shall be as shown on TCP (6-1) or as directed by the Engineer.

STREET B EXIT CLOSED	USE STREET A EXIT
EXIT XY CLOSED	USE EXIT XX

Or, as an option when exits are numbered

Place 1 mile (approx.)  
in advance of Street A  
exit.



TRAFFIC CONTROL PLAN  
WORK AREA BEYOND RAMP

TCP (6-3) - 12

FILE: tcp6-3.dgn	DN: TxDOT	CK: TxDOT	DN: TxDOT	CK: TxDOT
© TxDOT February 1994	CONT: 6440	SECT: 15	JOB: 001	HIGHWAY: IH 20 ETC.
1-91 8-98	REV: 01ST	COUNTY:	CITY:	SHEET NO.:
4-98 8-12	02	PALO PINTO		23

DATE:  
FILE:

DISCLAIMER: The use of this standard is governed by the "Texas Engineering Practice Act". No warranty of any kind is made by the author or publisher for the use of this standard or for incorrect results or damages resulting from its use.

DATE: FILE:

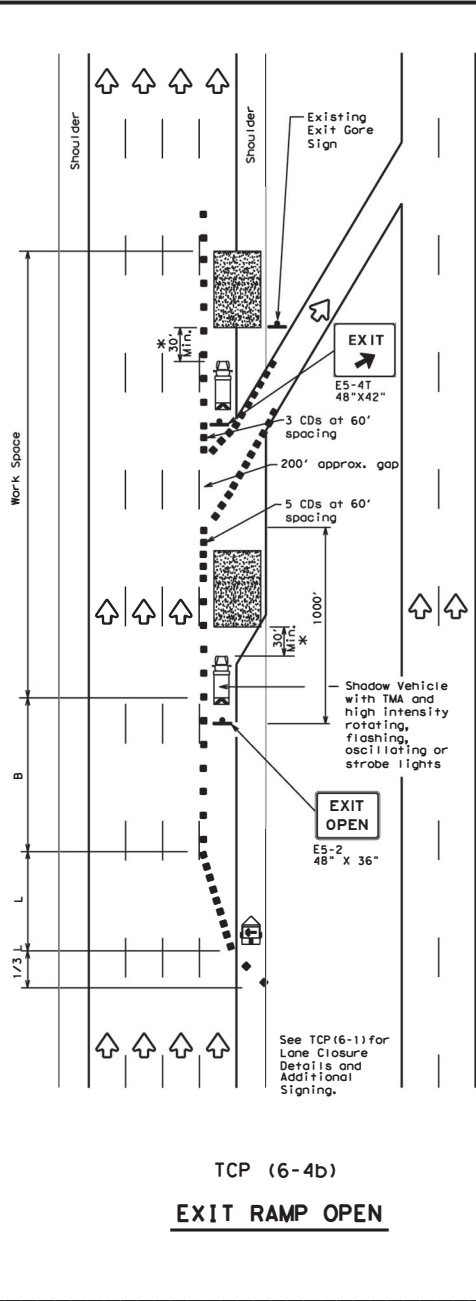
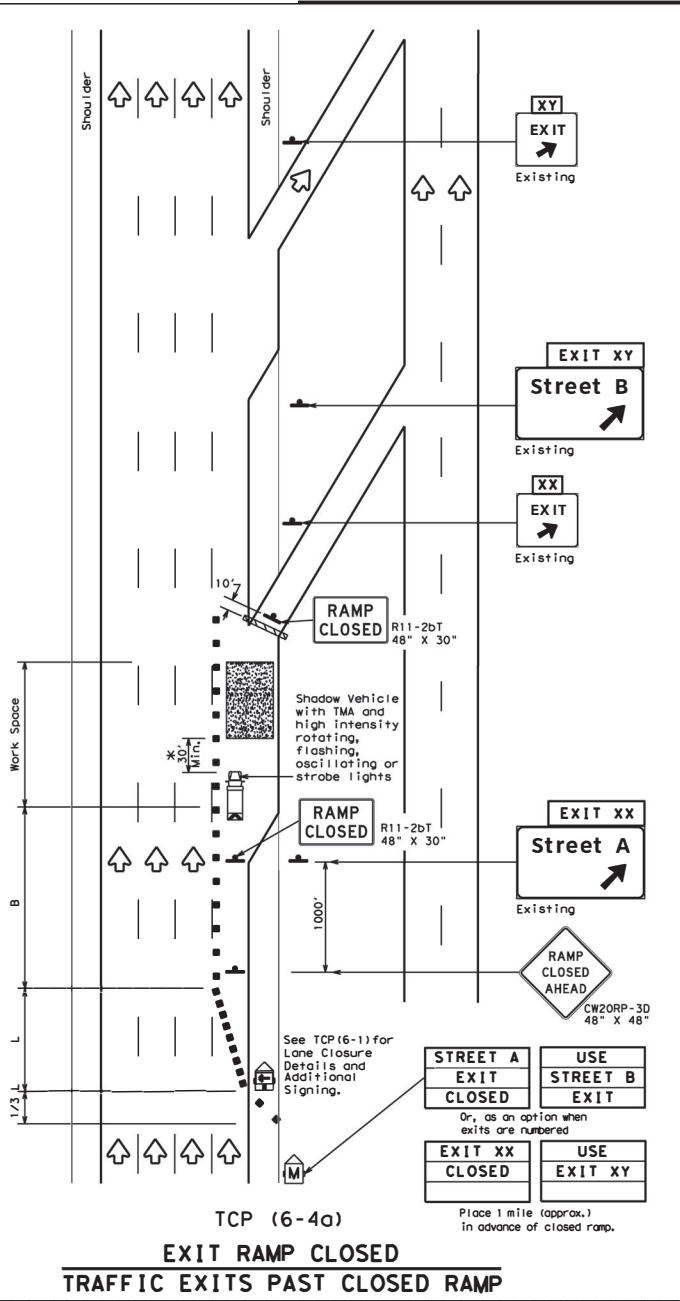

**LEGEND**

	Type 3 Barricade		Channelizing Devices (CDs)
	Heavy Work Vehicle		Truck Mounted Attenuator (TMA)
	Trailer Mounted Flashing Arrow Board		Portable Changeable Message Sign (PCMS)
	Sign		Traffic Flow
	Flag		Flagger

Posted Speed	Formula	Minimum Desirable Taper Lengths "L"			Suggested Maximum Spacing of Channelizing Devices		Suggested Longitudinal Buffer Space "B"
		10' Offset	11' Offset	12' Offset	On a Taper	On a Tangent	
45	L = WS	450'	495'	540'	45'	90'	195'
50		500'	550'	600'	50'	100'	240'
55		550'	605'	660'	55'	110'	295'
60		600'	660'	720'	60'	120'	350'
65		650'	715'	780'	65'	130'	410'
70		700'	770'	840'	70'	140'	475'
75		750'	825'	900'	75'	150'	540'
80		800'	880'	960'	80'	160'	615'

\*\*Taper lengths have been rounded off.  
 L=Length of Taper (FT) W=Width of Offset (FT) S=Posted Speed (MPH)

**TYPICAL USAGE**

MOBILE	SHORT DURATION	SHORT TERM STATIONARY	INTERMEDIATE TERM STATIONARY	LONG TERM STATIONARY
	✓	✓	✓	

- GENERAL NOTES**
- All traffic control devices illustrated are REQUIRED. Devices denoted with the triangle symbol may be omitted when stated elsewhere in the plans.
  - See BC Standards for sign details.

\*A shadow vehicle equipped with a Truck Mounted Attenuator is typically required. A shadow vehicle equipped with a TMA shall be used if it can be positioned 30' to 100' in advance of the area of crew exposure without adversely affecting the work performance.

Additional requirements for lane closures and advance signing shall be as shown on TCP (6-1) or as directed by the Engineer.



**TRAFFIC CONTROL PLAN**  
**WORK AREA AT EXIT RAMP**

**TCP (6-4) - 12**

FILES: tcp6-4.dgn	DW: TXDOT	CHK: TXDOT	DW: TXDOT	CHK: TXDOT
© TXDOT February 1994	CONT: 6440	SECT: 15	JOB: 001	HIGHWAY: IH 20 ETC.
REVISIONS:	0151	02	COUNTY: PALO PINTO	SHEET NO.: 24

DISCLAIMER: The use of this standard is governed by the "Texas Engineering Practice Act". No warranty of any kind is made by TxDOT for any purpose whatsoever. TxDOT assumes no responsibility for the conversion of this standard to other formats or for incorrect results or damages resulting from its use.

DATE: FILE:

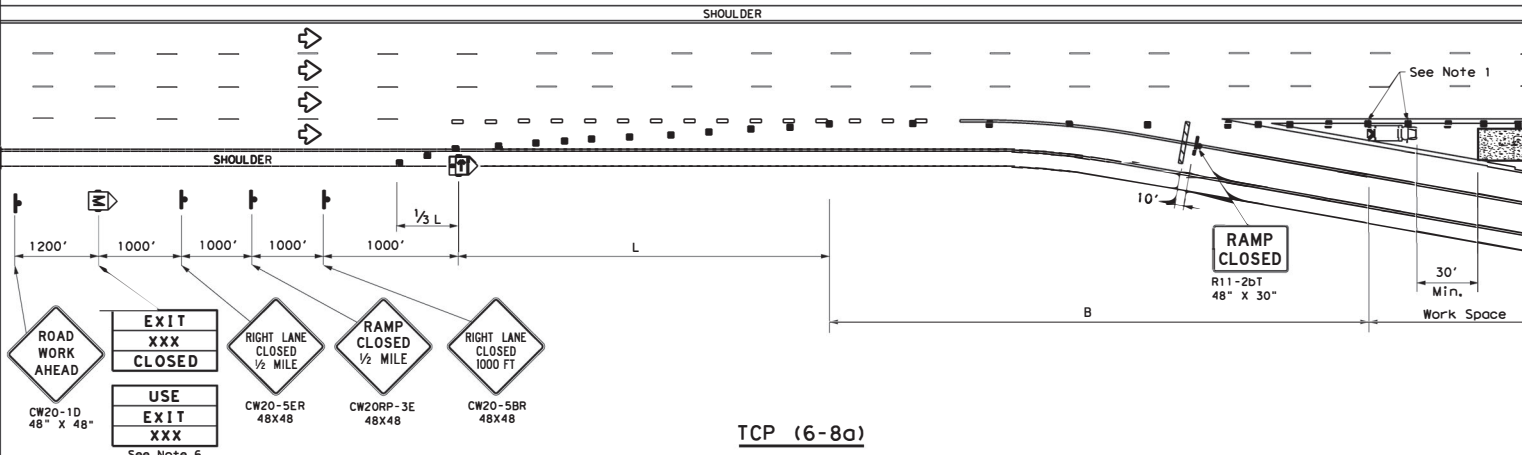

TCP (6-8a)

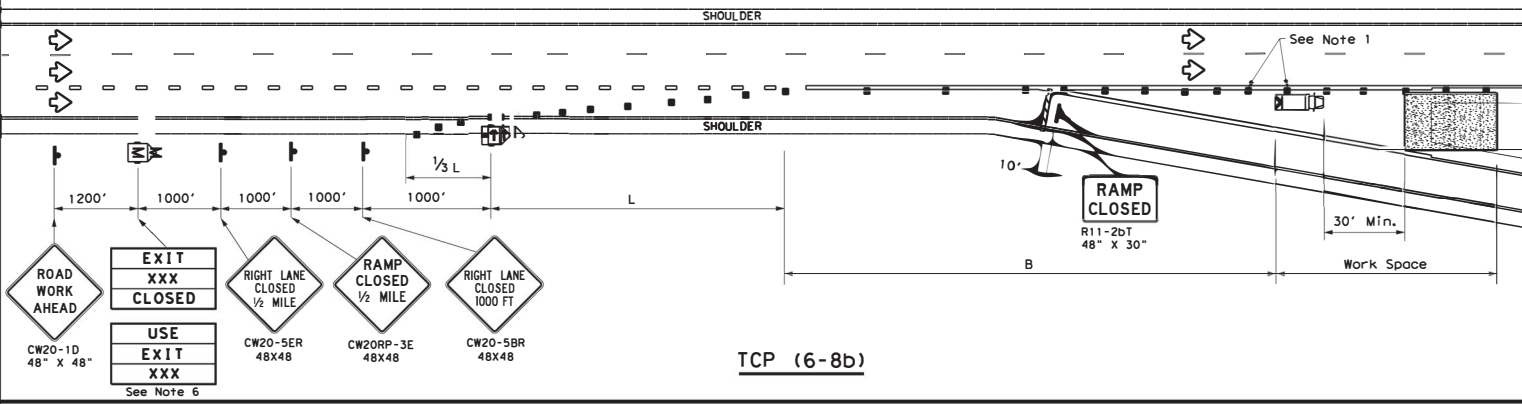

TCP (6-8b)

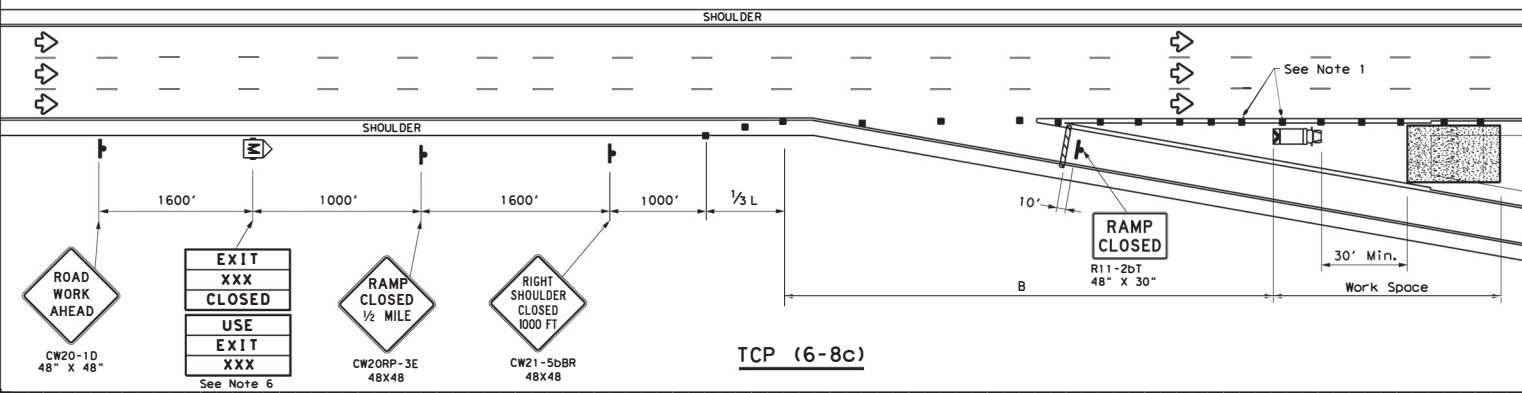

TCP (6-8c)

LEGEND			
	Type 3 Barricade		Channelizing Devices (CDs)
	Heavy Work Vehicle		Truck Mounted Attenuator (TMA)
	Trailer Mounted Flashing Arrow Board		Portable Changeable Message Sign (PCMS)
	Sign		Traffic Flow
	Flag		Flagger

Posted Speed	Formula	Minimum Desirable Taper Lengths "L" *X*			Suggested Maximum Spacing of Channelizing Devices		Suggested Longitudinal Buffer Space "b"
		10' Offset	11' Offset	12' Offset	On a Taper	On a Tangent	
45	L = WS	450'	495'	540'	45'	90'	195'
50		500'	550'	600'	50'	100'	240'
55		550'	605'	660'	55'	110'	295'
60		600'	660'	720'	60'	120'	350'
65		650'	715'	780'	65'	130'	410'
70		700'	770'	840'	70'	140'	475'
75		750'	825'	900'	75'	150'	540'
80		800'	880'	960'	80'	160'	615'

\*\*X\* Taper lengths have been rounded off.  
 L=Length of Taper (FT) W=Width of Offset (FT)  
 S=Posted Speed (MPH)

TYPICAL USAGE				
MOBILE	SHORT DURATION	SHORT TERM STATIONARY	INTERMEDIATE TERM STATIONARY	LONG TERM STATIONARY
	✓	✓		

- GENERAL NOTES**
- Place channelizing devices in the gore at 20' spacing.
  - See the Standard Highway Sign Design for Texas (SHSD) for sign details.
  - The PCMS may be omitted when a permanent DMS sign is available in an appropriate location to display a similar message as called for on the PCMS.
  - When it is determined that a through lane should be closed in addition to the exit ramp, refer to TCP(6-4) for traffic control details.
  - Truck mounted attenuator is required.
  - The PCMS may be omitted if replaced with a "RAMP CLOSED" AHEAD (CW2ORP-3D) Sign.
  - Roadway ADT should be greater than 10,000.



**WORK IN EXIT GORE FOR ADT GREATER THAN 10,000**

**TCP (6-8) - 14**

FILES	tcp6-8.dgn	DATE	TxDOT	CHK	TxDOT	DATE	TxDOT	CHK	TxDOT
CONT	February 2014	CONT	6440	SECT	15	JOB	001	DATE	1H 20 ETC.
REV	2-14	REV	01ST	COUNTY		CITY		SHEET NO.	
			02	COUNTY		CITY	PALO PINTO	SHEET NO.	25



DISCLAIMER: This standard is governed by the "Texas Engineering Practice Act". No warranty of any kind is made by TxDOT for any purpose whatsoever. TxDOT assumes no responsibility for the conversion of this standard to other formats or for incorrect results or damages resulting from its use.

DATE: DATE TIME  
FILE: DOCUMENT NAME

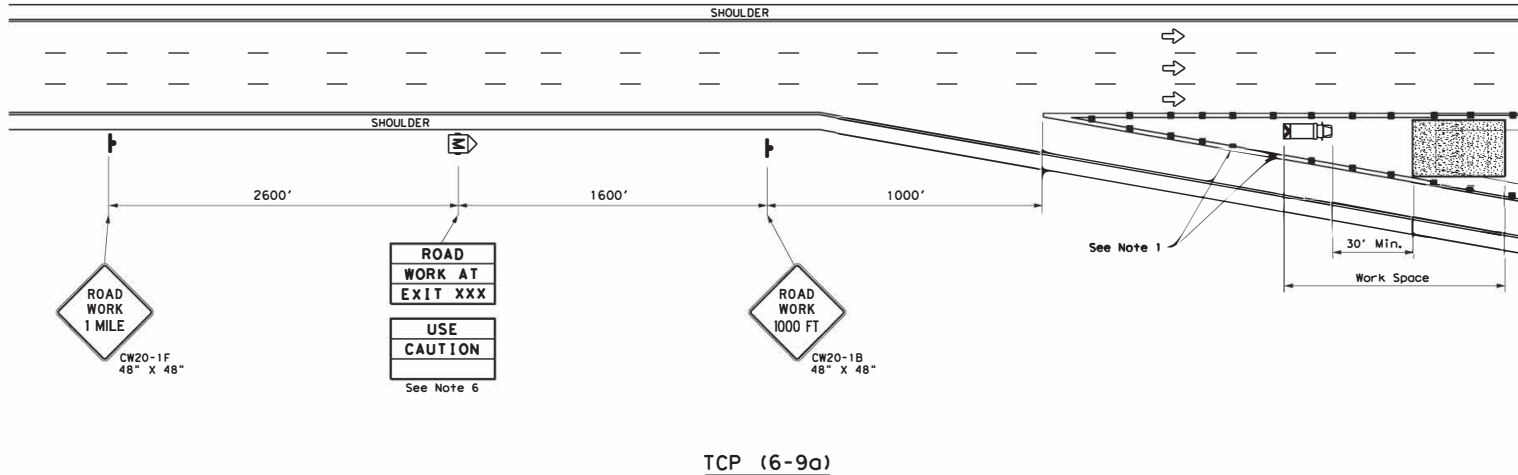

TCP (6-9a)

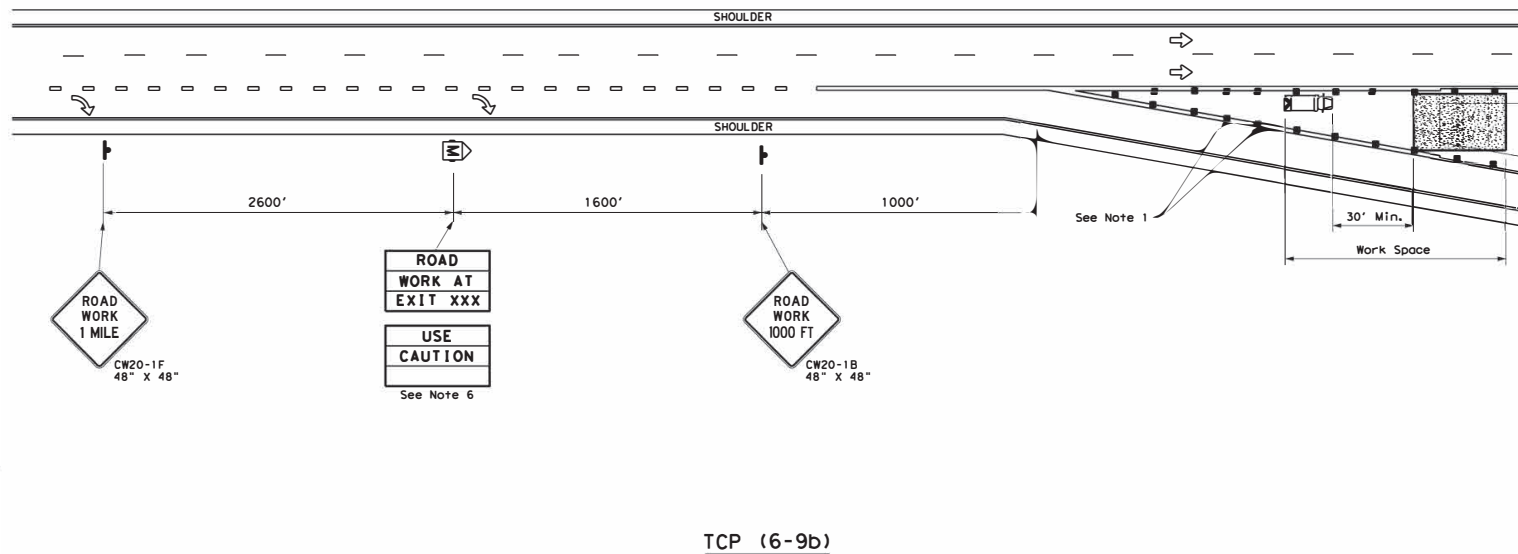

TCP (6-9b)

LEGEND			
	Type 3 Barricade		Channelizing Devices (CDs)
	Heavy Work Vehicle		Truck Mounted Attenuator (TMA)
	Trailer Mounted Flashing Arrow Board		Portable Changeable Message Sign (PCMS)
	Sign		Traffic Flow
	Flag		Flagger

Posted Speed	Formula	Minimum Desirable Taper Lengths "L" * * *			Suggested Maximum Spacing of Channelizing Devices		Suggested Longitudinal Buffer Space "B"
		10' Offset	11' Offset	12' Offset	On a Taper	On a Tangent	
45	L = WS	450'	495'	540'	45'	90'	195'
50		500'	550'	600'	50'	100'	240'
55		550'	605'	660'	55'	110'	295'
60		600'	660'	720'	60'	120'	350'
65		650'	715'	780'	65'	130'	410'
70		700'	770'	840'	70'	140'	475'
75		750'	825'	900'	75'	150'	540'
80		800'	880'	960'	80'	160'	615'

\* \* \* Taper lengths have been rounded off.  
L=Length of Taper (FT) W=Width of Offset (FT)  
S=Posted Speed (MPH)

TYPICAL USAGE				
MOBILE	SHORT DURATION	SHORT TERM STATIONARY	INTERMEDIATE TERM STATIONARY	LONG TERM STATIONARY
	✓	✓		

**GENERAL NOTES**

- Place channelizing devices in the gore at 20' spacing.
- See the Standard Highway Sign Design for Texas (SHSD) for sign details.
- The PCMS may be omitted when a permanent DMS sign is available in an appropriate location to display a similar message as called for on the PCMS.
- When it is determined that a through lane should be closed in addition to the exit ramp, refer to TCP (6-4) and TCP (6-8) for traffic control details.
- Truck mounted attenuators are required.
- The PCMS may be omitted if replaced with a "ROAD WORK 1/2 MILE" (CW20-1E).
- Roadway ADT should be less than 10,000.



**WORK IN EXIT GORE FOR ADT LESS THAN 10,000**

**TCP (6-9) - 14**

FILE: fcp6-9.dgn	DATE: TXDOT	CHK: TXDOT	APP: TXDOT	CHK: TXDOT
© TXDOT February 2014				
2-14	REVISIONS	6440	15	001
		02		
			02	
			PALO PINTO	
				26

DISCLAIMER: The use of this standard is governed by the "Texas Engineering Practice Act". No warranty of any kind is made by the Texas Department of Transportation for the use of this standard for any purpose other than that for which it was developed. The user assumes all liability for any damage resulting from its use.

DATE: FILE:

**BARRICADE AND CONSTRUCTION (BC) STANDARD SHEETS GENERAL NOTES:**

1. The Barricade and Construction Standard Sheets (BC sheets) are intended to show typical examples for placement of temporary traffic control devices, construction pavement markings, and typical work zone signs. The information contained in these sheets meet or exceed the requirements shown in the "Texas Manual on Uniform Traffic Control Devices" (TMUTCD).
2. The development and design of the Traffic Control Plan (TCP) is the responsibility of the Engineer.
3. The Contractor may propose changes to the TCP that are signed and sealed by a licensed professional engineer for approval. The Engineer may develop, sign and seal Contractor proposed changes.
4. The Contractor is responsible for installing and maintaining the traffic control devices as shown in the plans. The Contractor may not move or change the approximate location of any device without the approval of the Engineer.
5. Geometric design of lane shifts and detours should, when possible, meet the applicable design criteria contained in manuals such as the American Association of State Highway and Transportation Officials (AASHTO), "A Policy on Geometric Design of Highways and Streets," the TxDOT "Roadway Design Manual" or engineering judgment.
6. When projects abut, the Engineer(s) may omit the END ROAD WORK, TRAFFIC FINES DOUBLE, and other advance warning signs if the signing would be redundant and the work areas appear continuous to the motorists. If the adjacent project is completed first, the Contractor shall erect the necessary warning signs as shown on these sheets, the TCP sheets or as directed by the Engineer. The BEGIN ROAD WORK NEXT X MILES sign shall be revised to show appropriate work zone distance.
7. The Engineer may require duplicate warning signs on the median side of divided highways where median width will permit and traffic volumes justify the signing.
8. All signs shall be constructed in accordance with the details found in the "Standard Highway Sign Designs for Texas," latest edition. Sign details not shown in this manual shall be shown in the plans or the Engineer shall provide a detail to the Contractor before the sign is manufactured.
9. The temporary traffic control devices shown in the illustrations of the BC sheets are examples. As necessary, the Engineer will determine the most appropriate traffic control devices to be used.
10. Where highway construction or maintenance work is being undertaken, other than mobile operations as defined by the Texas Manual on Uniform Traffic Control Devices, CSJ limit signs are required. CSJ limit signs are shown on BC(2). The OBEY WARNING SIGNS STATE LAW sign, STAY ALERT TALK OR TEXT LATER and the WORK ZONE TRAFFIC FINES DOUBLE sign with plaque shall be erected in advance of the CSJ limits. The BEGIN ROAD WORK NEXT X MILES, CONTRACTOR and END ROAD WORK signs shall be erected at or near the CSJ limits. For mobile operations, CSJ limit signs are not required.
11. Traffic control devices should be in place only while work is actually in progress or a definite need exists.
12. The Engineer has the final decision on the location of all traffic control devices.
13. Inactive equipment and work vehicles, including workers' private vehicles must be parked away from travel lanes. They should be as close to the right-of-way line as possible, or located behind a barrier or guardrail, or as approved by the Engineer.

**WORKER SAFETY NOTES:**

1. Workers on foot who are exposed to traffic or to construction equipment within the right-of-way shall wear high-visibility safety apparel meeting the requirements of ISEA "American National Standard for High-Visibility Apparel," or equivalent revisions, and labeled as ANSI 107-2004 standard performance for Class 2 or 3 risk exposure. Class 3 garments should be considered for high traffic volume work areas or night time work.
2. Except in emergency situations, flagger stations shall be illuminated when flagging is used at night.

**COMPLIANT WORKZONE TRAFFIC CONTROL DEVICES**

1. Only pre-qualified products shall be used. The "Compliant Work Zone Traffic Control Devices List" (CWZTCD) describes pre-qualified products and their sources.
2. Work zone traffic control devices shall be compliant with the Manual for Assessing safety Hardware (MASH).

<p><b>THE DOCUMENTS BELOW CAN BE FOUND ON-LINE AT</b>  <a href="http://www.txdot.gov">http://www.txdot.gov</a></p>
COMPLIANT WORK ZONE TRAFFIC CONTROL DEVICES LIST (CWZTCD)
DEPARTMENTAL MATERIAL SPECIFICATIONS (DMS)
MATERIAL PRODUCER LIST (MPL)
ROADWAY DESIGN MANUAL - SEE "MANUALS (ONLINE MANUALS)"
STANDARD HIGHWAY SIGN DESIGNS FOR TEXAS (SHSD)
TEXAS MANUAL ON UNIFORM TRAFFIC CONTROL DEVICES (TMUTCD)
TRAFFIC ENGINEERING STANDARD SHEETS

SHEET 1 OF 12



**BARRICADE AND CONSTRUCTION  
 GENERAL NOTES  
 AND REQUIREMENTS**

**BC (1) - 21**

FILE: bc-21.dgn	DN: TxDOT	CK: TxDOT	DN: TxDOT	CK: TxDOT
© TxDOT November 2002	CONT	SECT	JOB	HIGHWAY
REVISIONS	B440	15	001	1H 20L, ETC.
4-03 7-13	DIST	COUNTY	SHEET NO.	
9-07 8-14	02	PALO PINTO	27	
5-10 5-21				

**TYPICAL LOCATION OF CROSSROAD SIGNS**

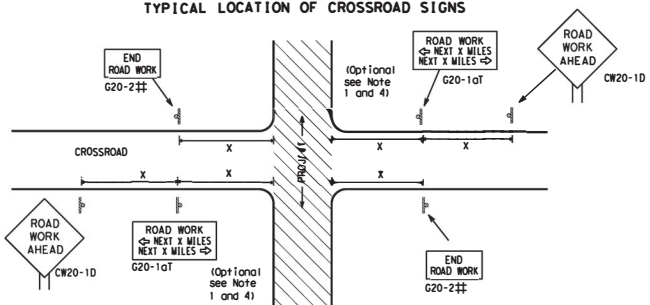

- ## May be mounted on back of "ROAD WORK AHEAD" (CW20-1D) sign with approval of Engineer. (See note 2 below)
- The typical minimum signing on a crossroad approach should be a "ROAD WORK AHEAD" (CW20-1D) sign and a (G20-2) "END ROAD WORK" sign, unless noted otherwise in plans.
  - The Engineer may use the reduced size 36" x 36" ROAD WORK AHEAD (CW20-1D) sign mounted back to back with the reduced size 36" x 18" "END ROAD WORK" (G20-2) sign on low volume crossroads (see Note 4 under "Typical Construction Warning Sign Size and Spacing"). See the "Standard Highway Sign Designs for Texas" manual for sign details. The Engineer may omit the advance warning signs on low volume crossroads. The Engineer will determine whether a road is low volume as per TMUTCD Part 5. This information shall be shown in the plans.
  - Based on existing field conditions, the Engineer/Inspector may require additional signs such as FLAGGER AHEAD, LOOSE GRAVEL, or other appropriate signs. When additional signs are required, these signs will be considered part of the minimum requirements. The Engineer/Inspector will determine the proper location and spacing of any sign not shown on the BC sheets, Traffic Control Plan sheets or the Work Zone Standard Sheets.
  - The "ROAD WORK NEXT X MILES" (G20-1a) sign shall be required at high volume crossroads to advise motorists of the length of construction in either direction from the intersection. The Engineer will determine whether a roadway is considered high volume.
  - Additional traffic control devices may be shown elsewhere in the plans for higher volume crossroads.
  - When work occurs in the intersection area, appropriate traffic control devices, as shown elsewhere in the plans or as determined by the Engineer/Inspector, shall be in place.

**T-INTERSECTION**

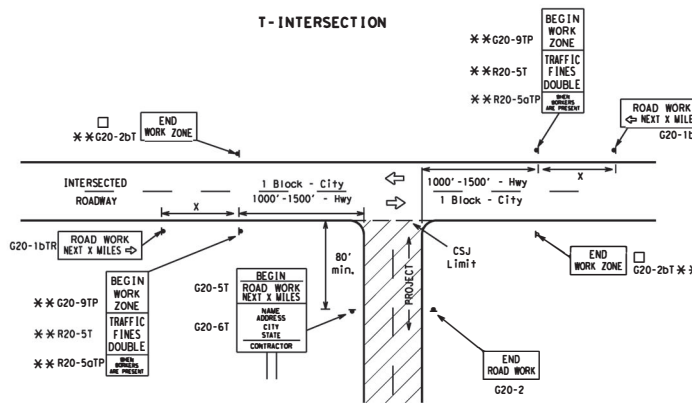

**CSJ LIMITS AT T-INTERSECTION**

- The Engineer will determine the types and location of any additional traffic control devices, such as a flagger and accompanying signs, or other signs, that should be used when work is being performed at or near an intersection.
- If construction closes the road at a T-intersection, the Contractor shall place the "CONTRACTOR NAME" (G20-6T) sign behind the Type 3 Barricades for the road closure (see BC(10) also). The "ROAD WORK NEXT X MILES" left arrow (G20-1bTL) and "ROAD WORK NEXT X MILES" right arrow (G20-1bTR) signs shall be replaced by the detour signing called for in the plans.

**TYPICAL CONSTRUCTION WARNING SIGN SIZE AND SPACING<sup>15,6</sup>**

Sign Number or Series	SIZE		SPACING	
	Conventional Road	Expressway/Freeway	Posted Speed	Sign Spacing "X"
CW20 <sup>4</sup>	48" x 48"	48" x 48"	MPH	Feet (Approx.)
CW21			30	120
CW22			35	160
CW23			40	240
CW25			45	320
CW1, CW2, CW7, CW8, CW9, CW11, CW14	36" x 36"	48" x 48"	50	400
			55	500 <sup>2</sup>
			60	600 <sup>2</sup>
			65	700 <sup>2</sup>
			70	800 <sup>2</sup>
CW3, CW4, CW5, CW6, CW8-3, CW10, CW12	48" x 48"	48" x 48"	75	900 <sup>2</sup>
			80	1000 <sup>2</sup>
			*	*

\* For typical sign spacings on divided highways, expressways and freeways, see Part 6 of the "Texas Manual on Uniform Traffic Control Devices" (TMUTCD) typical application diagrams or TCP Standard Sheets.

△ Minimum distance from work area to first Advance Warning sign nearest the work area and/or distance between each additional sign.

**GENERAL NOTES**

- Special or larger size signs may be used as necessary.
- Distance between signs should be increased as required to have 1500 feet advance warning.
- Distance between signs should be increased as required to have 1/2 mile or more advance warning.
- 36" x 36" "ROAD WORK AHEAD" (CW20-1D) signs may be used on low volume crossroads at the discretion of the Engineer as per TMUTCD Part 5. See Note 2 under "Typical Location of Crossroad Signs".
- Only diamond shaped warning sign sizes are indicated.
- See sign size listing in "TMUTCD", Sign Appendix or the "Standard Highway Sign Designs for Texas" manual for complete list of available sign design sizes.

**WORK AREAS IN MULTIPLE LOCATIONS WITHIN CSJ LIMITS**

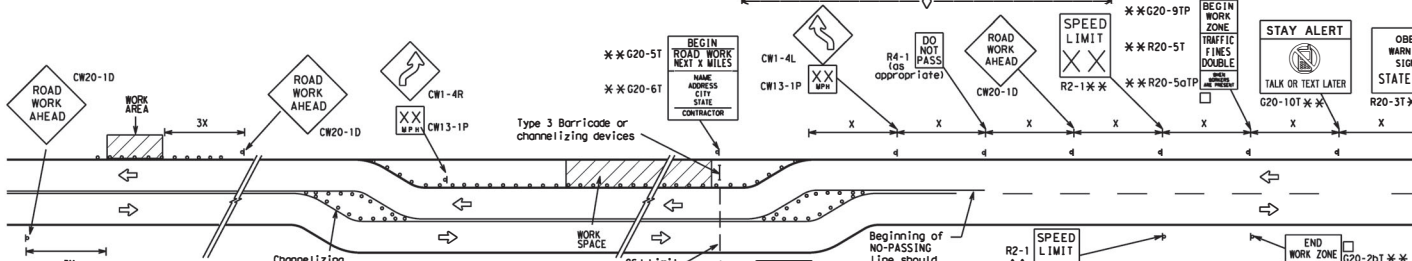

When extended distances occur between minimal work spaces, the Engineer/Inspector should ensure additional "ROAD WORK AHEAD" (CW20-1D) signs are placed in advance of these work areas to remind drivers they are still within the project limits. See the applicable TCP sheets for exact location and spacing of signs and channelizing devices.

**SAMPLE LAYOUT OF SIGNING FOR WORK BEGINNING DOWNSTREAM OF THE CSJ LIMITS**

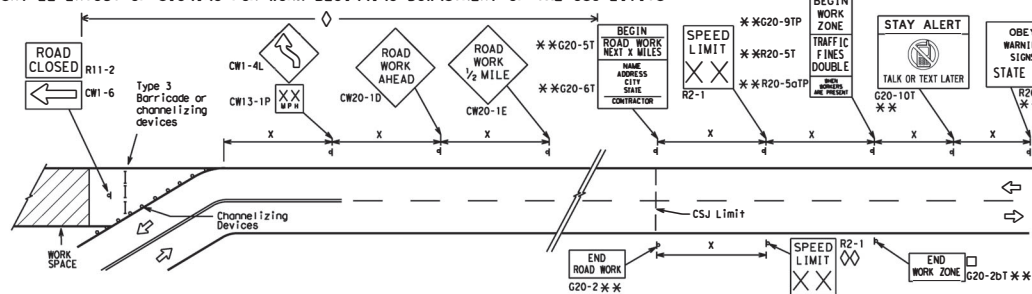

**NOTES**

The Contractor shall determine the appropriate distance to be placed on the G20-1 series signs and "BEGIN ROAD WORK NEXT X MILES" (G20-5T) sign for each specific project. This distance shall replace the "X" and shall be rounded to the nearest whole mile with the approval of the Engineer. No decimals shall be used.

- The "BEGIN WORK ZONE" (G20-9TP) and "END WORK ZONE" (G20-2bT) shall be used as shown on the sample layout when advance signs are required outside the CSJ Limits. They inform the motorist of entering or leaving a part of the work zone lying outside the CSJ Limits where traffic fines may double if workers are present.
- \*\* CSJ limit signing is required for highway construction and maintenance work, with the exception of mobile operations.
- ◇ Area for placement of "ROAD WORK AHEAD" (CW20-1D) sign and other signs or devices as called for on the Traffic Control Plan.
- ◇◇ Contractor will install a regulatory speed limit sign at the end of the work zone.

LEGEND	
—	Type 3 Barricade
○ ○ ○	Channelizing Devices
—	Sign
X	See Typical Construction Warning Sign Size and Spacing chart or the TMUTCD for sign spacing requirements.

SHEET 2 OF 12



**BARRICADE AND CONSTRUCTION PROJECT LIMIT**

**BC (2) - 21**

FILES: bc-21.dgn	DATE: 10/01/02	BY: TXDOT	CHK: TXDOT	DATE: 10/01/02	CHK: TXDOT
© TXDOT November 2002	REV: 15	JOB: 001	SECTION: 115	DATE: 9-07	DATE: 8-14
		COUNTY: 02	PROJECT: 7-13	DATE: 5-21	DATE: 5-21

DISCLAIMER: The use of this standard is governed by the Texas Engineering Practice Act. No warranty of any kind is made by the Texas Department of Transportation for any design or construction of this standard or for any damages resulting from its use.

DATE: FILE:

## TYPICAL APPLICATION OF WORK ZONE SPEED LIMIT SIGNS

Work zone speed limits shall be regulatory, established in accordance with the "Procedures for Establishing Speed Zones," and approved by the Texas Transportation Commission, or by City Ordinance when within Incorporated City Limits.

Reduced speeds should only be posted in the vicinity of work activity and not throughout the entire project. Regulatory work zone speed signs (R2-1) shall be removed or covered during periods when they are not needed.

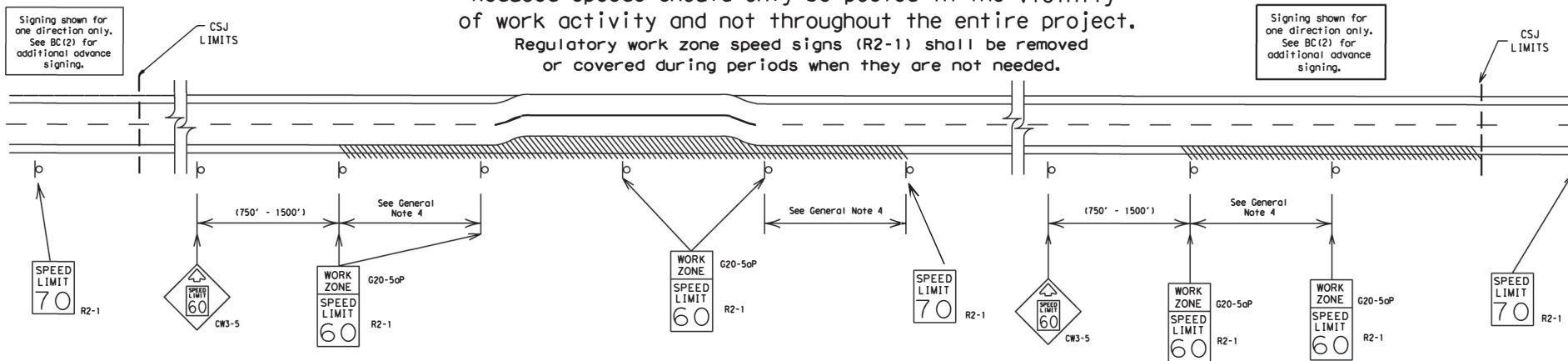

### GUIDANCE FOR USE:

#### LONG/INTERMEDIATE TERM WORK ZONE SPEED LIMITS

This type of work zone speed limit should be included on the design of the traffic control plans when restricted geometrics with a lower design speed are present in the work zone and modification of the geometrics to a higher design speed is not feasible.

Long/Intermediate Term Work Zone Speed Limit signs, when approved as described above, should be posted and visible to the motorist when work activity is present.

Work activity may also be defined as a change in the roadway that requires a reduced speed for motorists to safely negotiate the work area, including:

- a) rough road or damaged pavement surface
- b) substantial alteration of roadway geometrics (diversions)
- c) construction detours
- d) grade
- e) width
- f) other conditions readily apparent to the driver

As long as any of these conditions exist, the work zone speed limit signs should remain in place.

#### SHORT TERM WORK ZONE SPEED LIMITS

This type of work zone speed limit may be included on the design of the traffic control plans when workers or equipment are not behind concrete barrier, when work activity is within 10 feet of the traveled way or actually in the traveled way.

Short Term Work Zone Speed Limit signs should be posted and visible to the motorists only when work activity is present. When work activity is not present, signs shall be removed or covered. (See Removing or Covering on BC(4)).

#### GENERAL NOTES

1. Regulatory work zone speed limits should be used only for sections of construction projects where speed control is of major importance.
2. Regulatory work zone speed limit signs shall be placed on supports at a 7 foot minimum mounting height.
3. Speed zone signs are illustrated for one direction of travel and are normally posted for each direction of travel.
4. Frequency of work zone speed limit signs should be:  
 40 mph and greater    0.2 to 2 miles  
 35 mph and less        0.2 to 1 mile
5. Regulatory speed limit signs shall have black legend and border on a white reflective background (See "Reflective Sheeting" on BC(4)).
6. Fabrication, erection and maintenance of the "ADVANCE SPEED LIMIT" (CW3-5) sign, "WORK ZONE" (G20-5aP) plaque and the "SPEED LIMIT" (R2-1) signs shall not be paid for directly, but shall be considered subsidiary to Item 502.
7. Turning signs from view, laying signs over or down will not be allowed, unless as otherwise noted under "REMOVING OR COVERING" on BC(4).
8. Techniques that may help reduce traffic speeds include but are not limited to:  
 A. Law enforcement.  
 B. Flagger stationed next to sign.  
 C. Portable changeable message sign (PCMS).  
 D. Low-power (drone) radar transmitter.  
 E. Speed monitor trailers or signs.
9. Signs shown on details above are for illustration only. Work Zone Speed Limits should only be posted as approved for each project.
10. For more specific guidance concerning the type of work, work zone conditions and factors impacting allowable regulatory construction speed zone reduction see TxDOT form #1204 in the TxDOT e-form system.

DISCLAIMER: The use of this standard is governed by the "Texas Engineering Practice Act". No warranty of any kind is made by TxDOT for any purpose whatsoever. TxDOT assumes no responsibility for the conversion of this standard to other formats or for incorrect results or damages resulting from its use.

DATE: FILE:

SHEET 3 OF 12



Traffic Safety Division Standard

## BARRICADE AND CONSTRUCTION WORK ZONE SPEED LIMIT

### BC (3) - 21

FILE#	bc-21.dgn	DATE TxDOT	BY TxDOT	DATE TxDOT	BY TxDOT
© TxDOT	November 2002	CON#	SECT#	JOB	HIGHWAY
REVISIONS		6440	15	001	IN 20, ETC.
9-07 8-14		DIST		COUNTY	SHEET NO.
7-13 5-21		02		FALGOUT	29

**TYPICAL MINIMUM CLEARANCES FOR LONG TERM AND INTERMEDIATE TERM SIGNS**

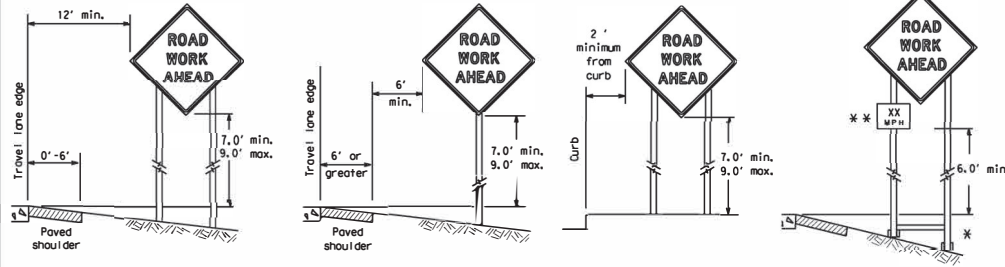

\* When placing skid supports on uneven ground, the leg post lengths must be adjusted so the sign appears straight and plumb. Objects shall NOT be placed under skids as a means of leveling.

\* \* \* When plaques are placed on dual-leg supports, they should be attached to the upright nearest the travel lane. Supplemental plaques (advisory or distance) should not cover the surface of the parent sign.

**ATTACHMENT FOR SIGN SUPPORTS**

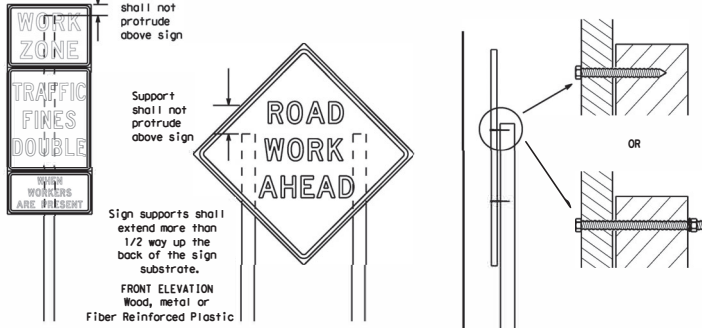

Attachment to wooden supports will be by bolts and nuts or screws. Use 1x20's or manufacturer's recommended procedures for attaching sign substrates to other types of sign supports

**Nails shall NOT be allowed.**  
Each sign shall be attached directly to the sign support. Multiple signs shall not be joined or spliced by any means. Wood supports shall not be extended or repaired by splicing or other means.

Splicing embedded perforated square metal tubing in order to extend post height will only be allowed when the splice is made using four bolts, two above and two below the splice point. Splice must be located entirely behind the sign substrate, not near the base of the support. Splice insert lengths should be at least 5 times nominal post size, centered on the splice and of at least the same gauge material.

**STOP/SLOW PADDLES**

1. STOP/SLOW paddles are the primary method to control traffic by flaggers. The STOP/SLOW paddle size should be 24" x 24".
2. STOP/SLOW paddles shall be retroreflectorized when used at night.
3. STOP/SLOW paddles may be attached to a staff with a minimum length of 6' to the bottom of the sign.
4. Any lights incorporated into the STOP or SLOW paddle faces shall only be as specifically described in Section 6E.03 Hand Signaling Devices in the TMCUCD.

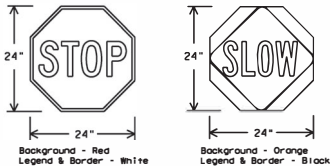

SHEETING REQUIREMENTS (WHEN USED AT NIGHT)		
USAGE	COLOR	SIGN FACE MATERIAL
BACKGROUND	RED	TYPE B OR C SHEETING
BACKGROUND	ORANGE	TYPE B <sub>TL</sub> OR C <sub>TL</sub> SHEETING
LEGEND & BORDER	WHITE	TYPE B OR C SHEETING
LEGEND & BORDER	BLACK	ACRYLIC NON-REFLECTIVE FILM

**CONTRACTOR REQUIREMENTS FOR MAINTAINING PERMANENT SIGNS WITHIN THE PROJECT LIMITS**

1. Permanent signs are used to give notice of traffic laws or regulations, call attention to conditions that are potentially hazardous to traffic operations, show route designations, destinations, directions, distances, services, points of interest, and other geographical, recreational, specific service (LOOO), or cultural information. Drivers proceeding through a work zone need the same, if not better route guidance as normally installed on a roadway without construction.
2. When permanent regulatory or warning signs conflict with work zone conditions, remove or cover the permanent signs until the permanent sign message matches the roadway condition. For details for covering large guide signs see the TS-CD standard.
3. When existing permanent signs are moved and relocated due to construction purposes, they shall be visible to motorists at all times.
4. If existing signs are to be relocated on their original supports, they shall be installed on crashworthy bases as shown on the SMD Standard sheets. The signs shall meet the required mounting heights shown on the BC Sheets or the SMD Standards. This work should be paid for under the appropriate pay item for relocating existing signs.
5. If permanent signs are to be removed and relocated using temporary supports, the Contractor shall use crashworthy supports as shown on the BC standard sheets, TLRs standard sheets or the CWTCD list. The signs shall meet the required mounting heights shown on the BC, or the SMD standard sheets during construction. This work should be paid for under the appropriate pay item for relocating existing signs.
6. Any sign or traffic control device that is struck or damaged by the Contractor or his/her construction equipment shall be replaced as soon as possible by the Contractor to ensure proper guidance for the motorists. This will be subsidiary to Item 502.

**GENERAL NOTES FOR WORK ZONE SIGNS**

1. Contractor shall install and maintain signs in a straight and plumb condition and/or as directed by the Engineer.
2. Wooden sign posts shall be painted white.
3. Barricades shall NOT be used as sign supports.
4. All signs shall be installed in accordance with the plans or as directed by the Engineer. Signs shall be used to regulate, warn, and guide the traveling public safely through the work zone.
5. The Contractor may furnish either the sign design shown in the plans or in the "Standard Highway Sign Designs for Texas" (SHSD). The Engineer/Inspector may require the Contractor to furnish other work zone signs that are shown in the TMCUCD but may have been omitted from the plans. Any variation in the plans shall be documented by written agreement between the Engineer and the Contractor's Responsible Person. All changes must be documented in writing before being implemented. This can include documenting the change in the Inspector's 1x20T diary and having both the Inspector and Contractor initial and date the agreed upon changes.
6. The Contractor shall furnish sign supports listed in the "Compliant Work Zone Traffic Control Device List" (CWTCD) for small roadside signs. Supports for temporary large roadside signs shall meet the requirements detailed on the Temporary Large Roadside Signs (TLRS) standard sheets. The Contractor shall install the sign support in accordance with the manufacturer's recommendations. If there is a question regarding installation procedures, the Contractor shall furnish the Engineer a copy of the manufacturer's installation recommendations so the Engineer can verify the correct procedures are being followed.
7. The Contractor is responsible for installing signs on approved supports and replacing signs with damaged or cracked substrates and/or damaged or marred reflective sheeting as directed by the Engineer/Inspector.
8. Identification markings may be shown only on the back of the sign substrate. The maximum height of letters and/or company logos used for identification shall be 1 inch.
9. The Contractor shall replace damaged wood posts. New or damaged wood sign posts shall not be spliced.

**DURATION OF WORK (as defined by the "Texas Manual on Uniform Traffic Control Devices" Part 6)**

1. The types of sign supports, sign mounting height, the size of signs, and the type of sign substrates can vary based on the type of work being performed. The Engineer is responsible for selecting the appropriate size sign for the type of work being performed. The Contractor is responsible for ensuring the sign support, sign mounting height and substrate meets manufacturer's recommendations in regard to crashworthiness and duration of work requirements.
  - a. Long-term stationary - work that occupies a location more than 3 days.
  - b. Intermediate-term stationary - work that occupies a location more than one daylight period up to 3 days, or nighttime work lasting more than one hour.
  - c. Short-term stationary - daytime work that occupies a location for more than 1 hour in a single daylight period.
  - d. Short, duration - work that occupies a location up to 1 hour.
  - e. Mobile - work that moves continuously or intermittently (stopping for up to approximately 15 minutes.)

**SIGN MOUNTING HEIGHT**

1. The bottom of Long-term/Intermediate-term signs shall be at least 7 feet, but not more than 9 feet, above the paved surface, except as shown for supplemental signs mounted below other signs.
2. The bottom of Short-term/Short Duration signs shall be a minimum of 1 foot above the pavement surface but no more than 2 feet above the ground.
3. Long-term/Intermediate-term signs may be used in lieu of Short-term/Short Duration signing.
4. Short-term/Short Duration signs shall be used only during daylight and shall be removed at the end of the workday or raised to appropriate Long-term/Intermediate sign height.
5. Regulatory signs shall be mounted at least 7 feet, but not more than 9 feet, above the paved surface regardless of work duration.

**SIZE OF SIGNS**

1. The Contractor shall furnish the sign sizes shown on BC (2) unless otherwise shown in the plans or as directed by the Engineer.

**SIGN SUBSTRATES**

1. The Contractor shall ensure the sign substrate is installed in accordance with the manufacturer's recommendations for the type of sign support that is being used. The CWTCD lists each substrate that can be used on the different types and models of sign supports.
2. "Mesh" type materials are NOT an approved sign substrate, regardless of the tightness of the weave.
3. All wooden individual sign panels fabricated from 2 or more pieces shall have one or more plywood cleat, 1/2" thick by 6" wide, fastened to the back of the sign and extending fully across the sign. The cleat shall be attached to the back of the sign using wood screws that do not penetrate the face of the sign panel. The screws shall be placed on both sides of the splice and spaced at 6" centers. The Engineer may approve other methods of splicing the sign face.

**REFLECTIVE SHEETING**

1. All signs shall be retroreflective and constructed of sheeting meeting the color and retro-reflectivity requirements of DMS-8300 for rigid signs or DMS-8310 for roll-up signs. The web address for DMS specifications is shown on BC(1).
2. White sheeting, meeting the requirements of DMS-8300 Type A, shall be used for signs with a white background.
3. Orange sheeting, meeting the requirements of DMS-8300 Type B<sub>TL</sub> or Type C<sub>TL</sub>, shall be used for rigid signs with orange backgrounds.

**SIGN LETTERS**

1. All sign letters and numbers shall be clear, and open rounded type uppercase alphabet letters as approved by the Federal Highway Administration (FHWA) and as published in the "Standard Highway Sign Design for Texas" manual. Signs, letters and numbers shall be of first class workmanship in accordance with Department Standards and Specifications.

**REMOVING OR COVERING**

1. When sign messages may be confusing or do not apply, the signs shall be removed or completely covered.
2. Long-term stationary or intermediate stationary signs installed on square metal tubing may be turned away from traffic 90 degrees when the sign message is not applicable. This technique may not be used for signs installed in the median of divided highways or near any intersections where the sign may be seen from approaching traffic.
3. Signs installed on wooden skids shall not be turned at 90 degree angles to the roadway. These signs should be removed or completely covered when not required.
4. When signs are covered, the material used shall be opaque, such as heavy mil black plastic, or other materials which will cover the entire sign face and maintain their opaque properties under automobile headlights at night, without damaging the sign sheeting.
5. Burlap shall NOT be used to cover signs.
6. Dual tape or other adhesive material shall NOT be affixed to a sign face.
7. Signs and anchor stubs shall be removed and holes backfilled upon completion of work.

**SIGN SUPPORT WEIGHTS**

1. Where sign supports require the use of weights to keep from turning over, the use of sandbags with dry, cohesionless sand should be used.
2. The sandbags will be tied shut to keep the sand from spilling and to maintain a constant weight.
3. Rock, concrete, iron, steel or other solid objects shall not be permitted for use as sign support weights.
4. Sandbags should weigh a minimum of 35 lbs and a maximum of 50 lbs.
5. Sandbags shall be made of a durable material that tears upon vehicular impact. Rubber (such as fire inner tubes) shall NOT be used.
6. Rubber balls designed for channelizing devices should not be used for ballast on portable sign supports. Sign supports designed and manufactured with rubber bases may be used when shown on the CWTCD list.
7. Sandbags shall only be placed along or laid over the base supports of the traffic control device and shall not be suspended above ground level or hung with rope, wire, chains or other fasteners. Sandbags shall be placed along the length of the skids to weigh down the sign support.
8. Sandbags shall NOT be placed under the skid and shall not be used to level sign supports placed on slopes.

**FLAGS ON SIGNS**

1. Flags may be used to draw attention to warning signs. When used, the flag shall be 6 inches or larger and shall be orange fluorescent red-orange in color. Flags shall not be allowed to cover any portion of the sign face.

SHEET 4 OF 12



Texas  
Traffic  
Division  
Standard

**BARRICADE AND CONSTRUCTION  
TEMPORARY SIGN NOTES**

**BC (4) - 21**

FILE:	DC-21.dgn	REV:	TXDOT	CHK:	TXDOT	DATE:	TXDOT	BY:	TXDOT	DATE:	TXDOT
REVISED:	NOVEMBER 2002	CONT:	SECT	JOB:	HIGHWAY	DATE:	TXDOT	BY:	TXDOT	DATE:	TXDOT
REVISED:	9-07 8-14	BY:	TXDOT	DATE:	TXDOT	DATE:	TXDOT	BY:	TXDOT	DATE:	TXDOT
REVISED:	7-13 5-21	BY:	TXDOT	DATE:	TXDOT	DATE:	TXDOT	BY:	TXDOT	DATE:	TXDOT

DISCLAIMER: The use of this standard is governed by the "Texas Engineering Practice Act"; no warranty of any kind is made by the Texas Department of Transportation for the use of this standard to other formats or for incorrect results or damages resulting from its use.

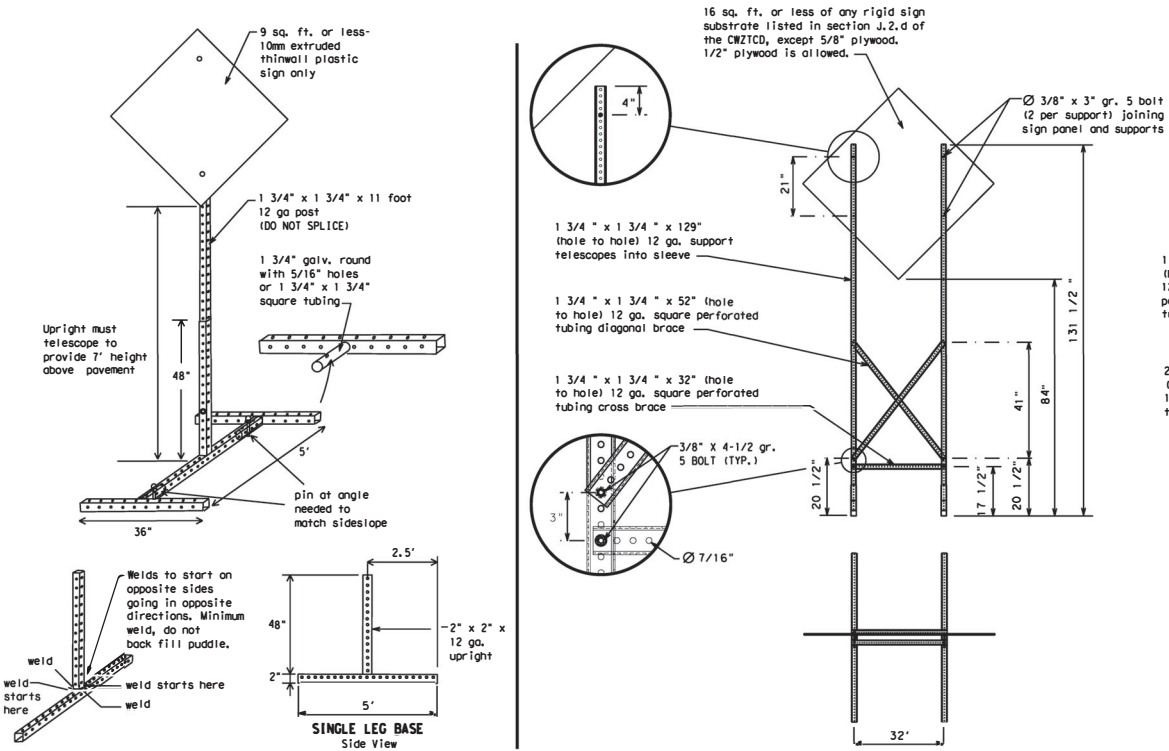
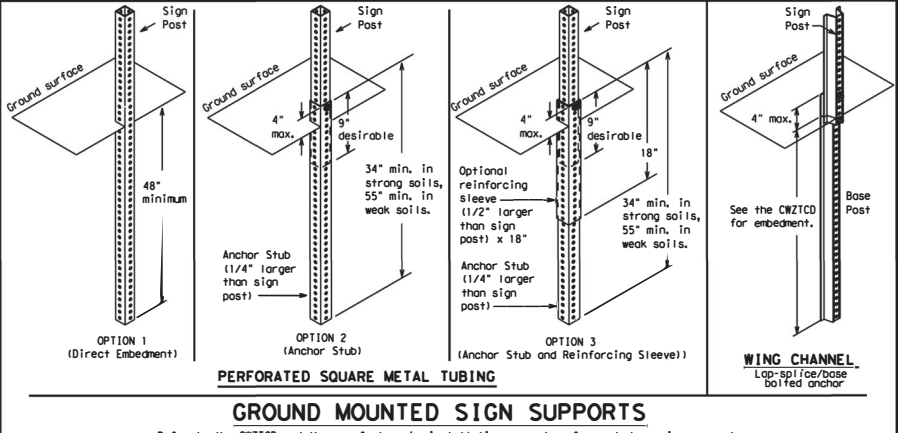
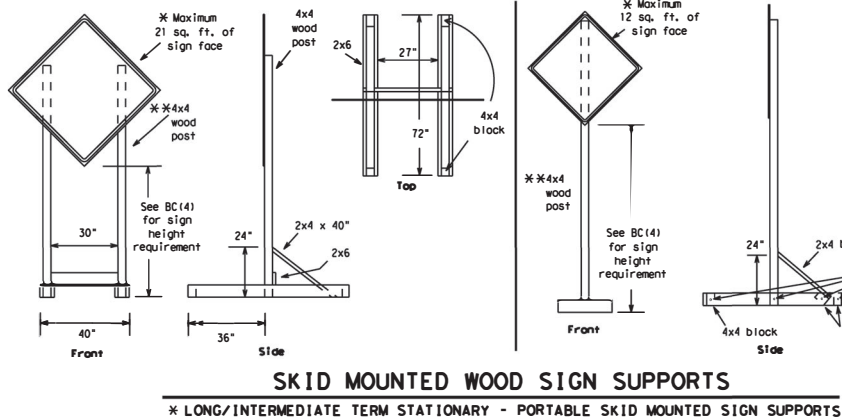

**SKID MOUNTED PERFORATED SQUARE STEEL TUBING SIGN SUPPORTS**  
 \* LONG/INTERMEDIATE TERM STATIONARY - PORTABLE SKID MOUNTED SIGN SUPPORTS

**WEDGE ANCHORS**  
 Both steel and plastic Wedge Anchor Systems as shown on the SMD Standard Sheets may be used as temporary sign supports for signs up to 10 square feet of sign face. They may be set in concrete or in sturdy soils if approved by the Engineer. (See web address for "Traffic Engineering Standard Sheets" on BC(1)).

**OTHER DESIGNS**  
 MORE DETAILS OF APPROVED LONG/INTERMEDIATE AND SHORT TERM SUPPORTS CAN BE FOUND ON THE CWZTCD LIST. SEE BC(1) FOR WEBSITE LOCATION.

- GENERAL NOTES**
1. Nails may be used in the assembly of wooden sign supports, but 3/8" bolts with nuts or 3/8" x 3 1/2" lag screws must be used on every joint for final connection.
  2. No more than 2 sign posts shall be placed within a 7 ft. circle, except for specific materials noted on the CWZTCD List.
  3. When project is completed, all sign supports and foundations shall be removed from the project site. This will be considered subsidiary to Item 502.
- \* See BC(4) for definition of "Work Duration."
  - \* \* Wood sign posts MUST be one piece. Splicing will NOT be allowed. Posts shall be painted white.
  - See the CWZTCD for the type of sign substrate that can be used for each approved sign support.

**BARRICADE AND CONSTRUCTION TYPICAL SIGN SUPPORT**

**BC (5) - 21**

FILE:	bc-21.dgn	DN:	TxDOT	CK:	TxDOT	DM:	TxDOT	CK:	TxDOT
© TxDOT	November 2002	CONT:		SECT:		JOB:		HIGHWAY:	
REVISIONS:		6440	15	001		TR 20, ETC.			
9-07	8-14	0157				COUNTY:		SHEET NO.:	
7-13	5-21	02				FILED IN:		31	

DATE: FILE:

WHEN NOT IN USE, REMOVE THE PCMS FROM THE RIGHT-OF-WAY OR PLACE THE PCMS BEHIND BARRIER OR GUARDRAIL WITH SIGN PANEL TURNED PARALLEL TO TRAFFIC

## RECOMMENDED PHASES AND FORMATS FOR PCMS MESSAGES DURING ROADWORK ACTIVITIES

(The Engineer may approve other messages not specifically covered here.)

### PORTABLE CHANGEABLE MESSAGE SIGNS

- The Engineer/Inspector shall approve all messages used on portable changeable message signs (PCMS).
- Messages on PCMS should contain no more than 8 words (about four to eight characters per word), not including simple words such as "TO," "FOR," "AT," etc.
- Messages should consist of a single phase, or two phases that alternate. Three-phase messages are not allowed. Each phase of the message should convey a single thought, and must be understood by itself.
- Use the word "EXIT" to refer to an exit ramp on a freeway; i.e., "EXIT CLOSED." Do not use the term "RAMP."
- Always use the route or interstate designation (IH, US, SH, FM) along with the number when referring to a roadway.
- When in use, the bottom of a stationary PCMS message panel should be a minimum 7 feet above the roadway, where possible.
- The message term "WEEKEND" should be used only if the work is to start on Saturday morning and end by Sunday evening at midnight. Actual days and hours of work should be displayed on the PCMS if work is to begin on Friday evening and/or continue into Monday morning.
- The Engineer/Inspector may select one of two options which are available for displaying a two-phase message on a PCMS. Each phase may be displayed for either four seconds each or for three seconds each.
- Do not "flash" messages or words included in a message. The message should be steady burn or continuous while displayed.
- Do not present redundant information on a two-phase message; i.e., keeping two lines of the message the same and changing the third line.
- Do not use the word "Danger" in message.
- Do not display the message "LANES SHIFT LEFT" or "LANES SHIFT RIGHT" on a PCMS. Drivers do not understand the message.
- Do not display messages that scroll horizontally or vertically across the face of the sign.
- The following table lists abbreviated words and two-word phrases that are acceptable for use on a PCMS. Both words in a phrase must be displayed together. Words or phrases not on this list should not be abbreviated, unless shown in the TMSJCD.
- PCMS character height should be at least 18 inches for trailer mounted units. They should be visible from at least 1/2 (.5) mile and the text should be legible from at least 600 feet at night and 800 feet in daylight. Truck mounted units must have a character height of 10 inches and must be legible from at least 400 feet.
- Each line of text should be centered on the message board rather than left or right justified.
- If disabled, the PCMS should default to an illegible display that will not alarm motorists and will only be used to alert workers that the PCMS has malfunctioned. A pattern such as a series of horizontal solid bars is appropriate.

### Phase 1: Condition Lists

#### Road/Lane/Ramp Closure List

FREEWAY CLOSED X MILE	FRONTAGE ROAD CLOSED
ROAD CLOSED AT SH XXX	SHOULDER CLOSED XXX FT
ROAD CLSD AT FM XXXX	RIGHT LN CLOSED XXX FT
RIGHT X LANES CLOSED	RIGHT X LANES OPEN
CENTER LANE CLOSED	DAYTIME LANE CLOSURES
NIGHT LANE CLOSURES	I-XX SOUTH EXIT CLOSED
VARIOUS LANES CLOSED	EXIT XXX CLOSED X MILE
EXIT CLOSED	RIGHT LN TO BE CLOSED
MALL DRIVEWAY CLOSED	X LANES CLOSED TUE - FRI
XXXXXXXX BLVD CLOSED	

#### Other Condition List

ROADWORK XXX FT	ROAD REPAIRS XXXX FT
FLAGGER XXXX FT	LANE NARROWS XXXX FT
RIGHT LN XXXX FT	TWO-WAY TRAFFIC XX MILE
MERGING TRAFFIC XXXX FT	CONST TRAFFIC XXX FT
LOOSE GRAVEL XXXX FT	UNEVEN LANES XXXX FT
ROADWORK PAST SH XXXX	ROADWORK NEXT FRI-SUN
BUMP XXXX FT	US XXX EXIT X MILES
TRAFFIC SIGNAL XXXX FT	LANES SHIFT *

\* LANES SHIFT in Phase 1 must be used with STAY IN LANE in Phase 2.

### Phase 2: Possible Component Lists

#### Action to Take/Effect on Travel List

MERGE RIGHT	FORM X LINES RIGHT
DETOUR NEXT X EXITS	USE XXXXX RD EXIT
USE EXIT XXX	USE EXIT I-XX NORTH
STAY ON US XXX SOUTH	USE I-XX E TO I-XX N
TRUCKS USE US XXX N	WATCH FOR TRUCKS
EXPECT DELAYS	PREPARE TO STOP
REDUCE SPEED XXX FT	END SHOULDER USE
USE OTHER ROUTES	WATCH FOR WORKERS
STAY IN LANE *	

#### Location List

AT FM XXXX
BEFORE RAILROAD CROSSING
NEXT X MILES
PAST US XXX EXIT
XXXXXXXX TO XXXXXXX
US XXX TO FM XXXX

#### Warning List

SPEED LIMIT XX MPH
MAXIMUM SPEED XX MPH
MINIMUM SPEED XX MPH
ADVISORY SPEED XX MPH
RIGHT LANE EXIT
USE CAUTION
DRIVE SAFELY
DRIVE WITH CARE

#### \*\* Advance Notice List

TUE-FRI XX AM-X PM
APR XX-XX X PM-X AM
BEGINS MONDAY
BEGINS MAY XX
MAY X-X XX PM - XX AM
NEXT FRI-SUN
XX AM TO XX PM
NEXT TUE AUG XX
TONIGHT XX PM-XX AM

\*\* See Application Guidelines Note 6.

### APPLICATION GUIDELINES

- Only 1 or 2 phases are to be used on a PCMS.
- The 1st phase (or both) should be selected from the "Road/Lane/Ramp Closure List" and the "Other Condition List".
- A 2nd phase can be selected from the "Action to Take/Effect on Travel, Location, General Warning, or Advance Notice Phase Lists".
- A Location Phase is necessary only if a distance or location is not included in the first phase selected.
- If two PCMS are used in sequence, they must be separated by a minimum of 1000 ft. Each PCMS shall be limited to two phases, and should be understandable by themselves.
- For advance notice, when the current date is within seven days of the actual work date, calendar days should be replaced with days of the week. Advance notification should typically be for no more than one week prior to the work.

### WORDING ALTERNATIVES

- The words RIGHT, LEFT and ALL can be interchanged as appropriate.
- Roadway designations IH, US, SH, FM and LP can be interchanged as appropriate.
- EAST, WEST, NORTH and SOUTH (or abbreviations E, W, N and S) can be interchanged as appropriate.
- Highway names and numbers replaced as appropriate.
- ROAD, HIGHWAY and FREEWAY can be interchanged as needed.
- AHEAD may be used instead of distances if necessary.
- FT and MI, MILE and MILES interchanged as appropriate.
- AT, BEFORE and PAST interchanged as needed.
- Distances or AHEAD can be eliminated from the message if a location phase is used.

SHEET 6 OF 12

PCMS SIGNS WITHIN THE R.O.W. SHALL BE BEHIND GUARDRAIL OR CONCRETE BARRIER OR SHALL HAVE A MINIMUM OF FOUR (4) PLASTIC DRUMS PLACED PERPENDICULAR TO TRAFFIC ON THE UPSTREAM SIDE OF THE PCMS, WHEN EXPOSED TO ONE DIRECTION OF TRAFFIC. WHEN EXPOSED TO TWO WAY TRAFFIC, THE FOUR DRUMS SHOULD BE PLACED WITH ONE DRUM AT EACH OF THE FOUR CORNERS OF THE UNIT.

### FULL MATRIX PCMS SIGNS

- When Full Matrix PCMS signs are used, the character height and legibility/visibility requirements shall be maintained as listed in Note 15 under "PORTABLE CHANGEABLE MESSAGE SIGNS" above.
- When symbol signs, such as the "Flagger Symbol" (CW20-7) are represented graphically on the Full Matrix PCMS sign and, with the approval of the Engineer, it shall maintain the legibility/visibility requirement listed above.
- When symbol signs are represented graphically on the Full Matrix PCMS, they shall only supplement the use of the static sign represented, and shall not substitute for, or replace that sign.
- A full matrix PCMS may be used to simulate a flashing arrow board provided it meets the visibility, flash rate and dimming requirements on BC(7), for the same size arrow.

DISCLAIMER: The use of this standard is governed by the "Texas Engineering Practice Act". No warranty of any kind is made by TxDOT for any purpose whatsoever. TxDOT assumes no responsibility for the conversion of this standard to other formats or for incorrect results or damage resulting from its use.

DATE: FILE:

WORD OR PHRASE	ABBREVIATION	WORD OR PHRASE	ABBREVIATION
Access Road	ACCESS RD	Major	MAJ
Alternate	ALT	Miles	MI
Avenue	AVE	Miles Per Hour	MPH
Best Route	BEST RTE	Minor	MNR
Boulevard	BLVD	Monday	MON
Bridge	BRDC	Normal	NORM
Cannot	CANT	North	N
Center	CTR	Northbound (route) N	
Construction Ahead	CONST AHD	Parking	PKING
CROSSING	XING	Road	RD
Detour Route	DETOUR RTE	Right Lane	RT LN
Do Not	DONT	Saturday	SAT
East	E	Service Road	SERV RD
Eastbound (route) E		Shoulder	SHLDR
Emergency	EMER	Slippery	SLIP
Emergency Vehicle	EMER VEH	South	S
Entrance, Enter	ENT	Southbound (route) S	
Express Lane	EXP LN	Speed	SPD
Expressway	EXPWY	Street	ST
XXXX Feet	XXXX FT	Sunday	SUN
Fog Ahead	FOG AHD	Telephone	PHONE
Freeway	FRWY, FWY	Temporary	TEMP
Freeway Blocked	FRW BLKD	Thursday	THURS
Friday	FRI	To Downtown	TO DWTN
Hazardous Driving	HAZ DRIVING	Traffic	TRAF
Hazardous Material	HAZMAT	Travelers	TRVLRS
High-Occupancy	HOV	Tuesday	TUES
Vehicle Highway	HWY	Time Minutes	TIME MIN
Hour(s)	HR, HRS	Upper Level	UPR LEVEL
Information	INFO	Vehicles (s)	VEH, VERS
It Is	ITS	Warning	WARN
Junction	JCT	Wednesday	WED
Left	LFT	Weight Limit	WT LIMIT
Left Lane	LFT LN	West	W
Lane Closed	LN CLOSED	Westbound (route) W	
Lower Level	LWR LEVEL	Wet Pavement	WET PVMT
Maintenance	MAINT	Will Not	WONT

Roadway designation = IH-number, US-number, SH-number, FM-number

Texas Department of Transportation Traffic Safety Division Standard

## BARRICADE AND CONSTRUCTION PORTABLE CHANGEABLE MESSAGE SIGN (PCMS)

### BC (6) - 21

FILE: bc-21.dgn	DR: TxDOT	CR: TxDOT	DP: TxDOT	CK: TxDOT
© TxDOT November 2002	CONT	SECT	JOB	HIGHWAY
REVISIONS	6440	15	001	SH 20, ETC.
9-07 8-14	DIST	COUNTY	SHEET NO.	
7-13 5-21	02	PALG PINTO	32	

DISCLAIMER: The use of this standard is governed by the "Texas Engineering Practice Act". No warranty of any kind is made by the Board of Transportation for the use of this standard or for incorrect results or damages resulting from its use.

- Barrier Reflectors shall be pre-qualified, and conform to the color and reflectivity requirements of DMS-8600. A list of prequalified Barrier Reflectors can be found at the Material Producer List web address shown on BC(1).
- Color of Barrier Reflectors shall be as specified in the TMTUCD. The cost of the reflectors shall be considered subsidiary to Item 512.

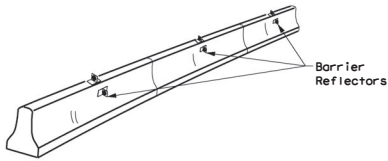

CONCRETE TRAFFIC BARRIER (CTB)

- Where traffic is on one side of the CTB, two (2) Barrier Reflectors shall be mounted in approximately the midsection of each section of CTB. An alternate mounting location is uniformly spaced at one end of each CTB. This will allow for attachment of a barrier grapple without damaging the reflector. The Barrier Reflector mounted on the side of the CTB shall be located directly below the reflector mounted on top of the barrier, as shown in the detail above.
- Where CTB separates two-way traffic, three barrier reflectors shall be mounted on each section of CTB. The reflector unit on top shall have two yellow reflective faces (Bi-Directional) while the reflectors on each side of the barrier shall have one yellow reflective face, as shown in the detail above.
- When CTB separates traffic traveling in the same direction, no barrier reflectors will be required on top of the CTB.
- Barrier Reflector units shall be yellow or white in color to match the edgeline being supplemented.
- Maximum spacing of Barrier Reflectors is forty (40) feet.
- Pavement markers or temporary flexible-reflective roadway marker tabs shall NOT be used as CTB delineation.
- Attachment of Barrier Reflectors to CTB shall be per manufacturer's recommendations.
- Missing or damaged Barrier Reflectors shall be replaced as directed by the Engineer.
- Single slope barriers shall be delineated as shown on the above detail.

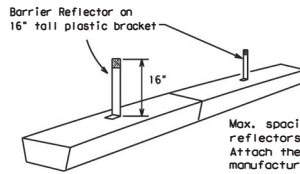

LOW PROFILE CONCRETE BARRIER (LPCB)

**LOW PROFILE CONCRETE BARRIER (LPCB) USED IN WORK ZONES**

LPCB is approved for use in work zone locations, where the posted speed is 45mph, or less. See Roadway Standard Sheet LPCB.

Max. spacing of barrier reflectors is 20 feet. Attach the delineators as per manufacturer's recommendations.

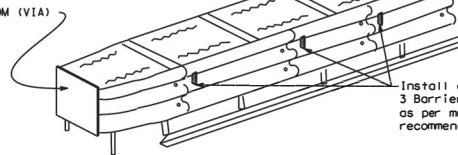

DELINEATION OF END TREATMENTS

**END TREATMENTS FOR CTB'S USED IN WORK ZONES**

End treatments used on CTB's in work zones shall meet the appropriate crashworthy standards as defined in the Manual for Assessing Safety Hardware (MASH). Refer to the CWZTCO List for approved end treatments and manufacturers.

**BARRIER REFLECTORS FOR CONCRETE TRAFFIC BARRIER AND ATTENUATORS**

**WARNING LIGHTS**

- Warning lights shall meet the requirements of the TMTUCD.
- Warning lights shall NOT be installed on barricades.
- Type A-Low Intensity Flashing Warning Lights are commonly used with drums. They are intended to warn of or mark a potentially hazardous area. Their use shall be as indicated on this sheet and/or other sheets of the plans by the designation "FL". The Type A Warning Lights shall not be used with signs manufactured with Type B<sub>1</sub> or C<sub>1</sub> Sheeting meeting the requirements of Departmental Material Specification DMS-8300.
- Type-C and Type D 360 degree Steady Burn Lights are intended to be used in a series for delineation to supplement other traffic control devices. Their use shall be as indicated on this sheet and/or other sheets of the plans by the designation "SB".
- The Engineer/Inspector or the plans shall specify the location and type of warning lights to be installed on the traffic control devices.
- When required by the Engineer, the Contractor shall furnish a copy of the warning lights certification. The warning light manufacturer will certify the warning lights meet the requirements of the latest ITE Purchase Specifications for Flashing and Steady-Burn Warning Lights.
- When used to delineate curves, Type-C and Type D Steady Burn Lights should only be placed on the outside of the curve, not the inside.
- The location of warning lights and warning reflectors on drums shall be as shown elsewhere in the plans.

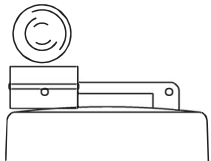

Type C Warning Light or approved substitute mounted on a drum adjacent to the travel way.

**WARNING LIGHTS MOUNTED ON PLASTIC DRUMS**

- Type A flashing warning lights are intended to warn drivers that they are approaching or are in a potentially hazardous area.
- Type A random flashing warning lights are not intended for delineation and shall not be used in a series.
- A series of sequential flashing warning lights placed on channelizing devices to form a merging taper may be used for delineation. If used, the successive flashing of the sequential warning lights should occur from the beginning of the taper to the end of the merging taper in order to identify the desired vehicle path. The rate of flashing for each light shall be 65 flashes per minute, plus or minus 10 flashes.
- Type C and D steady-burn warning lights are intended to be used in a series to delineate the edge of the travel lane on detours, on lane changes, on lane closures, and on other similar conditions.
- Type A, Type C and Type D warning lights shall be installed at locations as detailed on other sheets in the plans.
- Warning lights shall not be installed on a drum that has a sign, chevron or vertical panel.
- The maximum spacing for warning lights on drums should be identical to the channelizing device spacing.

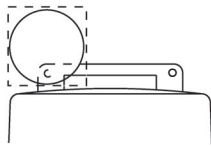

Warning reflector may be round or square. Must have a yellow reflective surface area of at least 30 square inches

**WARNING REFLECTORS MOUNTED ON PLASTIC DRUMS AS A SUBSTITUTE FOR TYPE C (STEADY BURN) WARNING LIGHTS**

- A warning reflector or approved substitute may be mounted on a plastic drum as a substitute for a Type C, steady burn warning light at the discretion of the Contractor unless otherwise noted in the plans.
- The warning reflector shall be yellow in color and shall be manufactured using a sign substrate approved for use with plastic drums listed on the CWZTCO.
- The warning reflector shall have a minimum retroreflective surface area (one-side) of 30 square inches.
- Round reflectors shall be fully reflectorized, including the area where attached to the drum.
- Square substrates must have a minimum of 30 square inches of reflectorized sheeting. They do not have to be reflectorized where it attaches to the drum.
- The side of the warning reflector facing approaching traffic shall have sheeting meeting the color and retroreflectivity requirements for DMS 8300-Type B or Type C.
- When used near two-way traffic, both sides of the warning reflector shall be reflectorized.
- The warning reflector should be mounted on the side of the handle nearest approaching traffic.
- The maximum spacing for warning reflectors should be identical to the channelizing device spacing requirements.

Arrow Boards may be located behind channelizing devices in place for a shoulder taper or merging taper, otherwise they shall be delineated with four (4) channelizing devices placed perpendicular to traffic on the upstream side of traffic.

- The Flashing Arrow Board should be used for all lane closures on multi-lane roadways, or slow moving maintenance or construction activities on the travel lanes.
- Flashing Arrow Boards should not be used on two-lane, two-way roadways, detours, diversions or work on shoulders unless the "CAUTION" display (see detail below) is used.
- The Engineer/Inspector shall choose all appropriate signs, barricades and/or other traffic control devices that should be used in conjunction with the Flashing Arrow Board.
- The Flashing Arrow Board should be able to display the following symbols:

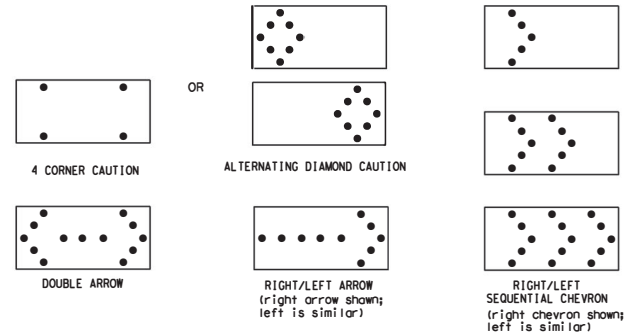

- The "CAUTION" display consists of four corner lamps flashing simultaneously, or the Alternating Diamond CAUTION mode as shown.
- The straight line caution display is NOT ALLOWED.
- The Flashing Arrow Board shall be capable of minimum 50 percent dimming from rated lamp voltage.
- The flashing rate of the lamps shall not be less than 25 nor more than 40 flashes per minute.
- Minimum lamp "on time" shall be approximately 50 percent for the flashing arrow and equal intervals of 25 percent for each sequential phase of the flashing chevron.
- The sequential arrow display is NOT ALLOWED.
- The flashing arrow display is the TxDOT standard; however, the sequential chevron display may be used during daylight operations.
- The Flashing Arrow Board shall be mounted on a vehicle, trailer or other suitable support.
- A Flashing Arrow Board SHALL NOT BE USED to laterally shift traffic.
- A full matrix PMS may be used to simulate a Flashing Arrow Board provided it meets visibility, flash rate and dimming requirements on this sheet for the same size arrow.
- Minimum mounting height of trailer mounted Arrow Boards should be 7 feet from roadway to bottom of panel.

REQUIREMENTS			
TYPE	MINIMUM SIZE	MINIMUM NUMBER OF PANEL LAMPS	MINIMUM VISIBILITY DISTANCE
B	30 x 60	13	3/4 mile
C	48 x 96	15	1 mile

**ATTENTION**  
Flashing Arrow Boards shall be equipped with automatic dimming devices.

WHEN NOT IN USE, REMOVE THE ARROW BOARD FROM THE RIGHT-OF-WAY OR PLACE THE ARROW BOARD BEHIND CONCRETE TRAFFIC BARRIER OR GUARDRAIL.

**FLASHING ARROW BOARDS**

SHEET 7 OF 12

**TRUCK-MOUNTED ATTENUATORS**

- Truck-mounted attenuators (TMA) used on TxDOT facilities must meet the requirements outlined in the Manual for Assessing Safety Hardware (MASH).
- Refer to the CWZTCO for the requirements of Level 2 or Level 3 TMAs.
- Refer to the CWZTCO for a list of approved TMAs.
- TMAs are required on freeways unless otherwise noted in the plans.
- A TMA should be used anytime that it can be positioned 30 to 100 feet in advance of the area of crew exposure without adversely affecting the work performance.
- The only reason a TMA should not be required is when a work area is spread down the roadway and the work crew is an extended distance from the TMA.



**BARRICADE AND CONSTRUCTION ARROW PANEL, REFLECTORS, WARNING LIGHTS & ATTENUATOR**

**BC (7) - 21**

FILED: bc-21.dgn	DATE: TxDOT	BY: TxDOT	DATE: TxDOT	BY: TxDOT
REVISED: 9-07 8-14	DATE: 11-07-2002	BY: 6440	DATE: 11-07-2002	BY: 6440
REVISED: 7-13 5-21	DATE: 11-07-2002	BY: 6440	DATE: 11-07-2002	BY: 6440
DATE: 11-07-2002	DATE: 11-07-2002	DATE: 11-07-2002	DATE: 11-07-2002	DATE: 11-07-2002

DATE: FILED:



DISCLAIMER: The use of this standard is governed by the "Texas Engineering, Experimenting, and Surveying Board" and the "Texas Board of Professional Engineers". No warranty, express or implied, is made by TxDOT for any use not intended by the Board. TxDOT is not responsible for any damages resulting from its use.

**GENERAL NOTES**

- For long term stationary work zones on freeways, drums shall be used as the primary channelizing device.
- For intermediate term stationary work zones on freeways, drums should be used as the primary channelizing device but may be replaced in tangent sections by vertical panels, or 42" two-piece cones. In tangent sections, one-piece cones may be used with the approval of the Engineer but only if personnel are present on the project at all times to maintain the cones in proper position and location.
- For short term stationary work zones on freeways, drums are the preferred channelizing device but may be replaced in tapers, transitions and tangent sections by vertical panels, two-piece cones or one-piece cones as approved by the Engineer.
- Drums and all related items shall comply with the requirements of the current version of the "Texas Manual on Uniform Traffic Control Devices" (TMUTCD) and the "Compliant Work Zone Traffic Control Devices List" (CWZTCD).
- Drums, bases, and related materials shall exhibit good workmanship and shall be free from objectionable marks or defects that would adversely affect their appearance or serviceability.
- The Contractor shall have a maximum of 24 hours to replace any plastic drums identified for replacement by the Engineer/Inspector. The replacement device must be an approved device.

**GENERAL DESIGN REQUIREMENTS**

- Pre-qualified plastic drums shall meet the following requirements:
- Plastic drums shall be a two-piece design; the "body" of the drum shall be the top portion and the "base" shall be the bottom.
  - The body and base shall lock together in such a manner that the body separates from the base when impacted by a vehicle traveling at a speed of 20 MPH or greater but prevents accidental separation due to normal handling and/or air turbulence created by passing vehicles.
  - Plastic drums shall be constructed of lightweight flexible, and deformable materials. The Contractor shall NOT use metal drums or single piece plastic drums as channelization devices or sign supports.
  - Drums shall present a profile that is a minimum of 18 inches in width at the 36 inch height when viewed from any direction. The height of drum unit (body installed on base) shall be a minimum of 36 inches and a maximum of 42 inches.
  - The top of the drum shall have a built-in handle for easy pickup and shall be designed to drain water and not collect debris. The handle shall have a minimum of two widely spaced 9/16 inch diameter holes to allow attachment of a warning light, warning reflector unit or approved compliant sign.
  - The exterior of the drum body shall have a minimum of four alternating orange and white retroreflective circumferential stripes not less than 4 inches nor greater than 8 inches in width. Any non-reflectorized space between any two adjacent stripes shall not exceed 2 inches in width.
  - Bases shall have a maximum width of 36 inches, a maximum height of 4 inches, and a minimum of two footholds of sufficient size to allow base to be held down while separating the drum body from the base.
  - Plastic drums shall be constructed of ultra-violet stabilized, orange, high-density polyethylene (HDPE) or other approved material.
  - Drum body shall have a maximum unballasted weight of 11 lbs.
  - Drum and base shall be marked with manufacturer's name and model number.

**RETROREFLECTIVE SHEETING**

- The stripes used on drums shall be constructed of sheeting meeting the color and retroreflectivity requirements of Departmental Materials Specification DMS-8300, "Sign Face Materials," Type A or Type B reflective sheeting shall be supplied unless otherwise specified in the plans.
- The sheeting shall be suitable for use on and shall adhere to the drum surface such that, upon vehicular impact, the sheeting shall remain adhered in-place and exhibit no delaminating, cracking, or loss of retroreflectivity other than that loss due to abrasion of the sheeting surface.

**BALLAST**

- Unballasted bases shall be large enough to hold up to 50 lbs. of sand. This base, when filled with the ballast material, should weigh between 35 lbs (minimum) and 50 lbs (maximum). The ballast may be sand in one to three sandbags separate from the base, sand in a sand-filled plastic base, or other ballasting devices as approved by the Engineer. Stacking of sandbags will be allowed, however height of sandbags above pavement surface may not exceed 12 inches.
- Bases with built-in ballast shall weigh between 40 lbs. and 50 lbs. Built-in ballast can be constructed of an integral crumb rubber base or a solid rubber base.
- Recycled truck tire sidewalls may be used for ballast on drums approved for this type of ballast on the CWZTD list.
- The ballast shall not be heavy objects, water, or any material that would become hazardous to motorists, pedestrians, or workers when the drum is struck by a vehicle.
- When used in regions susceptible to freezing, drums shall have drainage holes in the bottoms so that water will not collect and freeze becoming a hazard when struck by a vehicle.
- Ballast shall not be placed on top of drums.
- Adhesives may be used to secure base of drums to pavement.

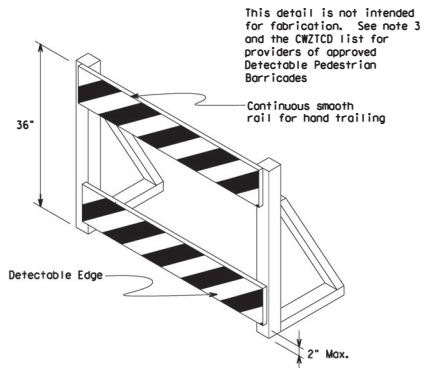
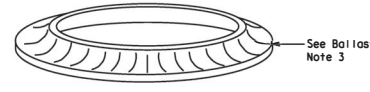
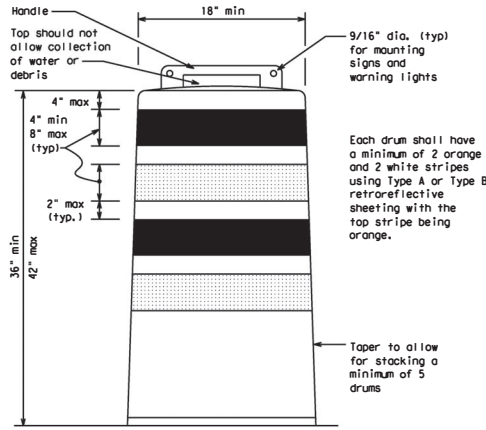

**DETECTABLE PEDESTRIAN BARRICADES**

- When existing pedestrian facilities are disrupted, closed, or relocated in a TTC zone, the temporary facilities shall be detectable and include accessibility features consistent with the features present in the existing pedestrian facility. Refer to WZ(BTS-2) for Pedestrian Control requirements for Sidewalk Diversions, Sidewalk Detours and Crosswalk Closures.
- Where pedestrians with visual disabilities normally use the closed sidewalk, a Detectable Pedestrian Barricade shall be placed across the full width of the closed sidewalk instead of a Type 3 Barricade.
- Detectable pedestrian barricades similar to the one pictured above, longitudinal channelizing devices, some concrete barriers, and wood or chain link fencing with a continuous detectable edging can satisfactorily delineate a pedestrian path.
- Tape, rope, or plastic chain strung between devices are not detectable, do not comply with the design standards in the "Americans with Disabilities Act Accessibility Guidelines (ADAAG)" and should not be used as a control for pedestrian movements.
- Warning lights shall not be attached to detectable pedestrian barricades.
- Detectable pedestrian barricades should use 8" nominal barricade rolls as shown on BC(10) provided that the top roll provides a smooth continuous roll suitable for hand trailing with no splinters, burrs, or sharp edges.

18" x 24" Sign (Maximum Sign Dimension)  
Chevron CW1-8, Opposing Traffic Lane Divider, Driveway sign D70a, Keep Right R4 series or other signs as approved by Engineer

12" x 24" Vertical Panel  
mount with diagonals sloping down towards travel way

**Plywood, Aluminum or Metal sign substrates shall NOT be used on plastic drums**

**SIGNS, CHEVRONS, AND VERTICAL PANELS MOUNTED ON PLASTIC DRUMS**

- Signs used on plastic drums shall be manufactured using substrates listed on the CWZTCD.
- Chevrons and other work zone signs with an orange background shall be manufactured with Type B<sub>2</sub> or Type C<sub>2</sub> Orange sheeting meeting the color and retroreflectivity requirements of DMS-8300, "Sign Face Material," unless otherwise specified in the plans.
- Vertical Panels shall be manufactured with orange and white sheeting meeting the requirements of DMS-8300 Type A or Type B. Diagonal stripes on Vertical Panels shall slope down toward the intended traveled lane.
- Other sign messages (text or symbolic) may be used as approved by the Engineer. Sign dimensions shall not exceed 18 inches in width or 24 inches in height, except for the R9 series signs discussed in note 8 below.
- Signs shall be installed using a 1/2 inch bolt (nominal) and nut, two washers, and one locking washer for each connection.
- Mounting bolts and nuts shall be fully engaged and adequately torqued. Bolts should not extend more than 1/2 inch beyond nuts.
- Chevrons may be placed on drums on the outside of curves, on merging tapers or on shifting tapers. When used in these locations, they may be placed on every drum or spaced not more than on every third drum. A minimum of three (3) should be used at each location called for in the plans.
- R9-9, R9-10, R9-11 and R9-11a Sidewalk Closed signs which are 24 inches wide may be mounted on plastic drums, with approval of the Engineer.

SHEET 8 OF 12

Texas Department of Transportation  
Traffic Safety Division Standard

**BARRICADE AND CONSTRUCTION CHANNELIZING DEVICES**

**BC (8) - 21**

FILE#	bc-21.dgn	DATE	TxDOT	DATE	TxDOT	DATE	TxDOT
REVISED	NOVEMBER 2002	COUNT	SECTION	JOB	HIGHWAY	DATE	ETC.
4-03	8-14	6440	15	001	SH 201, ETC.		
9-07	5-21	DIST	COUNTY	SHEET NO.			
7-13		02		PAID PRINT	34		

DATE FILED

DISCLAIMER: The use of this standard is governed by the "Texas Engineering Practice Act". No warranty of any kind is made by the Board of Professional Engineers, Architects, Surveyors and Landscape Architects of the State of Texas for any results or damages resulting from its use.

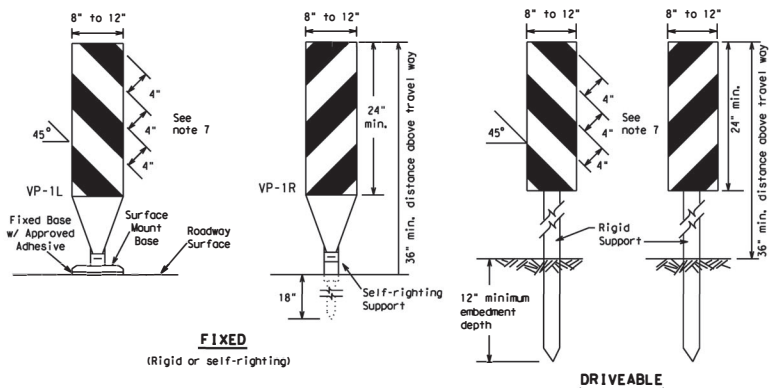

- Vertical Panels (VP's) are normally used to channelize traffic or divide opposing lanes of traffic.
- VP's may be used in daytime or nighttime situations. They may be used at the edge of shoulder drop-offs and other areas such as lane transitions where positive daytime and nighttime delineation is required. The Engineer/Inspector shall refer to the Roadway Design Manual for additional requirements on the use VP's for drop-offs.
- VP's should be mounted back to back if used at the edge of cuts adjacent to two-way two lane roadways. Stripes are to be reflective orange and reflective white and should always slope downward toward the travel lane.
- VP's used on expressways and freeways or other high speed roadways, may have more than 270 square inches of retroreflective area facing traffic.
- Self-righting supports are available with portable base. See "Compliant Work Zone Traffic Control Devices List" (CWZTCD).
- Sheeting for the VP's shall be retroreflective Type A or Type B conforming to Departmental Material Specification DMS-8300, unless noted otherwise.
- Where the height of reflective material on the vertical panel is 36 inches or greater, a panel stripe of 6 inches shall be used.

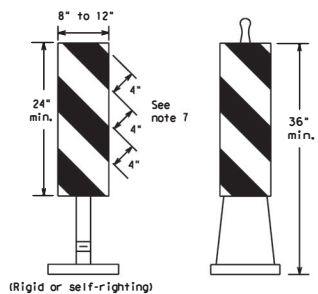

**VERTICAL PANELS (VPs)**

- Opposing Traffic Lane Dividers (OTLD) are delineation devices designed to convert a normal one-way roadway section to two-way operation. OTLD's are used on temporary centerlines. The upward and downward arrows on the sign's face indicate the direction of traffic on either side of the divider. The base is secured to the pavement with an adhesive or rubber weight to minimize movement caused by a vehicle impact or wind gust.
- The OTLD may be used in combination with 42" cones or VPs.
- Spacing between the OTLD shall not exceed 500 feet. 42" cones or VPs placed between the OTLD's should not exceed 100 foot spacing.
- The OTLD shall be orange with a black non-reflective legend. Sheeting for the OTLD shall be retroreflective Type B<sub>1</sub> or Type C<sub>1</sub> conforming to Departmental Material Specification DMS-8300, unless noted otherwise. The legend shall meet the requirements of DMS-8300.

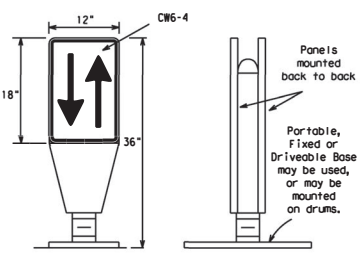

**OPPOSING TRAFFIC LANE DIVIDERS (OTLD)**

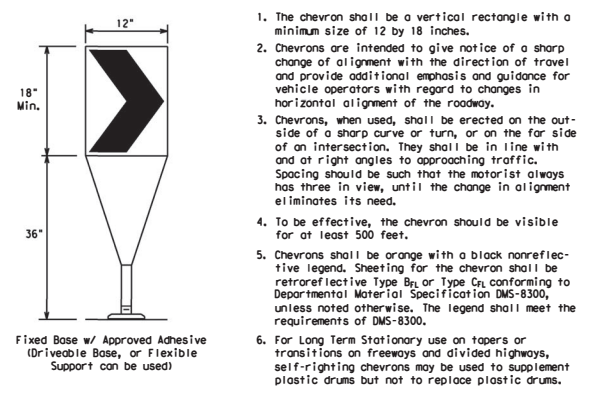

- The chevron shall be a vertical rectangle with a minimum size of 12 by 18 inches.
- Chevrons are intended to give notice of a sharp change of alignment with the direction of travel and provide additional emphasis and guidance for vehicle operators with regard to changes in horizontal alignment of the roadway.
- Chevrons, when used, shall be erected on the outside of a sharp curve or turn, or on the far side of an intersection. They shall be in line with and at right angles to approaching traffic. Spacing should be such that the motorist always has three in view, until the change in alignment eliminates its need.
- To be effective, the chevron should be visible for at least 500 feet.
- Chevrons shall be orange with a black nonreflective legend. Sheeting for the chevron shall be retroreflective Type B<sub>1</sub> or Type C<sub>1</sub> conforming to Departmental Material Specification DMS-8300, unless noted otherwise. The legend shall meet the requirements of DMS-8300.
- For Long Term Stationary use on tapers or transitions on freeways and divided highways, self-righting chevrons may be used to supplement plastic drums but not to replace plastic drums.

**CHEVRONS**

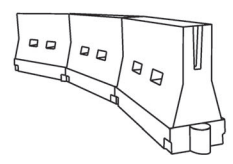

**LONGITUDINAL CHANNELIZING DEVICES (LCD)**

- LCDs are crashworthy, lightweight, deformable devices that are highly visible, have good target value and can be connected together. They are not designed to contain or redirect a vehicle on impact.
- LCDs may be used instead of a line of cones or drums.
- LCDs shall be placed in accordance to application and installation requirements specific to the device, and used only when shown on the CWZTCD list.
- LCDs should not be used to provide positive protection for obstacles, pedestrians or workers.
- LCDs shall be supplemented with retroreflective delineation as required for temporary barriers on BC(7) when placed roughly parallel to the travel lanes.
- LCDs used as barricades placed perpendicular to traffic should have at least one row of reflective sheeting meeting the requirements for barricade rails as shown on BC(10). Place reflective sheeting near the top of the LCD along the full length of the device.

**WATER BALLASTED SYSTEMS USED AS BARRIERS**

- Water ballasted systems used as barriers shall not be used solely to channelize road users, but also to protect the work space per the appropriate Manual for Assessing Safety Hardware (MASH) crashworthiness requirements based on roadway speed and barrier application.
- Water ballasted systems used to channelize vehicular traffic shall be supplemented with retroreflective delineation or channelizing devices to improve daytime/nighttime visibility. They may also be supplemented with pavement markings.
- Water ballasted systems used as barriers shall be placed in accordance to application and installation requirements specific to the device, and used only when shown on the CWZTCD list.
- Water ballasted systems used as barriers should not be used for a merging taper except in low speed (less than 45 MPH) urban areas. When used on a taper in a low speed urban area, the taper shall be delineated and the taper length should be designed to optimize road user operations considering the available geometric conditions.
- When water ballasted systems used as barriers have blunt ends exposed to traffic, they should be attenuated as per manufacturer recommendations or flared to a point outside the clear zone.

If used to channelize pedestrians, longitudinal channelizing devices or water ballasted systems must have a continuous detectable bottom for users of long cones and the top of the unit shall not be less than 32 inches in height.

**HOLLOW OR WATER BALLASTED SYSTEMS USED AS LONGITUDINAL CHANNELIZING DEVICES OR BARRIERS**

**GENERAL NOTES**

- Work Zone channelizing devices illustrated on this sheet may be installed in close proximity to traffic and are suitable for use on high or low speed roadways. The Engineer/Inspector shall ensure that spacing and placement is uniform and in accordance with the "Texas Manual on Uniform Traffic Control Devices" (TMUTCD).
- Channelizing devices shown on this sheet may have a driveable, fixed or portable base. The requirement for self-righting channelizing devices must be specified in the General Notes or other plan sheets.
- Channelizing devices on self-righting supports should be used in work zone areas where channelizing devices are frequently impacted by errant vehicles or vehicle related wind gusts making alignment of the channelizing devices difficult to maintain. Locations of these devices shall be detailed elsewhere in the plans. These devices shall conform to the TMUTCD and the "Compliant Work Zone Traffic Control Devices List" (CWZTCD).
- The Contractor shall maintain devices in a clean condition and replace damaged, nonreflective, faded, or broken devices and bases as required by the Engineer/Inspector. The Contractor shall be required to maintain proper device spacing and alignment.
- Portable bases shall be fabricated from virgin and/or recycled rubber. The portable bases shall weigh a minimum of 30 lbs.
- Pavement surfaces shall be prepared in a manner that ensures proper bonding between the adhesives, the fixed mount bases and the pavement surface. Adhesives shall be prepared and applied according to the manufacturer's recommendations.
- The installation and removal of channelizing devices shall not cause detrimental effects to the final pavement surfaces, including pavement surface discoloration or surface integrity. Driveable bases shall not be permitted on final pavement surfaces. The Engineer/Inspector shall approve all application and removal procedures of fixed bases.

Posted Speed	Formula	Minimum Desirable Taper Lengths *x			Suggested Maximum Spacing of Channelizing Devices	
		10' Offset	11' Offset	12' Offset	On a Taper	On a Tangent
30	L = WS / 60	150'	165'	180'	30'	60'
35		205'	225'	245'	35'	70'
40	L = WS	265'	295'	320'	40'	80'
45		450'	495'	540'	45'	90'
50		500'	550'	600'	50'	100'
55		550'	605'	660'	55'	110'
60		600'	660'	720'	60'	120'
65		650'	715'	780'	65'	130'
70		700'	770'	840'	70'	140'
75	750'	825'	900'	75'	150'	
80	800'	880'	960'	80'	160'	

\*x Taper lengths have been rounded off.  
L=Length of Taper (FT.) W=Width of Offset (FT.)  
S=Posted Speed (MPH)

**SUGGESTED MAXIMUM SPACING OF CHANNELIZING DEVICES AND MINIMUM DESIRABLE TAPER LENGTHS.**

SHEET 9 OF 12



Texas Department of Transportation  
Traffic Safety Division Standard

**BARRICADE AND CONSTRUCTION CHANNELIZING DEVICES**

BC (9) - 21

FILE:	bc-21.dgn	DN:	TxDOT	CK:	TxDOT	DR:	TxDOT	CR:	TxDOT
© TxDOT	November 2002	CONT:	SECT	JOB	HIGHWAY				
6440	15	001	IH 20, ETC.						
9-07	8-14	DIST:	COUNTY		SHEET NO.				
7-13	5-21	02	PALO PINTO		35				

DATE: FILE:

DISCLAIMER: The use of this standard is governed by the "Texas Engineering Practice Act". No warranty of any kind is made by TxDOT for any purpose whatsoever. The user assumes all liability for the conversion of this standard to other formats and for any damage resulting from its use.

DATE FILED

**TYPE 3 BARRICADES**

1. Refer to the Compliant Work Zone Traffic Control Devices List (CWZTCD) for details of the Type 3 Barricades and a list of all materials used in the construction of Type 3 Barricades.
2. Type 3 Barricades shall be used at each end of construction projects closed to all traffic.
3. Barricades extending across a roadway should have stripes that slope downward in the direction toward which traffic must turn in detouring. When both right and left turns are provided, the chevron striping may slope downward in both directions from the center of the barricade. Where no turns are provided at a closed road, striping should slope downward in both directions toward the center of roadway.
4. Striping of rails, for the right side of the roadway, should slope downward to the left. For the left side of the roadway, striping should slope downward to the right.
5. Identification markings may be shown only on the back of the barricade rails. The maximum height of letters and/or company logos used for identification shall be 1".
6. Barricades shall not be placed parallel to traffic unless an adequate clear zone is provided.
7. Warning lights shall NOT be installed on barricades.
8. Where barricades require the use of weights to keep from turning over, the use of sandbags with dry, cohesionless sand is recommended. The sandbags will be tied shut to keep the sand from spilling and to maintain a constant weight. Sand bags shall not be stacked in a manner that covers any portion of a barricade rails reflective sheeting. Rock, concrete, iron, steel or other solid objects will NOT be permitted. Sandbags should weigh a minimum of 35 lbs and a maximum of 50 lbs. Sandbags shall be made of a durable material that tears upon vehicular impact. Rubber (such as tire inner tubes) shall not be used for sandbags. Sandbags shall only be placed along or upon the base supports of the device and shall not be suspended above ground level or hung with rope, wire, chains or other fasteners.
9. Sheeting for barricades shall be retroreflective Type A or Type B conforming to Departmental Material Specification DMS-8300 unless otherwise noted.

Barricades shall NOT be used as a sign support.



**TYPICAL STRIPING DETAIL FOR BARRICADE RAIL**

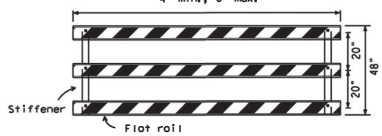

**TYPICAL PANEL DETAIL FOR SKID OR POST TYPE BARRICADES**

Each roadway of a divided highway shall be barricaded in the same manner.

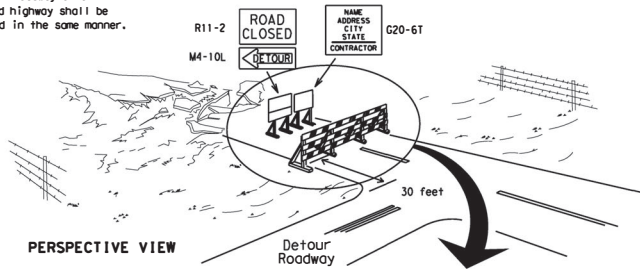

**PERSPECTIVE VIEW**

The three rails on Type 3 barricades shall be reflectorized orange and reflective white stripes on one side facing one-way traffic and both sides for two-way traffic. Barricade striping should slant downward in the direction of detour.

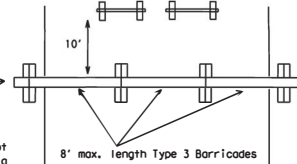

**PLAN VIEW**

1. Signs should be mounted on independent supports at a 7 foot mounting height in center of roadway. The signs should be a minimum of 10 feet behind Type 3 Barricades.
2. Advance signing shall be as specified elsewhere in the plans.

**TYPE 3 BARRICADE (POST AND SKID) TYPICAL APPLICATION**

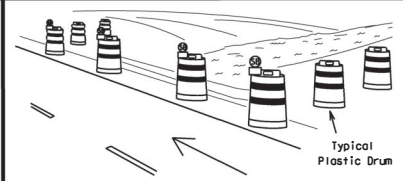

**PERSPECTIVE VIEW**

These drums are not required on one-way roadway

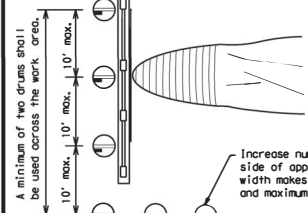

**PLAN VIEW**

Increase number of plastic drums on the side of approaching traffic if the crown width makes it necessary. (minimum of 2 and maximum of 4 drums)

1. Where positive redirection capability is provided, drums may be omitted.
2. Plastic construction fencing may be used with drums for safety as required in the plans.
3. Vertical Panels on flexible support may be substituted for drums when the shoulder width is less than 4 feet.
4. When the shoulder width is greater than 12 feet, steady-burn lights may be omitted if drums are used.
5. Drums must extend the length of the culvert widening.

LEGEND	
	Plastic drum
	Plastic drum with steady burn light or yellow warning reflector
	Steady burn warning light or yellow warning reflector

**CULVERT WIDENING OR OTHER ISOLATED WORK WITHIN THE PROJECT LIMITS**

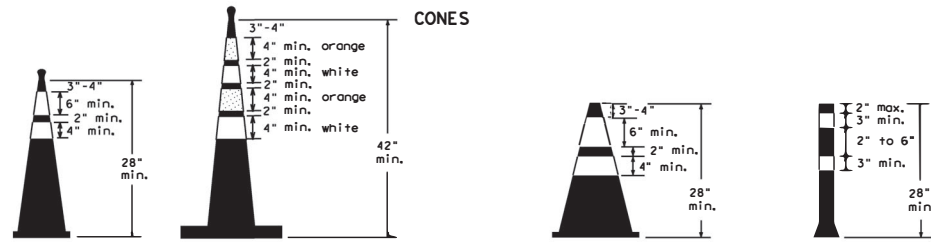

**Two-Piece cones**

**One-Piece cones**

**Tubular Marker**

28" Cones shall have a minimum weight of 9 1/2 lbs.  
42" 2-piece cones shall have a minimum weight of 30 lbs. including base.

1. Traffic cones and tubular markers shall be predominantly orange, and meet the height and weight requirements shown above.
2. One-piece cones have the body and base of the cone molded in one consolidated unit. Two-piece cones have a cone shaped body and a separate rubber base, or ballast, that is added to keep the device upright and in place.
3. Two-piece cones may have a handle or loop extending up to 8" above the minimum height shown, in order to aid in retrieving the device.
4. Cones or tubular markers shall have white or white and orange reflective bands as shown above. The reflective bands shall have a smooth, sealed outer surface and meet the requirements of Departmental Material Specification DMS-8300 Type A or Type B.
5. 28" cones and tubular markers are generally suitable for short duration and short-term stationary work as defined on BC(4). These should not be used for intermediate-term or long-term stationary work unless personnel is on-site to maintain them in their proper upright position.
6. 42" two-piece cones, vertical panels or drums are suitable for all work zone durations.
7. Cones or tubular markers used on each project should be of the same size and shape.

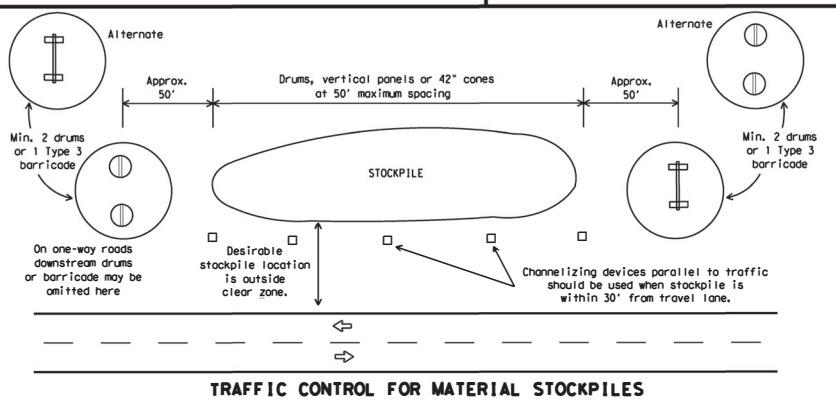

**TRAFFIC CONTROL FOR MATERIAL STOCKPILES**

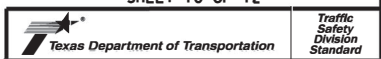

**BARRICADE AND CONSTRUCTION CHANNELIZING DEVICES**

**BC (10) - 21**

FILE#	BC-21.dgn	DW	TxDOT	CK	TxDOT	DW	TxDOT	CK	TxDOT
REV	1	DATE	NOVEMBER 2002	CONT	SECT	JOB	HIGHWAY		
9-07	8-14	DIST	6440	15	001	SH 20, ETC.			
7-13	5-21	02			COUNTY	PALO PINTO	SHEET NO.		36

DISCLAIMER: The use of this standard is governed by the "Texas Engineering Practice Act". No warranty of any kind is made by TxDOT for any purpose whatsoever. TxDOT assumes no responsibility for the conversion of this standard to other formats or for incorrect results or damages resulting from its use.

DATE: FILE:

## WORK ZONE PAVEMENT MARKINGS

### GENERAL

- The Contractor shall be responsible for maintaining work zone and existing pavement markings, in accordance with the standard specifications and special provisions, on all roadways open to traffic within the CSJ limits unless otherwise stated in the plans.
- Color, patterns and dimensions shall be in conformance with the "Texas Manual on Uniform Traffic Control Devices" (TMUTCD).
- Additional supplemental pavement marking details may be found in the plans or specifications.
- Pavement markings shall be installed in accordance with the TMUTCD and as shown on the plans.
- When short term markings are required on the plans, short term markings shall conform with the TMUTCD, the plans and details as shown on the Standard Plan Sheet WZ(STPM).
- When standard pavement markings are not in place and the roadway is opened to traffic, DO NOT PASS signs shall be erected to mark the beginning of the sections where passing is prohibited and PASS WITH CARE signs at the beginning of sections where passing is permitted.
- All work zone pavement markings shall be installed in accordance with Item 662, "Work Zone Pavement Markings."

### RAISED PAVEMENT MARKERS

- Raised pavement markers are to be placed according to the patterns on BC(11).
- All raised pavement markers used for work zone markings shall meet the requirements of Item 672, "RAISED PAVEMENT MARKERS" and Departmental Material Specification DMS-4200 or DMS-4300.

### PREFABRICATED PAVEMENT MARKINGS

- Removable prefabricated pavement markings shall meet the requirements of DMS-8241.
- Non-removable prefabricated pavement markings (fall back) shall meet the requirements of DMS-8240.

### MAINTAINING WORK ZONE PAVEMENT MARKINGS

- The Contractor will be responsible for maintaining work zone pavement markings within the work limits.
- Work zone pavement markings shall be inspected in accordance with the frequency and reporting requirements of work zone traffic control device inspections as required by Form 599.
- The markings should provide a visible reference for a minimum distance of 300 feet during normal daylight hours and 160 feet when illuminated by automobile low-beam headlights at night, unless sight distance is restricted by roadway geometrics.
- Markings failing to meet this criteria within the first 30 days after placement shall be replaced at the expense of the Contractor as per Specification Item 662.

### REMOVAL OF PAVEMENT MARKINGS

- Pavement markings that are no longer applicable, could create confusion or direct a motorist toward or into the closed portion of the roadway shall be removed or obliterated before the roadway is opened to traffic.
- The above shall not apply to detours in place for less than three days, where flaggers and/or sufficient channelizing devices are used in lieu of markings to outline the detour route.
- Pavement markings shall be removed to the fullest extent possible, so as not to leave a discernable marking. This shall be by any method approved by TxDOT Specification Item 677 for "Eliminating Existing Pavement Markings and Markers".
- The removal of pavement markings may require resurfacing or seal coating portions of the roadway as described in Item 677.
- Subject to the approval of the Engineer, any method that proves to be successful on a particular type pavement may be used.
- Blast cleaning may be used but will not be required unless specifically shown in the plans.
- Over-pointing of the markings SHALL NOT BE permitted.
- Removal of raised pavement markers shall be as directed by the Engineer.
- Removal of existing pavement markings and markers will be paid for directly in accordance with Item 677, "ELIMINATING EXISTING PAVEMENT MARKINGS AND MARKERS," unless otherwise stated in the plans.
- Black-out marking tape may be used to cover conflicting existing markings for periods less than two weeks when approved by the Engineer.

## Temporary Flexible-Reflective Roadway Marker Tabs

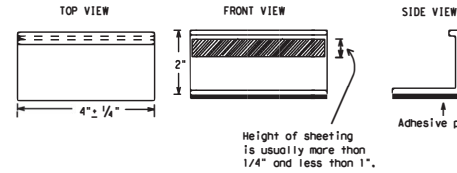

**STAPLES OR NAILS SHALL NOT BE USED TO SECURE TEMPORARY FLEXIBLE-REFLECTIVE ROADWAY MARKER TABS TO THE PAVEMENT SURFACE**

- Temporary flexible-reflective roadway marker tabs used as guidemarks shall meet the requirements of DMS-8242.
- Tabs detailed on this sheet are to be inspected and accepted by the Engineer or designated representative. Sampling and testing is not normally required, however at the option of the Engineer, either "A" or "B" below may be imposed to assure quality before placement on the roadway.
  - Select five (5) or more tabs at random from each lot or shipment and submit to the Construction Division, Materials and Pavement Section to determine specification compliance.
  - Select five (5) tabs and perform the following test. Affix five (5) tabs at 24 inch intervals on an asphaltic pavement in a straight line. Using a medium size passenger vehicle or pickup, run over the markers with the front and rear tires at a speed of 35 to 40 miles per hour, four (4) times in each direction. No more than one (1) out of the five (5) reflective surfaces shall be lost or displaced as a result of this test.
- Small design variances may be noted between tab manufacturers.
- See Standard Sheet WZ(STPM) for tab placement on new pavements. See Standard Sheet TCP(T-1) for tab placement on seal coat work.

### RAISED PAVEMENT MARKERS USED AS GUIDEMARKS

- Raised pavement markers used as guidemarks shall be from the approved product list, and meet the requirements of DMS-4200.
- All temporary construction raised pavement markers provided on a project shall be of the same manufacturer.
- Adhesive for guidemarks shall be bituminous material hot applied or butyl rubber pad for all surfaces, or thermoplastic for concrete surfaces.

Guidemarks shall be designated as:  
 YELLOW - (two amber reflective surfaces with yellow body).  
 WHITE - (one silver reflective surface with white body).

DEPARTMENTAL MATERIAL SPECIFICATIONS	
PAVEMENT MARKERS (REFLECTORIZED)	DMS-4200
TRAFFIC BUTTONS	DMS-4300
EPOXY AND ADHESIVES	DMS-6100
BITUMINOUS ADHESIVE FOR PAVEMENT MARKERS	DMS-6130
PERMANENT PREFABRICATED PAVEMENT MARKINGS	DMS-8240
TEMPORARY REMOVABLE, PREFABRICATED PAVEMENT MARKINGS	DMS-8241
TEMPORARY FLEXIBLE, REFLECTIVE ROADWAY MARKER TABS	DMS-8242

A list of prequalified reflective raised pavement markers, non-reflective traffic buttons, roadway marker tabs and other pavement markings can be found at the Material Producer List web address shown on BC(11).

SHEET 11 OF 12



## BARRICADE AND CONSTRUCTION PAVEMENT MARKINGS

**BC(11)-21**

FILE#	bc-21.dgn	2nd	TxDOT	CHK	TxDOT	DRW	TxDOT	CRK	TxDOT
CONT	TxDOT February 1998	REV	SECT	JOB	IN	20	ETC.		
REV	2-98	9-07	5-21						
	1-02	7-13							
	11-02	8-14							
DIST		COUNTY		SHEET NO.					
	02	PALO PINTO		37					

DISCLAIMER: The use of this standard is governed by the "Texas Engineering Practice Act". No warranty of any kind is made by the Texas Department of Transportation for the use of this standard or for incorrect results or damages resulting from its use.

### PAVEMENT MARKING PATTERNS

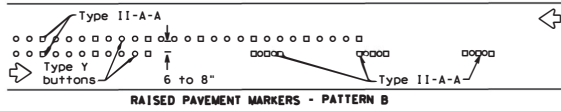
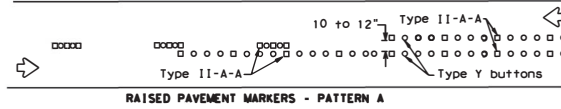
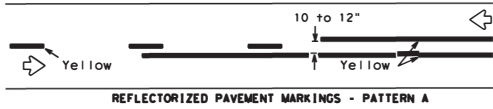

Pattern A is the TxDOT Standard, however Pattern B may be used if approved by the Engineer. Prefabricated markings may be substituted for reflectORIZED pavement markings.

### CENTER LINE & NO-PASSING ZONE BARRIER LINES FOR TWO-LANE, TWO-WAY HIGHWAYS

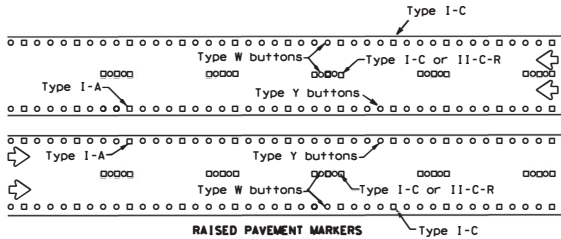
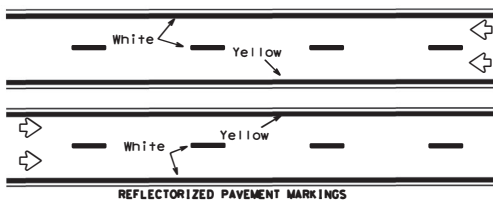

Prefabricated markings may be substituted for reflectORIZED pavement markings.

### EDGE & LANE LINES FOR DIVIDED HIGHWAY

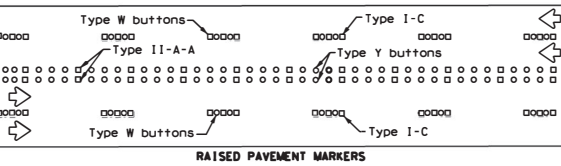
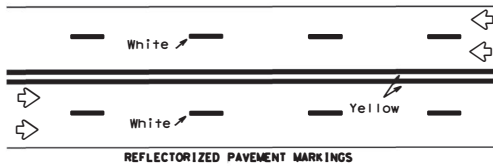

Prefabricated markings may be substituted for reflectORIZED pavement markings.

### LANE & CENTER LINES FOR MULTILANE UNDIVIDED HIGHWAYS

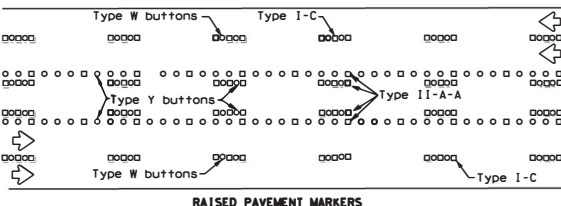
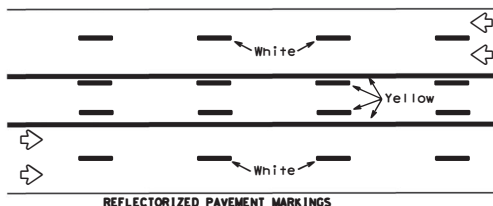

Prefabricated markings may be substituted for reflectORIZED pavement markings.

### TWO-WAY LEFT TURN LANE

### STANDARD WORK ZONE PAVEMENT MARKINGS DETAILS

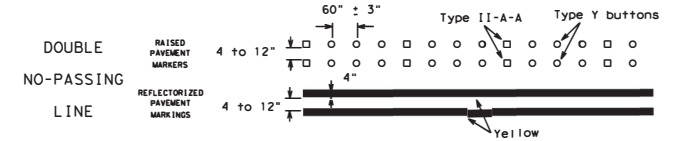

### SOLID LINES

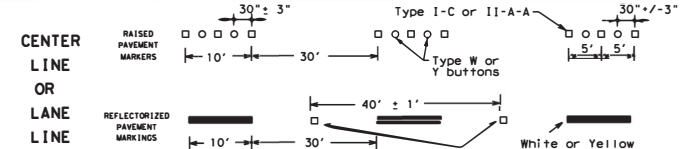
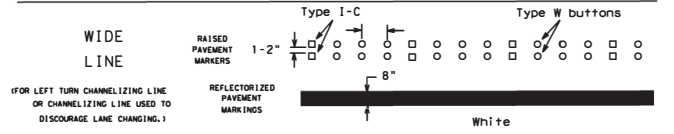
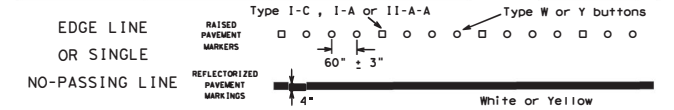

### BROKEN LINES

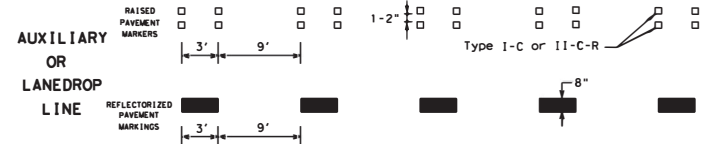

### REMOVABLE MARKINGS WITH RAISED PAVEMENT MARKERS

If raised pavement markers are used to supplement REMOVABLE markings, the markers shall be applied to the top of the tape at the approximate mid length of tape used for broken lines or at 20 foot spacing for solid lines. This allows an easier removal of raised pavement markers and tape.

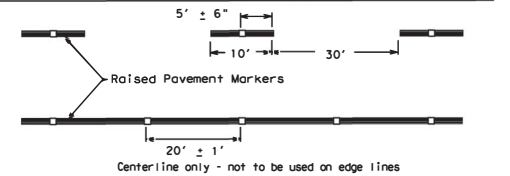

SHEET 12 OF 12



### BARRICADE AND CONSTRUCTION PAVEMENT MARKING PATTERNS

BC (12) - 21

Raised pavement markers used as standard pavement markings shall be from the approved products list and meet the requirements of Item 672 "RAISED PAVEMENT MARKERS."

FILE: bc-21.dgn	DN: TxDOT	CR: TxDOT	OR: TxDOT	CR: TxDOT
© TxDOT February 1998	CONT	SECT	JOB	HIGHWAY
REVISIONS	6440	15	001	IR 200, ETC.
1-97 9-07 5-21				
2-98 7-13				
11-02 8-14				
	02		PAID PRINT	38

DATE FILED

DISCLAIMER: The use of this standard is governed by the "Texas Engineering Practice Act". No warranty of any kind is made by TxDOT for any purpose whatsoever. TxDOT assumes no responsibility for the conversion of this standard to other formats or for incorrect results or damages resulting from its use.

DATE: FILE:

Warning sign and rumble strip sequence in opposite direction is same as below.

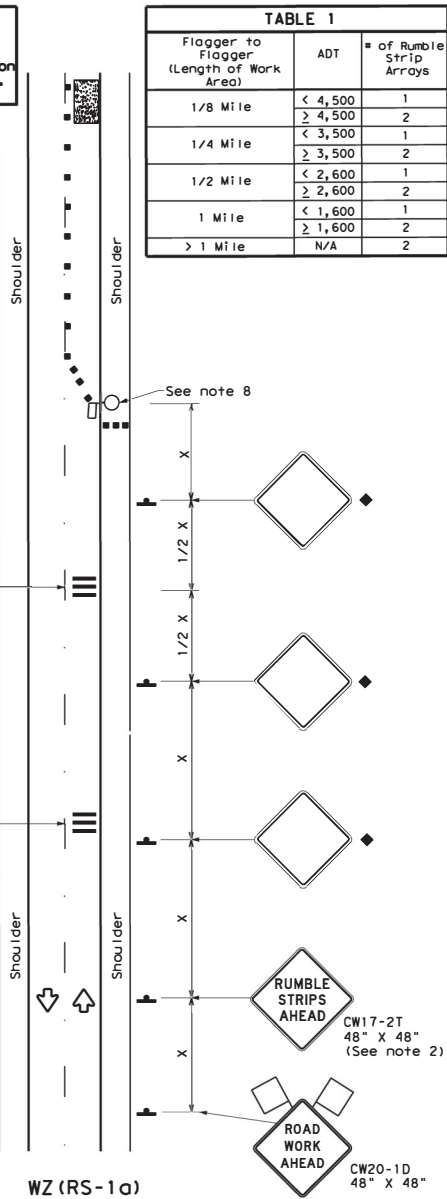

**RUMBLE STRIPS ON ONE-LANE TWO-WAY APPLICATION**

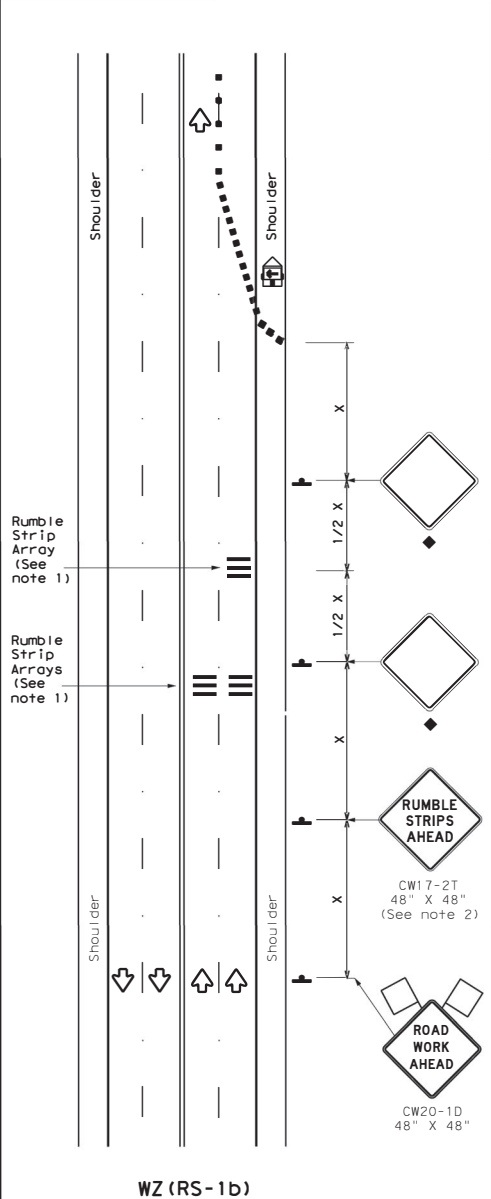

**RUMBLE STRIPS FOR LANE CLOSURE ON CONVENTIONAL ROADWAY**

**GENERAL NOTES**

- Each Rumble Strip Array should consist of three rumble strips spaced center to center at the spacing shown in Table 2, placed transverse across the lane at locations shown.
- The CW17-2T "RUMBLE STRIPS AHEAD" sign should be located after the CW20-1D "ROAD WORK AHEAD" sign and spaced as shown. If traffic is observed to be queuing, or is expected to queue beyond the Rumble Strips, the CW17-2T sign and the first Rumble Strip Array may be located upstream of the CW20-1D sign as necessary to provide needed warning.
- Temporary Rumble Strips will be considered subsidiary to Item 502, and shall be a product listed on the Compliant Work Zone Traffic Control Devices.
- Remove Temporary Rumble Strips before removing the advanced warning signs.
- Temporary Rumble Strips should not be used on horizontal curves, loose gravel, soft or bleeding asphalt, heavily rutted pavements or unpaved surfaces.
- Temporary Rumble Strips shall be installed and maintained as per manufacturer's recommendations.
- This standard sheet shall be used in conjunction with other appropriate TCP standard, TMUTCD typical application or project specific detail for the project.
- The one-lane two-way application may utilize a flagger, an Automated Flagger Assistance Device (AFAD) or a Portable Traffic Signal (PTS).
- Replace defective Temporary Rumble Strips as directed by the Engineer.
- Temporary Rumble Strips may be used on freeways or expressways based on engineering judgment and written direction from the Engineer.

LEGEND			
	Type 3 Barricade		Channelizing Devices
	Heavy Work Vehicle		Truck Mounted Attenuator (TMA)
	Trailer Mounted Flashing Arrow Panel		Portable Changeable Message Sign (PCMS)
	Sign		Traffic Flow
	Flagger		Flagger

Posted Speed *	Formula *	Minimum Desirable Taper Lengths **		Suggested Maximum Spacing of Channelizing Devices		Minimum Sign Spacing "x"	Suggested Longitudinal Buffer Space "b"
		10' Offset	12' Offset	On a Taper	On a Tangent		
30	L = WS / 60	150'	165'	180'	30'	60'	120'
35		205'	225'	245'	35'	70'	160'
40		265'	295'	320'	40'	80'	240'
45	L = WS	450'	495'	540'	45'	90'	320'
50		500'	550'	600'	50'	100'	400'
55		550'	605'	660'	55'	110'	500'
60		600'	660'	720'	60'	120'	600'
65		650'	715'	780'	65'	130'	700'
70	700'	770'	840'	70'	140'	800'	
75	750'	825'	900'	75'	150'	900'	

\* Conventional Roads Only  
 \*\* Taper lengths have been rounded off.  
 L=Length of Taper (FT) W=Width of Offset (FT)  
 S=Posted Speed (MPH)

TYPICAL USAGE				
MOBILE	SHORT DURATION	SHORT TERM STATIONARY	INTERMEDIATE TERM STATIONARY	LONG TERM STATIONARY
	✓	✓		

◆ Signs are for illustrative purposes only. Signs required may vary depending on the TCP, TMUTCD Typical Application, or project specific details for the project.

\* For posted speeds in excess of 65 MPH, it is recommended that spacing is increased as speed limits increase. Increasing space between rumble strips will improve effectiveness.

Speed	Approximate distance between strips in an array
≤ 40 MPH	10'
> 40 MPH & ≤ 55 MPH	15'
= 60 MPH	20'
≥ 65 MPH	* 35' +

Texas Department of Transportation  
Traffic Safety Division Standard

## TEMPORARY RUMBLE STRIPS

### WZ (RS) - 22

FILE: wzs22.dgn	DN: TxDOT	CR: TxDOT	DN: TxDOT	CR: TxDOT
© TxDOT November 2012	CONT	SECT	JOB	HIGHWAY
REVISIONS	B440	15	001	1H 20, ETC.
2-14 4-16	DIST	COUNTY	SHEET NO.	
	02	PALO PINTO	39	

"Texas Engineering Practice Act". No warranty of any kind is made by TxDOT for any purpose whatsoever. TxDOT assumes no responsibility for the conversion of this standard to other formats or for incorrect results or damages resulting from its use.

LEVELS DISPLAYED:  
 1 12 13 14 15 16 17 18 19 20 21 22 23 24 25 26 27 28 29 30 31 32  
 33 34 35 36 37 38 39 40 41 42 43 44 45 46 47 48  
 49 50 51 52 53 54 55 56 57 58 59 60 61 62 63

### EXAMPLES OF SIGN SUPPORTS

See the CWZTCD for the type of sign substrate that can be used for each approved sign support.

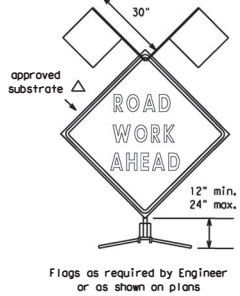

#### SHORT TERM DURATION, DAYTIME USE ONLY PORTABLE SIGN SUPPORTS

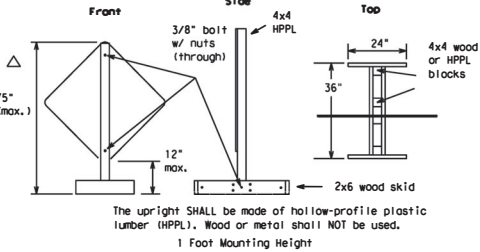

Attachment to wooden supports will be by bolts and nuts or screws. Use TxDOT's or manufacturer's recommended procedures for attaching sign substrates to other types of sign supports.

**Nails will NOT be allowed.**

The upright SHALL be made of hollow-profile plastic lumber (HPPL). Wood or metal shall NOT be used.  
1 Foot Mounting Height

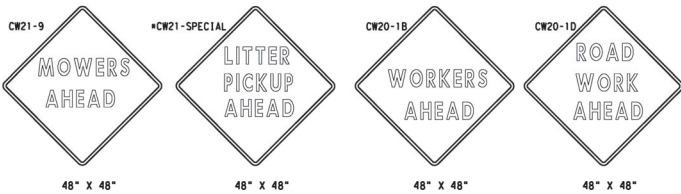

**SIGN IN ACCORDANCE WITH THE TEXAS MANUAL ON UNIFORM TRAFFIC CONTROL DEVICES FOR STREETS AND HIGHWAYS**

**MOWERS AHEAD SIGNS ARE USED FOR MOWING OPERATIONS.**

**LITTER PICKUP AHEAD, ROAD WORK AHEAD AND WORKER AHEAD SIGNS ARE USED AS DIRECTED FOR OTHER MAINTENANCE OPERATIONS WHEN ALL WORK OCCURS OFF OF THE PAVED HIGHWAY SURFACE.**

#### ROLL-UP SIGNS CONFORMING TO DMS-8310 AND THE CWZTCD ALLOWED

\*Letter dimensions and spacing for "CW21-SPECIAL" is the same as C20-1D

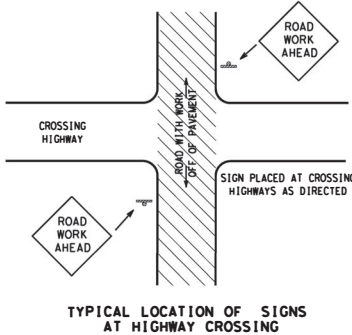

TYPICAL LOCATION OF SIGNS AT HIGHWAY CROSSING

WORK AREA IS A MAXIMUM OF 2.0 MILES UNLESS OTHERWISE DIRECTED. SIGNS MAY REMAIN IN PLACE ONLY DURING DAYLIGHT HOURS.  
SIGNS ARE TO BE PLACED 6 TO 12 FEET OF THE PAVED SURFACE UNLESS OTHERWISE DIRECTED.  
ROAD WORK AHEAD SIGNS SHOWN AS EXAMPLES. ONE OF THE FOUR TYPE SIGNS WILL BE USED AS DIRECTED.

\* SIGNS IN THE MEDIAN ARE REQUIRED WHEN WORK OCCURS IN MEDIAN

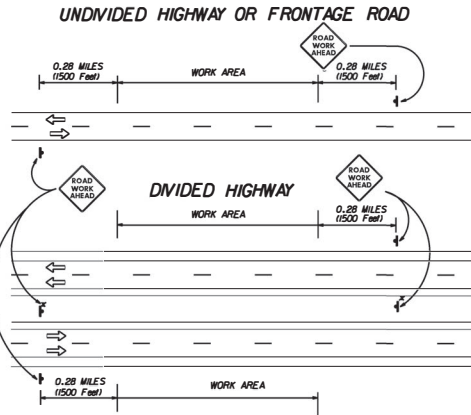

TRAFFIC CONTROL PLAN FOR WORK OFF OF THE PAVED SURFACE.

#### GENERAL NOTES FOR WORK ZONE SIGNS

- Contractor shall install and maintain signs in a straight and plumb condition and/or as directed by the Engineer.
  - Wooden sign posts shall be painted white.
  - Barricades shall NOT be used as sign supports.
  - Nails shall NOT be used to attach signs to any support.
  - All signs shall be installed in accordance with the plans or as directed by the Engineer. Signs shall be used to regulate, warn, and guide the traveling public safely through the work zone.
  - The Contractor may furnish either the sign design shown in the plans or in the "Standard Highway Sign Designs for Texas" (SHSD). The Engineer/Inspector may require the Contractor to furnish other work zone signs that are shown in the TMUTCD but may have been omitted from the plans. Any variation in the plans shall be documented by written agreement between the Engineer and the Contractor's Responsible Person. All changes must be documented in writing before being implemented. This can include documenting the changes in the Inspector's TxDOT diary and having both the Inspector and Contractor initial and date the agreed upon changes. The additional signs requested by the Engineer/Inspector shall not be subsidiary.
  - The Contractor shall furnish sign supports listed in the "Compliant Work Zone Traffic Control Device List" (CWZTCD). The Contractor shall install the sign support in accordance with the manufacturer's recommendations. If there is a question regarding installation procedures, the Contractor shall furnish the Engineer a copy of the manufacturer's installation recommendations so that the Engineer can verify the correct procedures are being followed.
  - The Contractor is responsible for sign installations and replacing signs with damaged or cracked substrates and/or damaged or marred reflective sheeting as directed by the Engineer/Inspector.
  - Identification markings may be shown only on the back of the sign substrate. The maximum height of letters and/or company logos used for identification shall be 1".
  - The Contractor shall replace damaged wood posts. New or damaged wood sign posts shall not be spliced.
- Duration of Work (as defined by the "Texas Manual on Uniform Traffic Control Devices" Part VII)**
- The Contractor is responsible for ensuring the sign support and substrate meets crashworthiness. For mowing operation all signs and supports are Short-term Duration for daytime work.
  - The Contractor shall furnish the sign sizes shown on this sheet or as directed by the Engineer.

#### SIGN SUBSTRATES

- The Contractor shall ensure that the sign substrate is allowed for the type of sign support that is being used. The CWZTCD lists each substrate that can be used on the different types and models of sign supports.
- "Mesh" type materials are NOT an approved sign substrate.
- All wooden individual sign panels fabricated from 2 or more pieces shall have one or more plywood cleat, 1/2" thick by 6" wide, fastened to the back of the sign and extending fully across the sign. The cleat shall be attached to the back of the sign using wood screws that do not penetrate the face of the sign panel. The screws shall be placed on both sides of the splice and spaced at 6" centers. The Engineer may approve other methods of splicing the sign faces.

#### REFLECTIVE SHEETING

- Reflectorized signs shall be constructed of sheeting meeting the color and retro-reflectivity requirements of DMS-8300 or DMS-8310. The DMS specifications can be accessed from the following web address:  
[http://manuals.dot.state.tx.us/80/dynweb/colmates/#Generic\\_CollectionView;cs=default;ts=default](http://manuals.dot.state.tx.us/80/dynweb/colmates/#Generic_CollectionView;cs=default;ts=default)
- White sheeting, meeting the requirements of DMS-8300 Type C (High Specific Intensity), shall be used for signs with white background and channelizing devices.
- Orange sheeting, meeting the requirements of DMS-8300 Type E (Fluorescent Prismatic), shall be used for signs with orange backgrounds.

#### SIGN LETTERS

- All sign letters and numbers shall be clear, and open rounded type uppercase alphabet letters as approved by the Federal Highway Administration (FHWA) and as published in the "Standard Highway Sign Design for Texas" manual. Signs, letters and numbers shall be of first class workmanship in accordance with Department Standards and Specifications.

#### REMOVING OR COVERING

- Signs should be removed or completely covered when not mowing.
- Duct tape or other adhesive material shall NOT be affixed to a sign face.
- Signs and supports shall be removed by the end of the day.

#### SIGN SUPPORT WEIGHTS

- Where sign supports require the use of weights to keep from turning over, the use of sandbags with dry cohesionless sand is recommended.
- The sandbags will be tied shut to keep the sand from spilling and to maintain a constant weight.
- Rock, concrete, iron, steel or other solid objects will not be permitted for use as sign support weights.
- Sandbags should weigh a minimum of 35 lbs and a maximum of 50 lbs.
- Sandbags shall be made of a durable material that tears upon vehicular impact.
- Rubber (such as tire inner tubes) shall NOT be used for sandbags.
- Rubber ballasts (such as those used with cones or edgeline channelizers) shall NOT be used as sign support weights.
- Sandbags shall only be placed along or laid over the base supports of the traffic control device and shall not be suspended above ground level or hung with rope, wire, chains or other fasteners. Sandbags shall be placed along the length of the skids to weigh down the sign supports.
- Sandbags shall NOT be placed under the skid and shall not be used to level sign supports placed on slopes.

#### CONTRACTOR REQUIREMENTS FOR MAINTAINING PERMANENT SIGNS WITHIN THE PROJECT LIMITS

Any sign, sign support or traffic control device that is struck or damaged by the Contractor or his/her construction equipment shall be replaced or repaired as soon as possible by the Contractor at the Contractor's expense.

Only pre-qualified products shall be used. A copy of the "Compliant Work Zone Traffic Control Devices List" (CWZTCD) describes pre-qualified products and their sources and may be obtained by contacting:

Standards Engineer  
 Traffic Operations Division - TE  
 Texas Department of Transportation  
 125 East 11th Street  
 Austin, Texas 78701-2483  
 Phone (512) 416-3120  
 Fax (512) 416-3299

Instructions to locate the "CWZTCD" on TxDOT website are:

Start at website - [www.dot.state.tx.us](http://www.dot.state.tx.us)  
 Click on "About TxDOT",  
 Click on "Organizational Chart",  
 Click on Traffic Operations Box,  
 Click on "Compliant Work Zone Traffic Control Devices",  
 Click on "View PDF".  
 This site is printable.



### ROADSIDE TRAFFIC CONTROL PLAN

SHEET 1 OF 1		RS-TCP-05		NOT TO SCALE	
FILE:	RSTCPOS	DN:	TXDOT	EN:	TXDOT
REVISED:	FEBRUARY 2005	DATE:	02	BY:	09
REVISED:	September 17, 2004	DATE:	02	BY:	09
REVISED:	FEBRUARY 2, 2005	DATE:	02	BY:	09
REVISED:	Sign Placement in ID	DATE:		BY:	
COUNTY:	PALO PINTO	CONTROL:	6440	SECTION:	15
JOB:		JOB:	001	HIGHWAY:	101 20 ETC.

DISCLAIMER: The use of this standard is governed by the "Texas Engineering Practice Act". No warranty of any kind is made by TXDOT for any purpose whatsoever. TXDOT assumes no responsibility for the conversion of this standard to other formats or for incorrect results or damages resulting from its use.

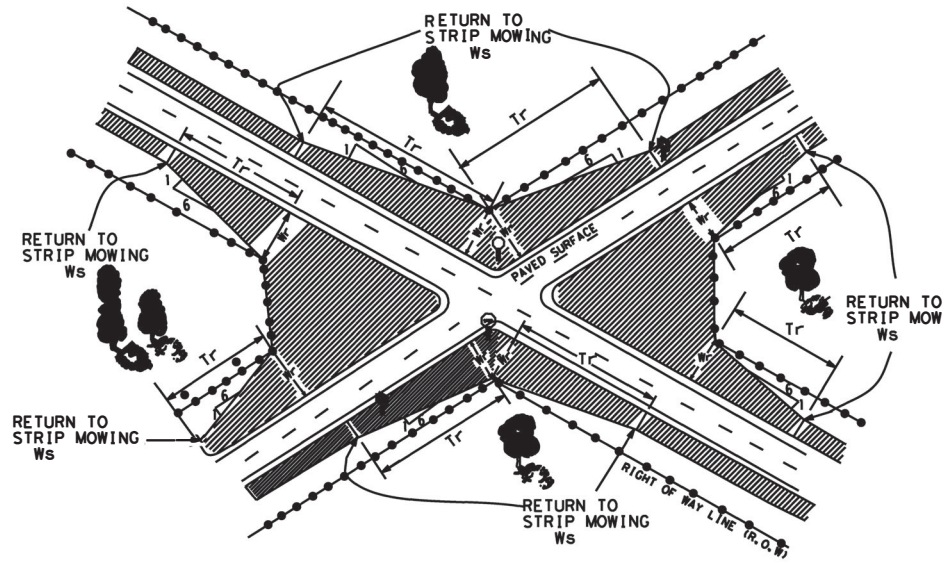

MOWING FOR SIGHT DISTANCE  
WITH TRANSITION FROM INTERSECTION  
BACK TO STRIP MOWING

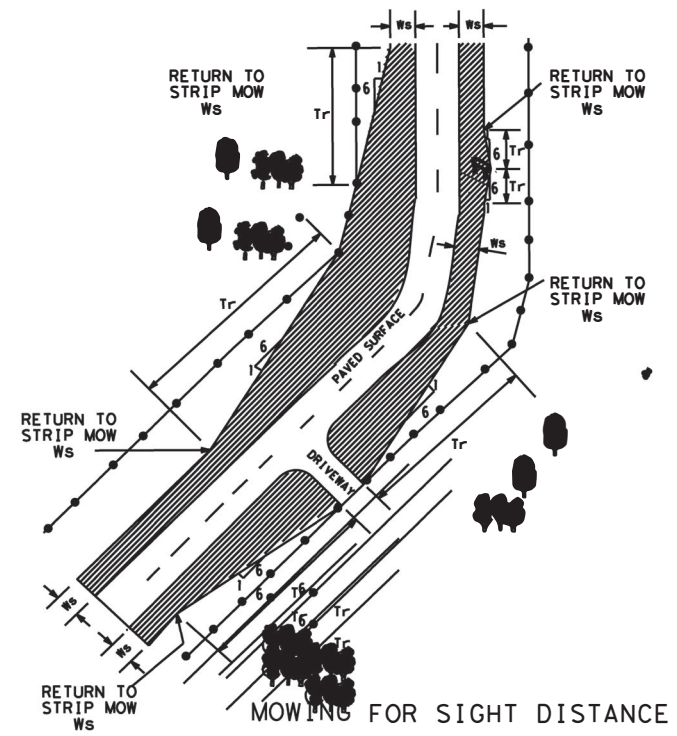

MOWING FOR SIGHT DISTANCE  
TRANSITIONS AT DRIVEWAYS,  
SIGNS, AND CURVES

**GENERAL NOTES:**

1. THE NORMAL WIDTH FOR STRIP MOWING IS 15' UNLESS OTHERWISE SHOWN ON THE PLANS.
2. MOW TO THE R.O.W. LINE IN FRONT OF BUSINESSES, RESIDENCES, CHURCHES, OR CULTIVATED FIELDS UNLESS OTHERWISE SHOWN ON THE PLANS.
3. TRANSITION FOR SIGHT DISTANCE TO R.O.W LINE OR AROUND SIGNS AS SHOWN ON THIS SHEET UNLESS OTHERWISE SHOWN ON THE PLANS.

	RIGHT OF WAY LINE
	MOWING LOCATION
<b>Wr</b>	R.O.W. WIDTH (AT START OF TRANSITION)
<b>Ws</b>	STRIP MOWING WIDTH
<b>Tr</b>	TRANSITION



STRIP MOWING NON-DIVIDED HIGHWAYS

STRIP-MOW-ND-04

SHEET 1 OF 1 NOT TO SCALE

FILE: SMOWN04.DGN	DN: TXDOT	CK: TXDOT	DW: TXDOT	CK+: TXDOT	NEG NO.: TXDOT
© TXDOT 2004	STATE DISTRICT	FEDERAL REGION	FEDERAL AID PROJECT		SHEET
REVISED: 5/18/2004	02	09			41
REVISED:	COUNTY		CONTROL SECTION	JOB	HIGHWAY
REVISED:	PALO PINTO		6440 15	001	IH 20 ETC.



DISCLAIMER  
 The use of this standard is governed by the "Texas Engineering Practice Act". No warranty of any kind is made by TxDOT for any purpose whatsoever. TxDOT assumes no responsibility for the conversion of this standard to other formats or for incorrect results or damages resulting from its use.

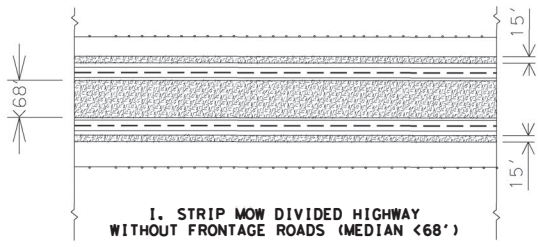

**I. STRIP MOW DIVIDED HIGHWAY WITHOUT FRONTAGE ROADS (MEDIAN < 68')**

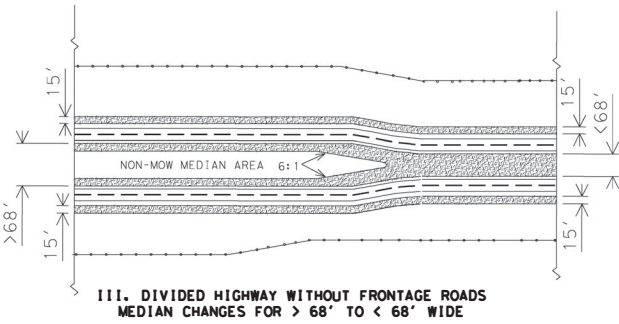

**III. DIVIDED HIGHWAY WITHOUT FRONTAGE ROADS MEDIAN CHANGES FOR > 68' TO < 68' WIDE**

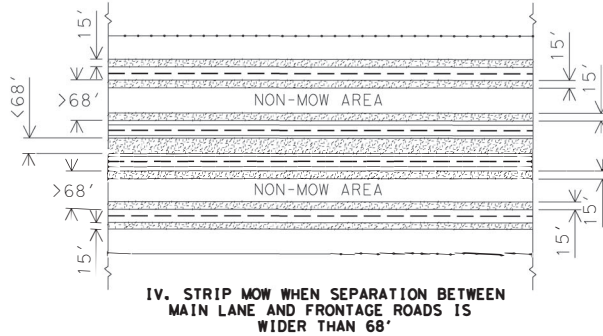

**IV. STRIP MOW WHEN SEPARATION BETWEEN MAIN LANE AND FRONTAGE ROADS IS WIDER THAN 68'**

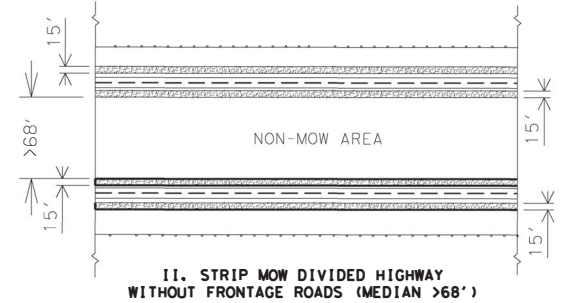

**II. STRIP MOW DIVIDED HIGHWAY WITHOUT FRONTAGE ROADS (MEDIAN > 68')**

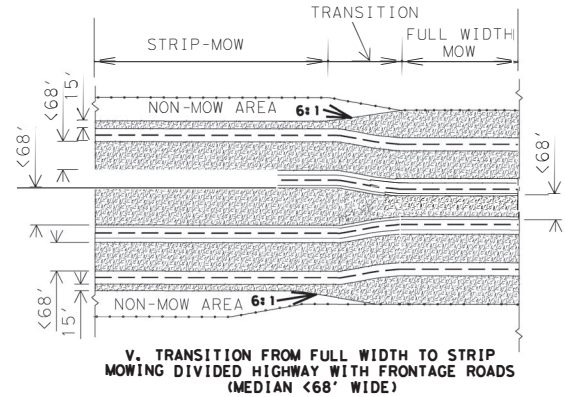



**V. TRANSITION FROM FULL WIDTH TO STRIP MOWING DIVIDED HIGHWAY WITH FRONTAGE ROADS (MEDIAN < 68' WIDE)**

**GENERAL NOTES:**

- MOW THE ENTIRE WIDTH OF MEDIANS AND OUTER SEPARATIONS (AREAS BETWEEN MAIN LANES, RAMPS, AND FRONTAGE ROAD) EXCEPT FOR NON-MOW AREAS.
- MOW FULL-WIDTH ALL MEDIANS AND OUTER SEPARATIONS 68' OR LESS FROM PAVEMENT EDGE TO PAVEMENT EDGE.
- FOR MEDIANS AND OUTER SEPARATIONS GREATER THAN 68' MOW A 15' ALONG EACH PAVEMENT EDGE.
- NON-MOW AREAS IN MEDIANS & OUTER SEPARATIONS WILL BE CONSIDERED THE AREA IN MEDIANS AND OUTER SEPARATIONS GREATER THAN 68' BETWEEN THE 15' STRIP MOW AREAS.
- OTHER NON-MOW AREA'S WILL BE SHOWN ELSEWHERE ON PLANS OR MARKED ON THE RIGHT OF WAY.

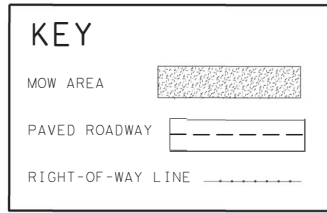
LEVELS DISPLAYED
1 2 3 4 5 6 7 8 9 10 11 12 13 14 15 16 17 18 19 20 21 22 23 24 25 26 27 28 29 30 31 32 33 34 35 36 37 38 39 40 41 42 43 44 45 46 47 48 49 50 51 52 53 54 55 56 57 58 59 60 61 62 63



 Texas Department of Transportation  
 Maintenance Division  
 Standard Plans

STRIP MOWING  
 (DIVIDED HIGHWAYS)  
 STRIP-MOW-D-04

SHEET 1 OF 1 NOT TO SCALE

FILE: SMOOW04.DGN	DN: TXDOT	CK: TXDOT	DW: TXDOT	CK: TXDOT	NEG NO.: TXDOT
© TxDOT JUNE 2004		STATE DISTRICT	FEDERAL REGION	FEDERAL AID PROJECT	
REVISED: 6/03/2004	02	09			SHEET 42
REVISED:	COUNTY		CONTROL SECTION	JOB	HIGHWAY
REVISED:	PALO PINTO		6440 15	001	SH 20 ETC.