

INDEX OF SHEETS

SHEET NO.	DESCRIPTION
1	TITLE SHEET
2	ESTIMATE & QUANTITY SHEET
3A-3I	GENERAL NOTES
4	PROJECT LIMITS
5	SUMMARY SHEET
6-7	TRB-15(1) (DAL) AND TRB-15(2)
8	RSTCP-05
9-20	BC(1)-21 THRU BC(12)-21
21	WZ(RS)-16
22-24	TCP(1-3)-18 THRU TCP(1-5)-18
25-30	TCP(2-1)-18 THRU TCP(2-6)-18
31	TCP(5-1)-18
32-36	TCP(6-1)-12 THRU TCP(6-5)-12
37-38	TCP(6-8)-14 THRU TCP(6-9)-14

STATE OF TEXAS  
DEPARTMENT OF TRANSPORTATION  
PLANS OF PROPOSED  
HIGHWAY ROUTINE MAINTENANCE CONTRACT

GRAPHICS FILE		MAINTENANCE PROJECT NO.		SHEET NO.
DN		RMC-639346001		1
CHECKED	STATE	STATE DIST.	COUNTY	
DN	TEXAS	DALLAS	DALLAS	
CHECKED	CONT.	SECT.	JOB	HIGHWAY NO.
NP	6393	46	001	IH0030

**TYPE OF WORK:**

TREE TRIMMING AND BRUSH REMOVAL

PROJECT NO. : RMC-639346001

HIGHWAY : IH0030

LIMITS : VARIOUS ROADWAYS IN THE EAST DALLAS COUNTY MAINTENANCE SECTIONS

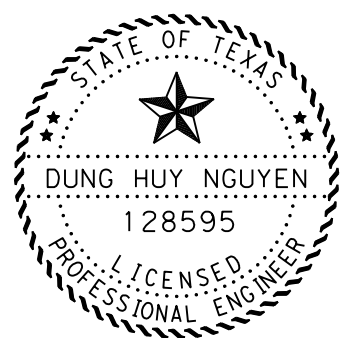

THE STANDARD SHEETS SPECIFICALLY IDENTIFIED ABOVE HAVE BEEN SELECTED BY ME OR UNDER MY RESPONSIBLE SUPERVISION AS BEING APPLICABLE TO THIS PROJECT.

*Dung Nguyen*, PE      10/14/2021  
DATE

DALLAS COUNTY  
SCALE 0 1 2 3 4 MILES  
DALLAS DISTRICT

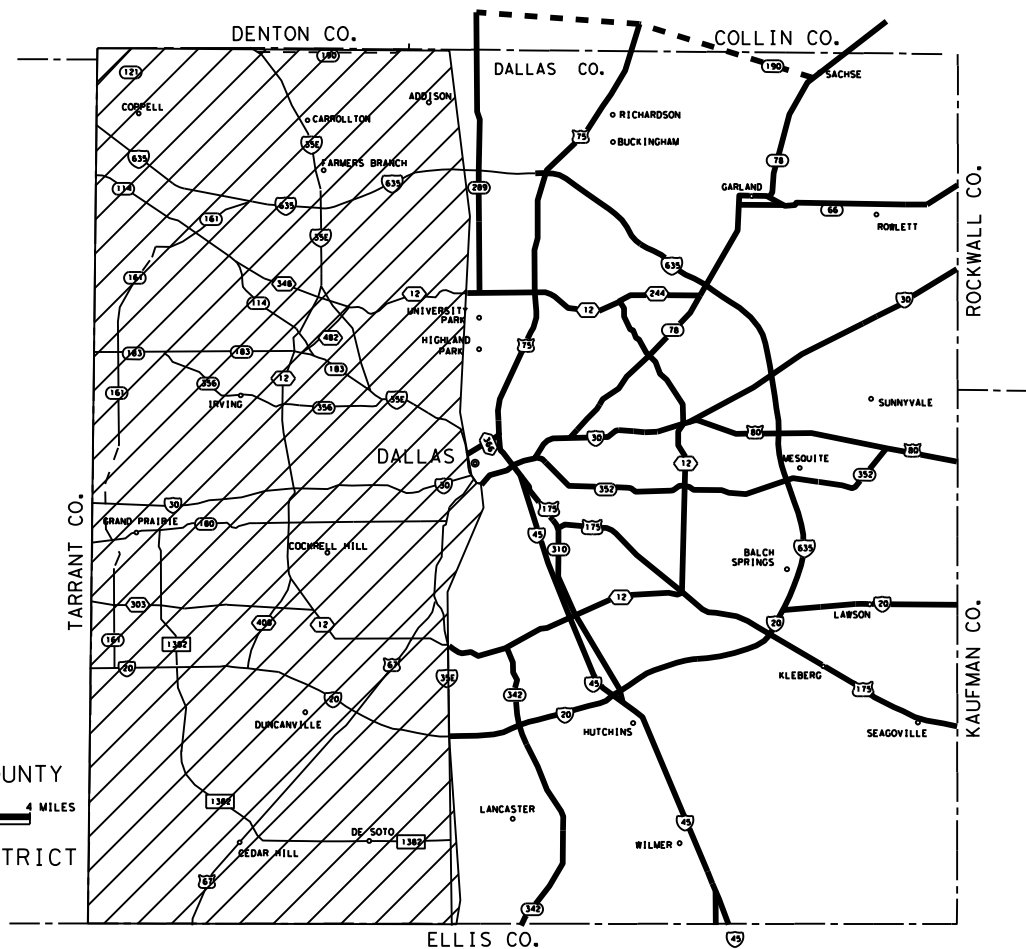

Texas Department of Transportation

RECOMMENDED FOR LETTING

DocuSigned by:

*Ann W., P.E.*

10/18/2021

01F881A42AA240C...

AREA ENGINEER

RECOMMENDED FOR LETTING

DocuSigned by:

*David Momen, P.E.*

1/5/2022

72258D0350B94E4...

DISTRICT MAINTENANCE ENGINEER

RECOMMENDED FOR LETTING

DocuSigned by:

*JEFFREY BUSH*

1/7/2022

345B765EB03F406...

DIRECTOR OF OPERATIONS

LEVELS DISPLAYED	
1	
2	
3	
4	

SPECIFICATIONS ADOPTED BY THE TEXAS DEPARTMENT OF TRANSPORTATION NOVEMBER 1, 2014 AND SPECIAL SPECIFICATION ITEMS INCLUDED IN THE CONTRACT SHALL GOVERN ON THIS PROJECT.

© by Texas Department of Transportation 2021 : all rights reserved



# Estimate & Quantity Sheet

CONTROLLING PROJECT ID 6393-46-001

DISTRICT Dallas  
HIGHWAY IH0030

COUNTY Dallas

CONTROL SECTION JOB				6393-46-001		TOTAL EST.	TOTAL FINAL
PROJECT ID				A00183094			
COUNTY				Dallas			
HIGHWAY				IH0030			
ALT	BID CODE	DESCRIPTION	UNIT	EST.	FINAL		
	500-6001	MOBILIZATION	LS	1.000		1.000	
	502-6001	BARRICADES, SIGNS AND TRAFFIC HANDLING	MO	3.000		3.000	
	752-6001	TREE TRIMMING	MI	34.000		34.000	
	752-6002	BRUSH REMOVAL	MI	17.000		17.000	
	752-6004	TREE TRIMMING / BRUSH REMOVAL(CHANNELS)	AC	25.600		25.600	
	752-6005	TREE REMOVAL (4" - 12" DIA)	EA	10.000		10.000	
	752-6006	TREE REMOVAL (12" - 18" DIA)	EA	5.000		5.000	
	752-6007	TREE REMOVAL (18" - 24" DIA)	EA	2.000		2.000	
	752-6008	TREE REMOVAL (24" - 30" DIA)	EA	2.000		2.000	
	752-6014	STUMP REMOVAL	EA	20.000		20.000	
	6185-6002	TMA (STATIONARY)	DAY	31.000		31.000	

**Project Number:** RMC-639346001

**Control:** 6393-46-001

**County:** Dallas

**Highway:** IH0030

**GENERAL NOTES:**

**General:**

This project consists of performing "Tree Trimming and Brush Removal" on various roadways as detailed on the Summary Sheet in the East Dallas County Maintenance Sections.

Sequence of work will be approved.

The Department reserves the right to revise schedule as it deems necessary.

Provide and maintain a dedicated email address for receipt of work orders and correspondence throughout the term of this contract. Acknowledgement of emailed work order/callouts is required no more than 12 hr. from notification.

Contractor's attention is called to the fact that all adjoining pavement sections will be protected during all phases of construction and any damages incurred due to Contractor's operation will be repaired and replaced at the Contractor's expense.

Each contract awarded by the Department stands on its own as such, is separate from other contracts. A Contractor awarded multiple contracts, must be capable and sufficiently staffed to concurrently process any or all contracts at the same time.

Required minimum centerline miles per working day will be 1 centerline mile for Tree Trimming and Brush Removal, 5 trees for tree removal, and 1 acre for Tree Trimming/Brush Removal (Channels).

Coordinate work through:

Terry Blocker  
4777 E. Hwy 80  
Mesquite, Texas 75150  
214-320-6234

Bids will be received at 4777 E. Hwy 80, Mesquite, Texas 75150-6643.

Contractor questions on this project are to be emailed to the following individuals:

Terry Blocker      [Terry.Blocker@txdot.gov](mailto:Terry.Blocker@txdot.gov)  
Nathan Petter      [Nathan.Petter@txdot.gov](mailto:Nathan.Petter@txdot.gov)

Contractor questions will only be accepted through email to the above individuals.

**Project Number:** RMC-639346001

**Control:** 6393-46-001

**County:** Dallas

**Highway:** IH0030

All Contractor questions will be reviewed by the Engineer. Once a response is developed, it will be posted to TxDOT's Public FTP at the following address:

[https://ftp.dot.state.tx.us/pub/txdot-info/Pre-letting Responses/](https://ftp.dot.state.tx.us/pub/txdot-info/Pre-letting%20Responses/)

All questions submitted that generate a response will be posted through this site. The site is organized by District, Project Type (Construction or Maintenance), Letting Date, CCSJ/Project Name.

Attention is directed to the possible presence of underground utilities owned by the Texas Department of Transportation (irrigation, signal, illumination and surveillance, communication, and control) on the right of way. Call the Department for locates at 214-320-6682 and 214-320-6205 48 hr. in advance of excavation. Contact the appropriate department of the local city or town a minimum of 48 hr. in advance of excavation.

If overhead or underground power lines need to be de-energized, contract the electrical service provider to perform this work. Cost associated with de-energizing the power lines or other protective measures required are at no expense to the Department.

If working near power lines, comply with the appropriate sections of Texas State Law and Federal Regulations relating to the type of work involved.

**Item 2 – Instructions to Bidders:**

This project includes plan sheets that are not part of the bid proposal.

Order plans from any Reproduction Company listed at:

[http://www.dot.state.tx.us/business/contractors\\_consultants/repro\\_companies.htm](http://www.dot.state.tx.us/business/contractors_consultants/repro_companies.htm)

View or download plans at:

<http://www.dot.state.tx.us/business/plansonline/plansonline.htm>

**Item 3 – Award and Execution of Contract:**

This contract is Site Specific.

After written notification, work will be prosecuted to completion

The work order letter will include all roadways contained on the Summary Sheet.

**Project Number:** RMC-639346001

**Control:** 6393-46-001

**County:** Dallas

**Highway:** IH0030

Notification to perform “Non-Site Specific” work at locations not presented on the Summary Sheet will be in writing.

“Non-Site Specific” minimum per notification will be \$1000.

When “Non-Site Specific” locations are shown on the plans, no additional compensation will be made for re-mobilization or Item 502-Barricades, Signs, and Traffic Handling.

Re-mobilize within 30 calendar days of written notification when Non-Site Specific locations are requested.

**Item 7 – Legal Relations and Responsibilities:**

Pre-construction safety meeting will be conducted with Contractor’s personnel prior to work beginning on a continuously prosecuted contract or before each callout work request.

Attendance of this meeting will not be paid directly but considered subsidiary to the various bid items.

Holiday restrictions – the Engineer may decide that no lane closures or construction operations will be allowed during the restricted periods listed in the following holiday schedule. TxDOT has the right to lengthen, shorten, or otherwise modify these restricted periods as actual, or expected, traffic conditions may warrant. Working days will not be charged for these restricted periods. No additional compensation will be allowed for these restricted closures (i.e., overhead, delays, stand-by, barricades or any other associated cost impacts).

- New Year’s Eve and Day (noon on December 31 thru 10 P.M. January 1)
- Easter Holiday weekend (noon on Friday thru 10 P.M. Sunday)
- Memorial Day weekend (noon on Friday thru 10 P.M. Monday)
- Independence Day (noon on July 3 thru 10 P.M. on July 5)
- Labor Day weekend (noon on Friday thru 10 P.M. Monday)
- Thanksgiving Holiday (noon on Wednesday thru 10 P.M. Sunday)
- Christmas Holiday (noon on December 23 thru 10 P.M. December 26)

Holiday restrictions for Independence Day, Thanksgiving Holiday, and the Christmas Holiday may be extended for the “week of” due to the nature of work being performed and the work location at the discretion of the Engineer for safety of the traveling public.

Event Restrictions – No Lane Closures that restricts or interferes with traffic shall be allowed for the regional events set forth below. This affects IH 30, IH 345, SS 366, SH 352 and IH 45. TxDOT has the right to lengthen, shorten, or otherwise modify these restrictions as actual traffic conditions may warrant. TxDOT also has the right to modify the list of major events as they are added, renamed, rescheduled, or as warranted.

**Project Number:** RMC-639346001

**Control:** 6393-46-001

**County:** Dallas

**Highway:** IH0030

- State Fair of Texas (no lane closures after 6:00am on Fridays through 9:00pm on Sundays; no full closures for any direction of any facility from opening day through the closing day)
- The University of Texas vs. University of Oklahoma football game (no lane closures beginning four hours prior to the event and ending three hours following event completion)
- The First Responder Bowl (no lane closures beginning 3 hr. prior to the event and ending 2 hr. following the event completion).
- Dallas Mavericks Home Games (no lane closure beginning two hours prior to the event and ending one half-hour following event commencement with no full lane closures considered until two hours following event completion)
- Dallas Stars Home Games (no lane closure beginning two hours prior to the event and ending one half-hour following event commencement with no full lane closures considered until two hours following event completion)
- Texas Rangers Home Games (no lane closure beginning two hours prior to the event and ending one half-hour following event commencement with no full lane closures considered until two hours following event completion)
- Dallas Cowboys Home Games (no lane closure beginning two hours prior to the event and ending one half-hour following event commencement with no full lane closures considered until two hours following event completion)
- Major Events at the American Airline Center, Globe Life Park in Arlington, AT&T Stadium with expected attendance exceeding 15,000 (no lane closures beginning two hours prior to event and ending one half-hour following event commencement with no full closures considered until two hours following event completion.)
- Major Downtown Dallas Events (restrictions will be considered on a case-by-case basis) This category could include, but is not limited to, parades for sports championships, major political events, major Art District Events, and large athletic events such as marathons

**Item 8 – Prosecution and Progress:**

Contract days will be charged in accordance with Section 8.3.1.5., Contract term is 365 days.

Call-out work requests will be issued for each site location. Allowable working days for each site location will be shown in the plans. Working days will be charged in accordance with 8.3.1.4 “Standard Workweek”.

Liquidated damages will be charged for each working day exceeding the time allowed in the work order letter.

The Lane Closure Assessment Fee is shown on the following table. The fee applies to the Contractor for closures or obstructions that overlap into restricted hour traffic for each hour or portion thereof, regardless of the duration of the lane closure or obstruction.



Project Number: RMC-639346001

Control: 6393-46-001

County: Dallas

Highway: IH0030

**Table 1**  
**Lane Closure Assessment Fee Table**

Roadway	Amount Per Lane Per Hour
BI 45J	\$200
IH 20	\$2,500
IH 30	\$3,500
IH 345	\$3,500
IH 45	\$1,500
IH 635	\$4,500
US 75	\$6,500
US 80	\$1,500
US 175	\$1,500
SH 66	\$500
SH 78	\$500
SH 190	\$500
SH 289	\$1,000
SH 310	\$200
SH 342	\$400
SH 352	\$400
SS 244	\$500
SS 366	\$4,000
SL 12	\$1,500

Contractor will submit a bar chart or CPM chart for progress of schedule. Present work to begin no later than 7 calendar days from the work order letter unless otherwise approved.

Perform work during the shaded months presented in the "Schedule of Work" Table.

**TABLE 2**  
**SCHEDULE OF WORK**

	JAN	FEB	MAR	APR	MAY	JUN	JUL	AUG	SEP	OCT	NOV	DEC
Site Specific Work												
Non-Site Specific Work												

Project Number: RMC-639346001

Control: 6393-46-001

County: Dallas

Highway: IH0030

For Site Specific items, work will begin no later than 7 calendar days from issuance of the work order letter and continuously processed to completion unless otherwise approved.

For Site Specific items, it is of utmost importance that work be prosecuted to completion within the timeframe noted in the contract. Liquidated Damages will be assessed for work performed outside the identified Site Specific Schedule of Work.

For Non-Site Specific items, Contractor may prosecute work at any time only if locations are known and approved by the Engineer. Otherwise, work for Non-Site Specific locations is expected to take place within the identified timeline shown on this "Schedule of Work" Table.

**Item 9 – Measurement and Payment:**

Do not obtain law enforcement personnel without requesting in writing 48 hr. prior to need and the Engineer's written approval. The Department may compensate the Contractor for providing full time, off-duty, uniformed, law enforcement personnel, and patrol car. The law enforcement personnel may be required for assistance with traffic control for lane or ramp closures or other situations that dictate the need for law enforcement officers as directed. Off-duty law enforcement personnel will have transportation jurisdiction and full police powers. Law enforcement personnel will show proof of certification by the Texas Commission on Law Enforcement (TCOLE). This will be paid under "Force Account – Law Enforcement Personnel". TxDOT Form 318 will be utilized.

Payment for police officer hours under force account method will not exceed the duration of the lane closure. Time will begin when set up operations commence and end when the closure is removed.

**Item 500 – Mobilization:**

Mobilization is lump sum.

**Item 502 – Barricades, Signs, and Traffic Handling:**

Provide traffic control in compliance with the latest edition of the "Texas Manual on Uniform Traffic Control Devices" (TMUTCD), the "Traffic Control Standard Sheets" (TCSS), and as directed.

Perform work Monday through Friday during daylight hours. Do not begin work until 30 minutes after sunrise and cease operations 30 minutes before sunset.

**Project Number:** RMC-639346001

**Control:** 6393-46-001

**County:** Dallas

**Highway:** IH0030

If closing a lane is necessary, closure times will be Monday through Friday, 9 A.M. to 3:30 P.M. Close no more than one lane at a time, unless otherwise approved. Provide proposed lane closure information to the Engineer by 1 P.M. on the day prior to the proposed closures. Furnish information for Monday closures or closures following a national or state holiday on the last office workday prior to the closures. Do not close lanes if the above reporting requirements have not been met.

Nighttime and weekend work will be allowed with prior approval, except for emergency work.

Maximum length of lane closure will be 2 miles.

Traffic Control Plans with a lane closure causing backups of 20 minutes or greater in duration will be modified by the Engineer.

Erect barricades and signs in locations not obstructing the traveling public's view of the normal roadway signing or necessary sight distance.

Provide sufficient and qualified staff and equipment to revise the traffic control as directed.

Trailer all slow moving vehicles (designed to operate 25 mph or less) crossing freeway main lanes.

When moving unlicensed equipment on or across any pavement or public highways, protect the pavement from all damage using an acceptable method.

Equipment and materials will not be left within 30 ft. of the travel lane during non-working hours.

The work performed, materials furnished and all labor, tools, and equipment necessary to complete the work for Non-Site Specific locations under this Item will not be measured or paid for directly but will be considered subsidiary to the various bid items of this contract.

The "Force Account – Safety Contingency" has been established for this project and is intended to be utilized for work zone enhancements to improve the effectiveness of the Traffic Control Plan that could not be foreseen in the project planning and design stage. These enhancements will be mutually agreed upon by the Engineer and the Contractor's Responsible Person based on weekly or more frequent traffic management reviews on the project. The Engineer may choose to use existing bid items if it does not slow the implementation of enhancement.

**Item 752 – Tree and Brush Removal:**

Avoid pruning oak trees between March 15 and the end of June to limit the potential spread of Oak Wilt disease.

**Project Number:** RMC-639346001

**Control:** 6393-46-001

**County:** Dallas

**Highway:** IH0030

Trees located in front of a residence or a business will be pruned or trimmed as directed.

Tree Removal – Cut all trees as close to the ground as possible but no higher than 3 in. above the ground level until the stump can be removed according to the plans. Department will mark the trees to be removed with fluorescent orange paint.

Do not use a telescopic side boom rotary mower.

Brush Removal – Remove all brush at culverts, headwalls, wingwalls, guardrail, cable barrier, riprap and as directed. Trees less than 4 in. diameter are considered brush and are to be removed. Saplings and brush will not be marked with fluorescent orange paint.

Remove and dispose of or mulch all dead fall (trees and/or limbs already fallen to the ground) from within the limits of the right of way. This will not be paid for directly but will be considered subsidiary to this item.

Operate equipment (chipper and/or screen) to ensure at least 90% of wood chips left on the right of way are smaller than 2 in. in size (length and width). Keep cutter bar and blades sharp to ensure limbs are not shredded.

Prune all trees at the right of way line to a minimum 18 ft. vertical face measured from the adjacent natural ground. If limbs encroach pavement after pruning, prune as directed.

All stumps will be removed before proceeding to a new location.

Stump removal pay item is for stumps where others previously removed the tree.

Do not use any chemical agents to aid in the deterioration or removal of the stump.

Trees blocking signs will be trimmed as directed.

Burning of brush will not be permitted. Cleanup will be continuously and concurrently with pruning, trimming, and removal operations.

Unless otherwise approved, all trees, limbs, and brush that are cut in 1 day will be picked up and moved off the right of way the same day.

All driveways, walkways, paths, right of way, and roadways will be left clean at the end of each workday.

For channel work, no heavy equipment will be allowed below the ordinary high water mark. Only hand clearing will be allowed for brush removal or as directed.

**Project Number:** RMC-639346001

**Control:** 6393-46-001

**County:** Dallas

**Highway:** IH0030

**Item 6185 – Truck Mounted Attenuator (TMA) and Trailer Attenuator (TA):**

The total number of truck mounted attenuators (TMA) required when utilizing the traffic control standards are shown in the tables below.

TCP 1 Series	Scenario		Required TMA/TA	
(1-3)-18	A	B	1	2
(1-4)-18 / (1-5)-18			1	

TCP 2 Series	Scenario		Required TMA/TA	
(2-1)-18 / (2-2)-18 / (2-4)-18 / (2-5)-18 / (2-6)-18	All		1	
(2-3)-18	A	B	1	2

TCP 5 Series	Scenario		Required TMA/TA
(5-1)-18	A	B	1

TCP 6 Series	Scenario		Required TMA/TA	
(6-1)-12	A	B	1	2
(6-2)-12 / (6-3)-12	All		1	
(6-4)-12	A	B	1	2
(6-5)-12	A	B	1	2
(6-8)-14 / (6-9)-14	All		1	

Shadow vehicles equipped for truck mounted attenuators (TMA) for mobile and stationary operations must be available for use at any time as determined by the Engineer.

The Contractor will be responsible for determining if one or more of these operations will be ongoing at the same time to determine the total number of TMA needed for the project for those times per plan requirements. Additional TMAs used that are not specified in the plans in which the Contractor expects compensation will require prior approval from the Engineer.

When TMA's are paid by the hour or day, "ready for operation" is defined as all equipment, material, personnel, etc. are present on the project ready to begin work.



DATE: 12/14/2021 TIME: 1:15:32 PM FILE: T:\DALAO\DALNEAO\Maint. Contracts\2022 RMC Folder\Tree Trimming and Brush Removal\6393-46-001\_East\_Tree Trimming & Brush Removal\

REF NO	LOCATION	PHYSICAL LIMITS	TEXAS REFERENCE MARKERS	ADT	752 6001	752 6002	752 6004	752 6005	752 6006	752 6007	752 6008	752 6014	
					TREE TRIMMING	BRUSH REMOVAL	TREE TRIMMING / BRUSH REMOVAL (CHANNELS)	TREE REMOVAL (4" - 12" DIA)	TREE REMOVAL (12" - 18" DIA)	TREE REMOVAL (18" - 24" DIA)	TREE REMOVAL (24" - 30" DIA)	STUMP REMOVAL	*DAYS ALLOWED TO COMPLETE
					MI	MI	AC	EA	EA	EA	EA	EA	DAYS
NORTHEAST MAINTENANCE SECTION													
1	US 75	Walnut Hill To Galatyn	264 - 256		6								6
2	SH 66	Lake Ray Hubbard Bridge	598-599	40,337	1								1
3	SH 66	Lake Ray Hubbard Bridge	601-602	40,337		1							1
4	SS 366	IH 35E To US 75	585-587	203,315	2								2
5	IH 30	Malcom X to Jim Miller Rd	47-52		5								5
6	IH 30	IH 345 Interchange	48-47	166,349	4								4
SOUTHEAST MAINTENANCE SECTION													
7	IH 45	From SH310 to SL12	275-279	59,237	4	4							8
8	IH45	5 Mile Creek	277	86,981			13.5						14
9	US 80	From Collins Rd to Kaufman CL	267-275	86,981	5	5							10
10	US 80	WB Ramp to SL12	661	662	1	1							2
11	IH635	South Mesquite Creek	5	71,869			1.6						2
12	SH310	From Youngblood to IH20	273-274	54,242	1	1							2
13	SH310	Newton Creek	274	77,226			1.5						2
14	SH310	5 Mile Creek	273	77,226			0.5						1
15	IH20	Hickory Creek	481				7.5						8
NON-SITE SPECIFIC					5	5	1	10	5	2	2	20	
NON-SITE SPECIFIC LOCATIONS													
<b>PROJECT TOTALS</b>					<b>34</b>	<b>17</b>	<b>25.6</b>	<b>10</b>	<b>5</b>	<b>2</b>	<b>2</b>	<b>20</b>	<b>68</b>

\* TOTAL WORKING DAYS PER REFERENCE NO. (SITE LOCATION) TO COMPLETE THE WORK.



**SUMMARY SHEET**

DESIGN DN	FED. RD. DIV. NO.	MAINTENANCE PROJECT		HIGHWAY NO.
GRAPHICS DN	6	RMC-639346001		IH0030
CHECK NP	STATE	DISTRICT	COUNTY	SHEET NO.
CHECK DN	TEXAS	DALLAS	DALLAS	5
	CONTROL	SECTION	JOB	
	6393	46	001	

DISCLAIMER: The use of this standard is governed by the "Texas Engineering Practice Act". No warranty of any kind is made by TxDOT for any purpose whatsoever. TxDOT assumes no responsibility for the conversion of units or the accuracy of any information derived from this standard. TxDOT reserves the right to modify this standard without notice.

10/14/2021 11:02:28 AM  
T:\DALAO\DALNEAO\Maint. Contracts\2022 RMC Folder\Tree Trimming and Brush Removal\TRB-15(1)(DAL).dgn

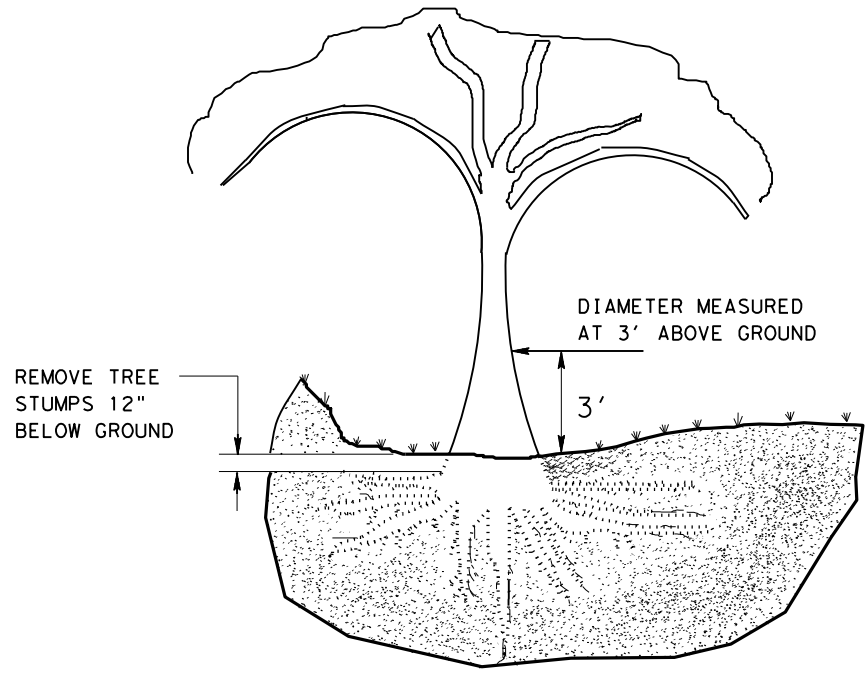

TREE REMOVAL

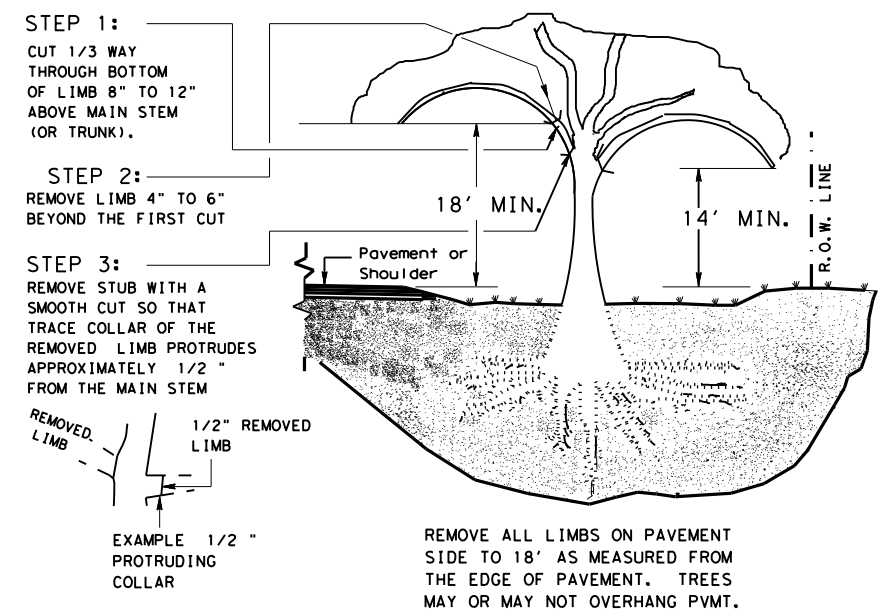

TREE TRIMMING

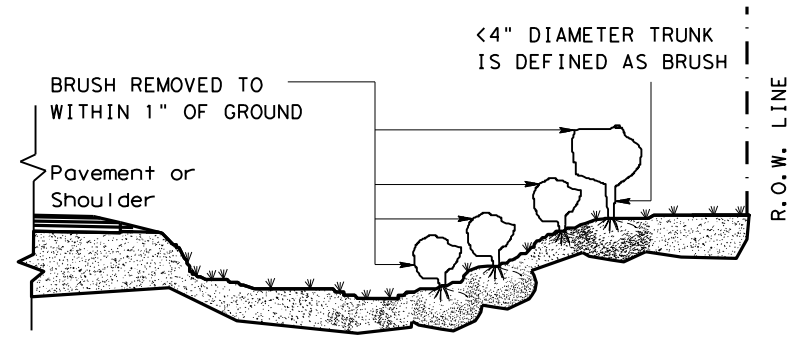
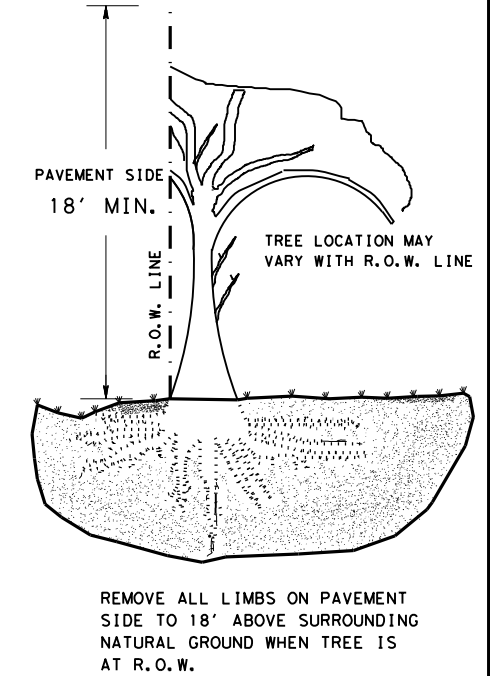
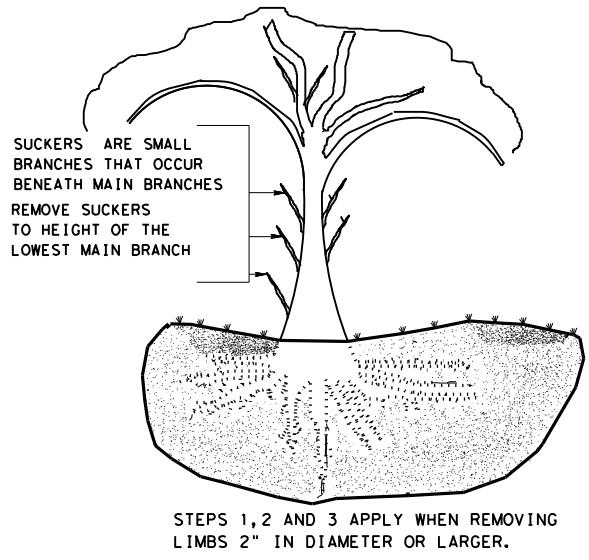

BRUSH REMOVAL

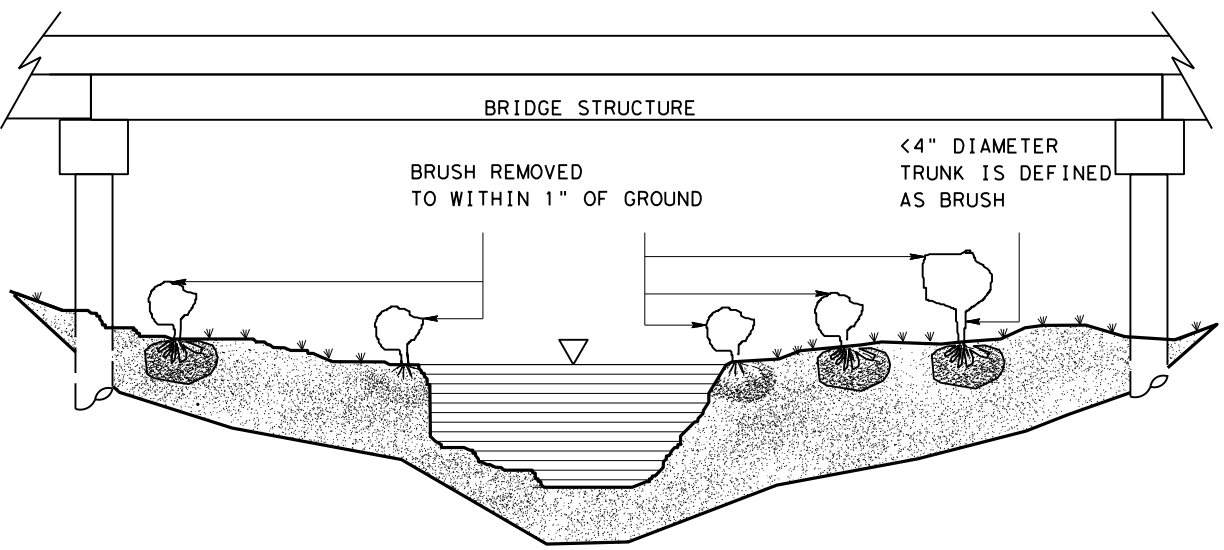

BRUSH REMOVAL UNDER BRIDGE AND IN CHANNEL

GENERAL NOTES:

TREE TRIMMING

1. TRIM AND REMOVE ALL TREE LIMBS ON THE PAVEMENT SIDE OF THE TRUNK 18' ABOVE THE PAVEMENT OR BRIDGE DECK ELEVATION, OVER HANGING THE ROADWAY OR NOT, UNLESS OTHERWISE SHOWN ON THE PLANS.
2. TRIM AND REMOVE ALL TREE LIMBS BETWEEN THE TRUNK AND R.O.W. LINE 14' ABOVE NATURAL GROUND, TERRAIN OR OTHER STRUCTURE ELEVATION, UNLESS OTHERWISE SHOWN ON THE PLANS.

TREE REMOVAL

3. FOR TREES MARKED FOR REMOVAL, THE DIAMETER OF TREES ARE DETERMINED BY MEASUREMENT OF THE TRUNK CIRCUMFERENCE 3' ABOVE THE GROUND. TREES WITH TRUNKS OF LESS THAN 4" DIAMETER ARE CONSIDERED TO BE BRUSH. TREES WITH MULTIPLE TRUNKS AT THE POINT OF MEASUREMENT ARE MEASURED AND PAID FOR SEPARATELY.
4. MEASUREMENTS FOR PAYMENT ARE PRESENTED IN TABLE 1: RANGE FOR PAY ITEMS.

TABLE 1 TREE TRUNK SIZE FOR TREE REMOVAL PAYMENT				
PAY ITEM	RANGE FOR PAY ITEMS			
	TRUNK DIAMETER *		TRUNK CIRCUMFERENCE	
	LOWER LIMIT IS GREATER THAN	UPPER LIMIT IS LESS THAN OR EQUAL TO	LOWER LIMIT IS GREATER THAN	UPPER LIMIT IS LESS THAN OR EQUAL TO
752 6005	4	12	12 1/2	37 1/2
752 6006	12	18	37 1/2	56 1/2
752 6007	18	24	56 1/2	75 1/2
752 6008	24	30	75 1/2	94
752 6009	30	36	94	113
752 6010	36	42	113	132
752 6011	42	48	132	151
752 6012	48	60	151	188 1/2
752 6013	60	72	188 1/2	226
752 6019	72	84	226	264
	84	GREATER THAN 84	264	NOT APPLICABLE

\*SEE GENERAL NOTE #3.



TREE AND BRUSH REMOVAL  
TRB-15(1)(DAL)

FILE:	DW: JEO	CK: LJB	DW: JEO	CK:
© TxDOT MARCH 2017 REVISED TO CLARIFY WORK AT THE R.O.W. AND GENERAL NOTE 1.	CONT 6393	SECT 46	JOB 001	HIGHWAY IH0030
	DIST 18	COUNTY DALLAS	SHEET NO. 6	





DISCLAIMER  
The use of this standard is governed by the "Texas Engineering Practice Act". No warranty of any kind is made by TxDOT for any purpose whatsoever. TxDOT assumes no responsibility for the conversion of this standard to other formats or for incorrect results or damages resulting from its use.

1	2	3	4	5	6	7	8	9	10	11	12	13	14	15	16
17	18	19	20	21	22	23	24	25	26	27	28	29	30	31	32
33	34	35	36	37	38	39	40	41	42	43	44	45	46	47	48
49	50	51	52	53	54	55	56	57	58	59	60	61	62	63	

## EXAMPLES OF SIGN SUPPORTS

See the CWZTCD for the type of sign substrate that can be used for each approved sign support.

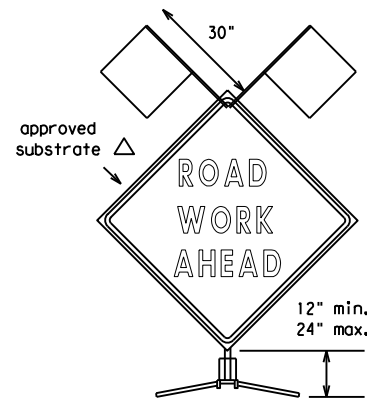

Flags as required by Engineer or as shown on plans

### SHORT TERM DURATION, DAYTIME USE ONLY PORTABLE SIGN SUPPORTS

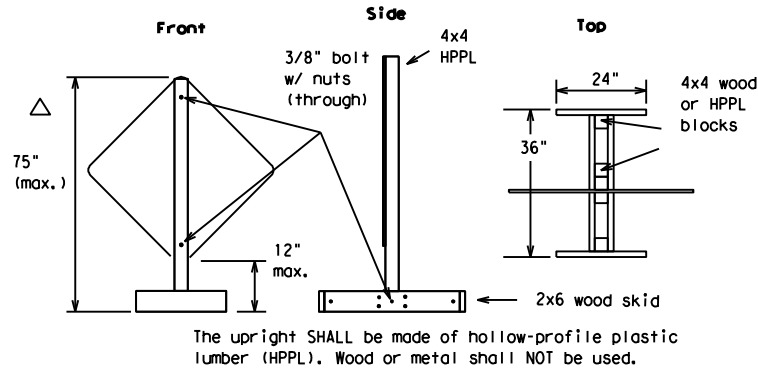

The upright SHALL be made of hollow-profile plastic lumber (HPPL). Wood or metal shall NOT be used.  
1 Foot Mounting Height

Attachment to wooden supports will be by bolts and nuts or screws. Use TxDOT's or manufacturer's recommended procedures for attaching sign substrates to other types of sign supports.

**Nails will NOT be allowed.**

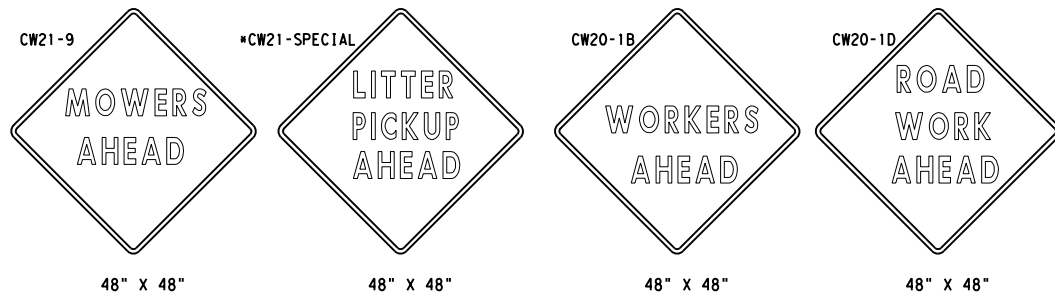

SIGN IN ACCORDANCE WITH THE TEXAS MANUAL ON UNIFORM TRAFFIC CONTROL DEVICES FOR STREETS AND HIGHWAYS

MOWERS AHEAD SIGNS ARE USED FOR MOWING OPERATIONS.

LITTER PICKUP AHEAD, ROAD WORK AHEAD AND WORKER AHEAD SIGNS ARE USED AS DIRECTED FOR OTHER MAINTENANCE OPERATIONS WHEN ALL WORK OCCURS OFF OF THE PAVED HIGHWAY SURFACE.

### ROLL-UP SIGNS CONFORMING TO DMS-8310 AND THE CWZTCD ALLOWED

\*Letter dimensions and spacing for "CW21-SPECIAL" is the same as C20-1D

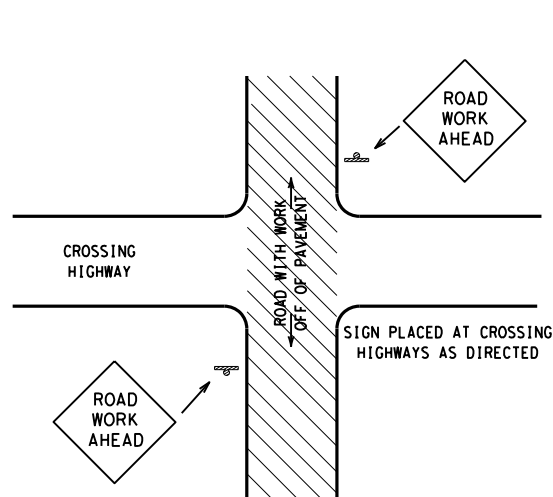

TYPICAL LOCATION OF SIGNS AT HIGHWAY CROSSING

WORK AREA IS A MAXIMUM OF 2.0 MILES UNLESS OTHERWISE DIRECTED. SIGNS MAY REMAIN IN PLACE ONLY DURING DAYLIGHT HOURS.

SIGNS ARE TO BE PLACED 6' TO 12' OFF OF THE PAVED SURFACE UNLESS OTHERWISE DIRECTED.

ROAD WORK AHEAD SIGNS SHOWN AS EXAMPLES, ONE OF THE FOUR TYPE SIGNS WILL BE USED AS DIRECTED.

\* SIGNS IN THE MEDIAN ARE REQUIRED WHEN WORK OCCURS IN MEDIAN

### UNDIVIDED HIGHWAY OR FRONTAGE ROAD

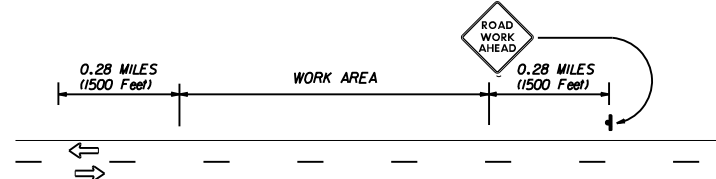

### DIVIDED HIGHWAY

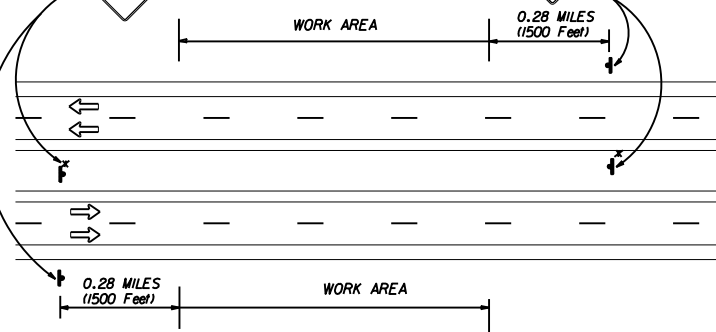

### TRAFFIC CONTROL PLAN FOR WORK OFF OF THE PAVED SURFACE.

### GENERAL NOTES FOR WORK ZONE SIGNS

- Contractor shall install and maintain signs in a straight and plumb condition and/or as directed by the Engineer.
- Wooden sign posts shall be painted white.
- Barricades shall NOT be used as sign supports.
- Nails shall NOT be used to attach signs to any support.
- All signs shall be installed in accordance with the plans or as directed by the Engineer. Signs shall be used to regulate, warn, and guide the traveling public safely through the work zone.
- The Contractor may furnish either the sign design shown in the plans or in the "Standard Highway Sign Designs for Texas" (SHSD). The Engineer/Inspector may require the Contractor to furnish other work zone signs that are shown in the TMUTCD but may have been omitted from the plans. Any variation in the plans shall be documented by written agreement between the Engineer and the Contractor's Responsible Person. All changes must be documented in writing before being implemented. This can include documenting the changes in the Inspector's TxDOT diary and having both the Inspector and Contractor initial and date the agreed upon changes. The additional signs requested by the Engineer/Inspector shall not be subsidiary.
- The Contractor shall furnish sign supports listed in the "Compliant Work Zone Traffic Control Device List" (CWZTCD). The Contractor shall install the sign support in accordance with the manufacturer's recommendations. If there is a question regarding installation procedures, the Contractor shall furnish the Engineer a copy of the manufacturer's installation recommendations so that the Engineer can verify the correct procedures are being followed.
- The Contractor is responsible for sign installations and replacing signs with damaged or cracked substrates and/or damaged or marred reflective sheeting as directed by the Engineer/Inspector.
- Identification markings may be shown only on the back of the sign substrate. The maximum height of letters and/or company logos used for identification shall be 1".
- The Contractor shall replace damaged wood posts. New or damaged wood sign posts shall not be spliced.

### Duration of Work (as defined by the "Texas Manual on Uniform Traffic Control Devices" Part VII)

- The Contractor is responsible for ensuring the sign support and substrate meets crashworthiness. For mowing operation all signs and supports are Short-term Duration for daytime work.
- The Contractor shall furnish the sign sizes shown on this sheet or as directed by the Engineer.

### SIGN SUBSTRATES

- The Contractor shall ensure that the sign substrate is allowed for the type of sign support that is being used. The CWZTCD lists each substrate that can be used on the different types and models of sign supports.
- "Mesh" type materials are NOT an approved sign substrate.
- All wooden individual sign panels fabricated from 2 or more pieces shall have one or more plywood cleat, 1/2" thick by 6" wide, fastened to the back of the sign and extending fully across the sign. The cleat shall be attached to the back of the sign using wood screws that do not penetrate the face of the sign panel. The screws shall be placed on both sides of the splice and spaced at 6" centers. The Engineer may approve other methods of splicing the sign faces.

### REFLECTIVE SHEETING

- Reflectorized signs shall be constructed of sheeting meeting the color and retro-reflectivity requirements of DMS-8300 or DMS-8310. The DMS specifications can be accessed from the following web address:  
[http://manuals.dot.state.tx.us:80/dynaweb/colmates/@Generic\\_CollectionView;cs=default;ts=default](http://manuals.dot.state.tx.us:80/dynaweb/colmates/@Generic_CollectionView;cs=default;ts=default)
- White sheeting, meeting the requirements of DMS-8300 Type C (High Specific Intensity), shall be used for signs with white background and channelizing devices.
- Orange sheeting, meeting the requirements of DMS-8300 Type E (Fluorescent Prismatic), shall be used for signs with orange backgrounds.

### SIGN LETTERS

- All sign letters and numbers shall be clear, and open rounded type uppercase alphabet letters as approved by the Federal Highway Administration (FHWA) and as published in the "Standard Highway Sign Design for Texas" manual. Signs, letters and numbers shall be of first class workmanship in accordance with Department Standards and Specifications.

### REMOVING OR COVERING

- Signs should be removed or completely covered when not mowing.
- Duct tape or other adhesive material shall NOT be affixed to a sign face.
- Signs and supports shall be removed by the end of the day.

### SIGN SUPPORT WEIGHTS

- Where sign supports require the use of weights to keep from turning over, the use of sandbags with dry cohesionless sand is recommended.
- The sandbags will be tied shut to keep the sand from spilling and to maintain a constant weight.
- Rock, concrete, iron, steel or other solid objects will not be permitted for use as sign support weights.
- Sandbags should weigh a minimum of 35 lbs and a maximum of 50 lbs.
- Sandbags shall be made of a durable material that tears upon vehicular impact.
- Rubber (such as tire inner tubes) shall NOT be used for sandbags.
- Rubber ballasts (such as those used with cones or edgeline channelizers) shall NOT be used as sign support weights.
- Sandbags shall only be placed along or laid over the base supports of the traffic control device and shall not be suspended above ground level or hung with rope, wire, chains or other fasteners. Sandbags shall be placed along the length of the skids to weigh down the sign supports.
- Sandbags shall NOT be placed under the skid and shall not be used to level sign supports placed on slopes.

### CONTRACTOR REQUIREMENTS FOR MAINTAINING PERMANENT SIGNS WITHIN THE PROJECT LIMITS

Any sign, sign support or traffic control device that is struck or damaged by the Contractor or his/her construction equipment shall be replaced or repaired as soon as possible by the Contractor at the Contractor's expense.

Only pre-qualified products shall be used. A copy of the "Compliant Work Zone Traffic Control Devices List" (CWZTCD) describes pre-qualified products and their sources and may be obtained by contacting:

Standards Engineer  
Traffic Operations Division - TE  
Texas Department of Transportation  
125 East 11th Street  
Austin, Texas 78701-2483  
Phone (512) 416-3120  
Fax (512) 416-3299

Instructions to locate the "CWZTCD" on TxDOT website are:

Start at website - [www.dot.state.tx.us](http://www.dot.state.tx.us)  
Click on "About TxDOT",  
Click on "Organizational Chart",  
Click on "Traffic Operations Box",  
Click on "Compliant Work Zone Traffic Control Devices",  
Click on "View PDF".  
This site is printable.

Texas Department of Transportation  
Maintenance Division  
Standard Plans

## ROADSIDE TRAFFIC CONTROL PLAN

SHEET 1 OF 1 RS-TCP-05 NOT TO SCALE

FILE: RSTCPO5.DGN	DN: LJB	CR: JG	DR: -	CR: -	NEG NO.:
© TxDOT FEBRUARY 2005		STATE DISTRICT	FEDERAL REGION	FEDERAL AID PROJECT	SHEET
REVISED: September 17, 2004	18	N/A	RMC-639346001	8	
REVISED: FEBRUARY 2, 2005 Sign placement in TCP		COUNTY	CONTROL SECTION	JOB	HIGHWAY
REVISED:		DALLAS	6393 46	001	IHO030

DISCLAIMER: The use of this standard is governed by the "Texas Engineering Practice Act". No warranty of any kind is made by TxDOT or any person who is involved in the design, construction, or maintenance of any project for which this standard is used.

DATE: 10/14/2021 11:02:39 AM  
 FILE: T:\DALAO\DALNEAO\Maint. Contracts\2022 RMC Folder\Tree Trimming and Brush Removal\Standard\bc-21.dgn

**BARRICADE AND CONSTRUCTION (BC) STANDARD SHEETS GENERAL NOTES:**

- The Barricade and Construction Standard Sheets (BC sheets) are intended to show typical examples for placement of temporary traffic control devices, construction pavement markings, and typical work zone signs. The information contained in these sheets meet or exceed the requirements shown in the "Texas Manual on Uniform Traffic Control Devices" (TMUTCD).
- The development and design of the Traffic Control Plan (TCP) is the responsibility of the Engineer.
- The Contractor may propose changes to the TCP that are signed and sealed by a licensed professional engineer for approval. The Engineer may develop, sign and seal Contractor proposed changes.
- The Contractor is responsible for installing and maintaining the traffic control devices as shown in the plans. The Contractor may not move or change the approximate location of any device without the approval of the Engineer.
- Geometric design of lane shifts and detours should, when possible, meet the applicable design criteria contained in manuals such as the American Association of State Highway and Transportation Officials (AASHTO), "A Policy on Geometric Design of Highways and Streets," the TxDOT "Roadway Design Manual" or engineering judgment.
- When projects abut, the Engineer(s) may omit the END ROAD WORK, TRAFFIC FINES DOUBLE, and other advance warning signs if the signing would be redundant and the work areas appear continuous to the motorists. If the adjacent project is completed first, the Contractor shall erect the necessary warning signs as shown on these sheets, the TCP sheets or as directed by the Engineer. The BEGIN ROAD WORK NEXT X MILES sign shall be revised to show appropriate work zone distance.
- The Engineer may require duplicate warning signs on the median side of divided highways where median width will permit and traffic volumes justify the signing.
- All signs shall be constructed in accordance with the details found in the "Standard Highway Sign Designs for Texas," latest edition. Sign details not shown in this manual shall be shown in the plans or the Engineer shall provide a detail to the Contractor before the sign is manufactured.
- The temporary traffic control devices shown in the illustrations of the BC sheets are examples. As necessary, the Engineer will determine the most appropriate traffic control devices to be used.
- Where highway construction or maintenance work is being undertaken, other than mobile operations as defined by the Texas Manual on Uniform Traffic Control Devices, CSJ limit signs are required. CSJ limit signs are shown on BC(2). The OBEY WARNING SIGNS STATE LAW sign, STAY ALERT TALK OR TEXT LATER and the WORK ZONE TRAFFIC FINES DOUBLE sign with plaque shall be erected in advance of the CSJ limits. The BEGIN ROAD WORK NEXT X MILES, CONTRACTOR and END ROAD WORK signs shall be erected at or near the CSJ limits. For mobile operations, CSJ limit signs are not required.
- Traffic control devices should be in place only while work is actually in progress or a definite need exists.
- The Engineer has the final decision on the location of all traffic control devices.
- Inactive equipment and work vehicles, including workers' private vehicles must be parked away from travel lanes. They should be as close to the right-of-way line as possible, or located behind a barrier or guardrail, or as approved by the Engineer.

**WORKER SAFETY NOTES:**

- Workers on foot who are exposed to traffic or to construction equipment within the right-of-way shall wear high-visibility safety apparel meeting the requirements of ISEA "American National Standard for High-Visibility Apparel," or equivalent revisions, and labeled as ANSI 107-2004 standard performance for Class 2 or 3 risk exposure. Class 3 garments should be considered for high traffic volume work areas or night time work.
- Except in emergency situations, flagger stations shall be illuminated when flagging is used at night.

**COMPLIANT WORKZONE TRAFFIC CONTROL DEVICES**

- Only pre-qualified products shall be used. The "Compliant Work Zone Traffic Control Devices List" (CWZTCD) describes pre-qualified products and their sources.
- Work zone traffic control devices shall be compliant with the Manual for Assessing safety Hardware (MASH).

<b>THE DOCUMENTS BELOW CAN BE FOUND ON-LINE AT</b> <a href="http://www.txdot.gov">http://www.txdot.gov</a>
COMPLIANT WORK ZONE TRAFFIC CONTROL DEVICES LIST (CWZTCD)
DEPARTMENTAL MATERIAL SPECIFICATIONS (DMS)
MATERIAL PRODUCER LIST (MPL)
ROADWAY DESIGN MANUAL - SEE "MANUALS (ONLINE MANUALS)"
STANDARD HIGHWAY SIGN DESIGNS FOR TEXAS (SHSD)
TEXAS MANUAL ON UNIFORM TRAFFIC CONTROL DEVICES (TMUTCD)
TRAFFIC ENGINEERING STANDARD SHEETS

SHEET 1 OF 12

 Texas Department of Transportation		Traffic Safety Division Standard	
<b>BARRICADE AND CONSTRUCTION GENERAL NOTES AND REQUIREMENTS</b>			
<b>BC (1) - 21</b>			
FILE:	bc-21.dgn	DN:	TxDOT
© TxDOT	November 2002	CK:	TxDOT
		DW:	TxDOT
		CK:	TxDOT
REVISIONS	CONT	SECT	JOB
4-03 7-13	6393	46	001
9-07 8-14			
5-10 5-21			
	DIST	COUNTY	SHEET NO.
	18	DALLAS	9

DATE: 10/14/2021 11:02:41 AM  
 FILE: T:\DALAO\DALNEAO\Maint. Contracts\2022 RMC Folder\Tree Trimming and Brush Removal\8393-216-001.dwg  
 The use of this standard is governed by the "Texas Engineering Practice Act". No warranty of any kind is made by TxDOT for any purpose whatsoever. TxDOT assumes no responsibility for the conversion of this standard to any other format.

**TYPICAL LOCATION OF CROSSROAD SIGNS**

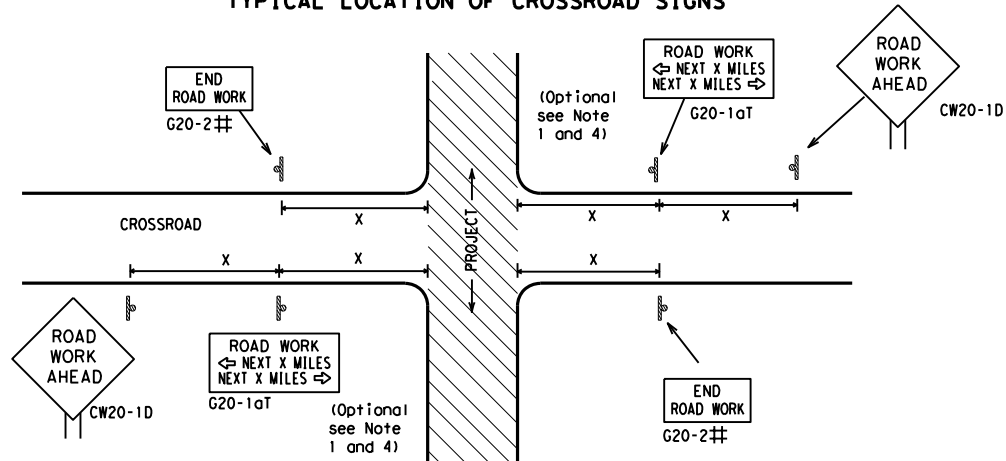

## May be mounted on back of "ROAD WORK AHEAD" (CW20-1D) sign with approval of Engineer. (See note 2 below)

1. The typical minimum signing on a crossroad approach should be a "ROAD WORK AHEAD" (CW20-1D) sign and a (G20-2) "END ROAD WORK" sign, unless noted otherwise in plans.
2. The Engineer may use the reduced size 36" x 36" ROAD WORK AHEAD (CW20-1D) sign mounted back to back with the reduced size 36" x 18" "END ROAD WORK" (G20-2) sign on low volume crossroads (see Note 4 under "Typical Construction Warning Sign Size and Spacing"). See the "Standard Highway Sign Designs for Texas" manual for sign details. The Engineer may omit the advance warning signs on low volume crossroads. The Engineer will determine whether a road is low volume as per TMUTCD Part 5. This information shall be shown in the plans.
3. Based on existing field conditions, the Engineer/Inspector may require additional signs such as FLAGGER AHEAD, LOOSE GRAVEL, or other appropriate signs. When additional signs are required, these signs will be considered part of the minimum requirements. The Engineer/Inspector will determine the proper location and spacing of any sign not shown on the BC sheets, Traffic Control Plan sheets or the Work Zone Standard Sheets.
4. The "ROAD WORK NEXT X MILES" (G20-1aT) sign shall be required at high volume crossroads to advise motorists of the length of construction in either direction from the intersection. The Engineer will determine whether a roadway is considered high volume.
5. Additional traffic control devices may be shown elsewhere in the plans for higher volume crossroads.
6. When work occurs in the intersection area, appropriate traffic control devices, as shown elsewhere in the plans or as determined by the Engineer/Inspector, shall be in place.

**T-INTERSECTION**

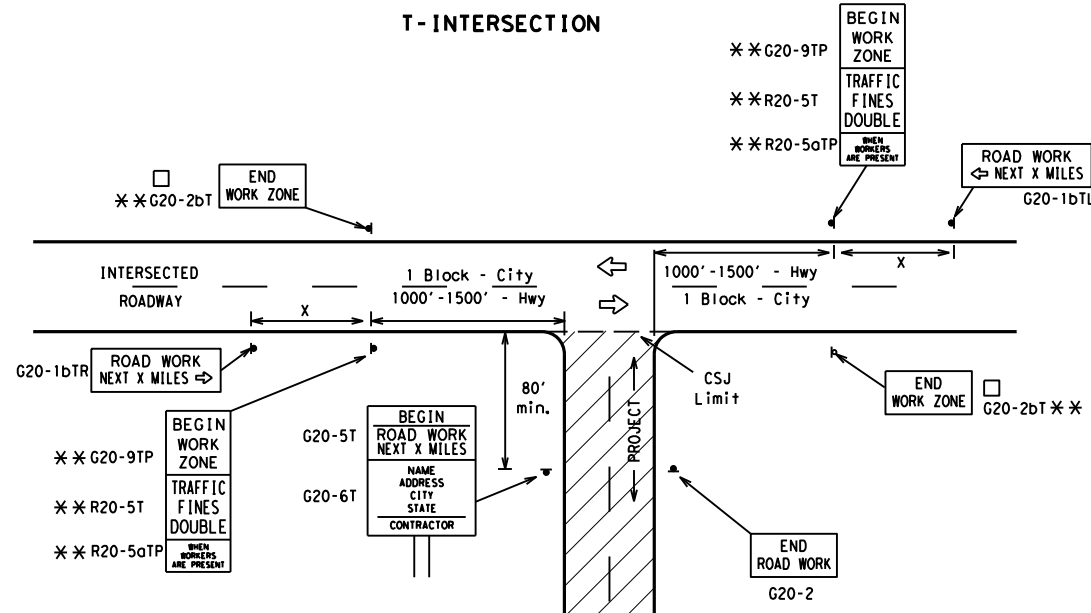

**CSJ LIMITS AT T-INTERSECTION**

1. The Engineer will determine the types and location of any additional traffic control devices, such as a flagger and accompanying signs, or other signs, that should be used when work is being performed at or near an intersection.
2. If construction closes the road at a T-intersection, the Contractor shall place the "CONTRACTOR NAME" (G20-6T) sign behind the Type 3 Barricades for the road closure (see BC(10) also). The "ROAD WORK NEXT X MILES" left arrow (G20-1bTL) and "ROAD WORK NEXT X MILES" right arrow (G20-1bTR) signs shall be replaced by the detour signing called for in the plans.

**TYPICAL CONSTRUCTION WARNING SIGN SIZE AND SPACING<sup>1,5,6</sup>**

Sign Number or Series	SIZE		SPACING	
	Conventional Road	Expressway/Freeway	Posted Speed MPH	Sign Δ Spacing "x" Feet (Apprx.)
CW20 <sup>4</sup>	48" x 48"	48" x 48"	30	120
CW21			35	160
CW22			40	240
CW23			45	320
CW25			50	400
CW1, CW2, CW7, CW8, CW9, CW11, CW14	36" x 36"	48" x 48"	55	500 <sup>2</sup>
CW3, CW4, CW5, CW6, CW8-3, CW10, CW12	48" x 48"	48" x 48"	60	600 <sup>2</sup>
			65	700 <sup>2</sup>
			70	800 <sup>2</sup>
			75	900 <sup>2</sup>
			80	1000 <sup>2</sup>
*			*	* <sup>3</sup>

\* For typical sign spacings on divided highways, expressways and freeways, see Part 6 of the "Texas Manual on Uniform Traffic Control Devices" (TMUTCD) typical application diagrams or TCP Standard Sheets.

Δ Minimum distance from work area to first Advance Warning sign nearest the work area and/or distance between each additional sign.

**GENERAL NOTES**

1. Special or larger size signs may be used as necessary.
2. Distance between signs should be increased as required to have 1500 feet advance warning.
3. Distance between signs should be increased as required to have 1/2 mile or more advance warning.
4. 36" x 36" "ROAD WORK AHEAD" (CW20-1D) signs may be used on low volume crossroads at the discretion of the Engineer as per TMUTCD Part 5. See Note 2 under "Typical Location of Crossroad Signs".
5. Only diamond shaped warning sign sizes are indicated.
6. See sign size listing in "TMUTCD", Sign Appendix or the "Standard Highway Sign Designs for Texas" manual for complete list of available sign design sizes.

**WORK AREAS IN MULTIPLE LOCATIONS WITHIN CSJ LIMITS**

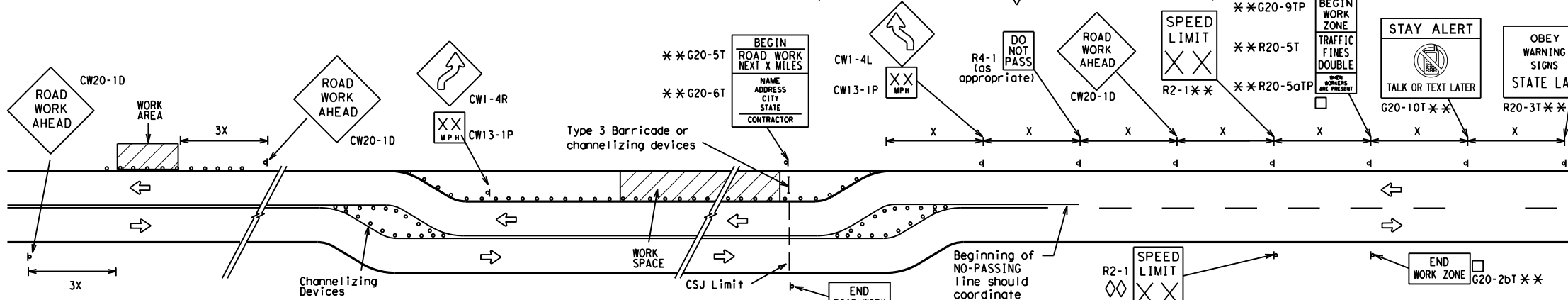

When extended distances occur between minimal work spaces, the Engineer/Inspector should ensure additional "ROAD WORK AHEAD" (CW20-1D) signs are placed in advance of these work areas to remind drivers they are still within the project limits. See the applicable TCP sheets for exact location and spacing of signs and channelizing devices.

**SAMPLE LAYOUT OF SIGNING FOR WORK BEGINNING DOWNSTREAM OF THE CSJ LIMITS**

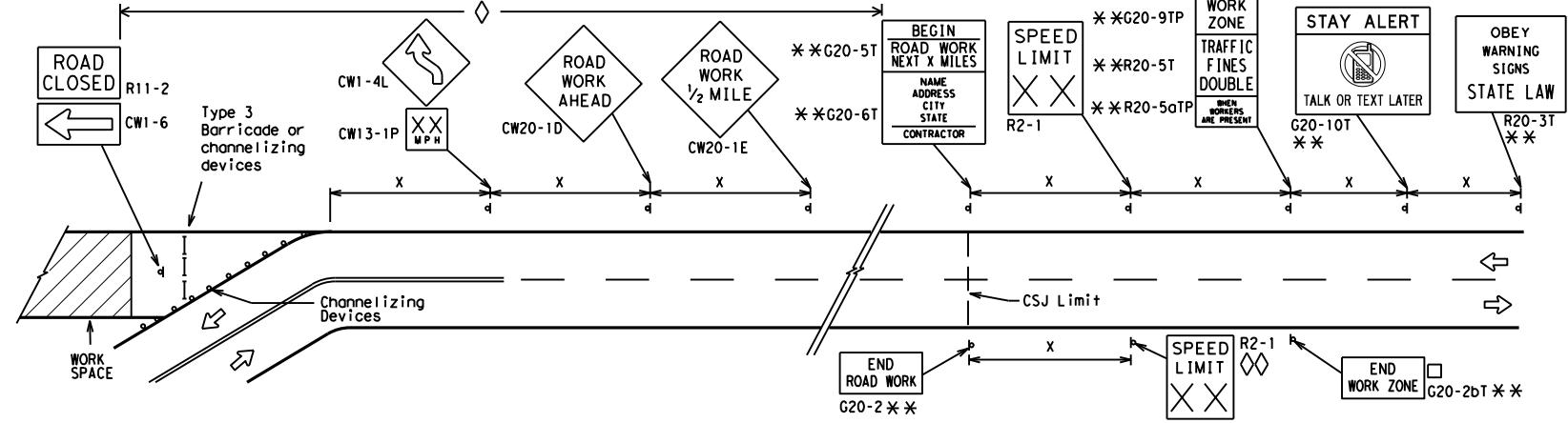

**NOTES**

- The Contractor shall determine the appropriate distance to be placed on the G20-1 series signs and "BEGIN ROAD WORK NEXT X MILES" (G20-5T) sign for each specific project. This distance shall replace the "x" and shall be rounded to the nearest whole mile with the approval of the Engineer. No decimals shall be used.
- The "BEGIN WORK ZONE" (G20-9TP) and "END WORK ZONE" (G20-2bT) shall be used as shown on the sample layout when advance signs are required outside the CSJ Limits. They inform the motorist of entering or leaving a part of the work zone lying outside the CSJ Limits where traffic fines may double if workers are present.
- CSJ limit signing is required for highway construction and maintenance work, with the exception of mobile operations.
- Area for placement of "ROAD WORK AHEAD" (CW20-1D) sign and other signs or devices as called for on the Traffic Control Plan.
- Contractor will install a regulatory speed limit sign at the end of the work zone.

**LEGEND**

—	Type 3 Barricade
○ ○ ○	Channelizing Devices
■	Sign
X	See Typical Construction Warning Sign Size and Spacing chart or the TMUTCD for sign spacing requirements.

SHEET 2 OF 12



**BARRICADE AND CONSTRUCTION PROJECT LIMIT**

**BC(2)-21**

FILE: bc-21.dgn	DN: TxDOT	CK: TxDOT	DW: TxDOT	CK: TxDOT
© TxDOT November 2002	CONT	SECT	JOB	HIGHWAY
REVISIONS	6393	46	001	IHO030
9-07 8-14	DIST	COUNTY	SHEET NO.	
7-13 5-21	18	DALLAS	10	

# TYPICAL APPLICATION OF WORK ZONE SPEED LIMIT SIGNS

Work zone speed limits shall be regulatory, established in accordance with the "Procedures for Establishing Speed Zones," and approved by the Texas Transportation Commission, or by City Ordinance when within Incorporated City Limits.

Reduced speeds should only be posted in the vicinity of work activity and not throughout the entire project. Regulatory work zone speed signs (R2-1) shall be removed or covered during periods when they are not needed.

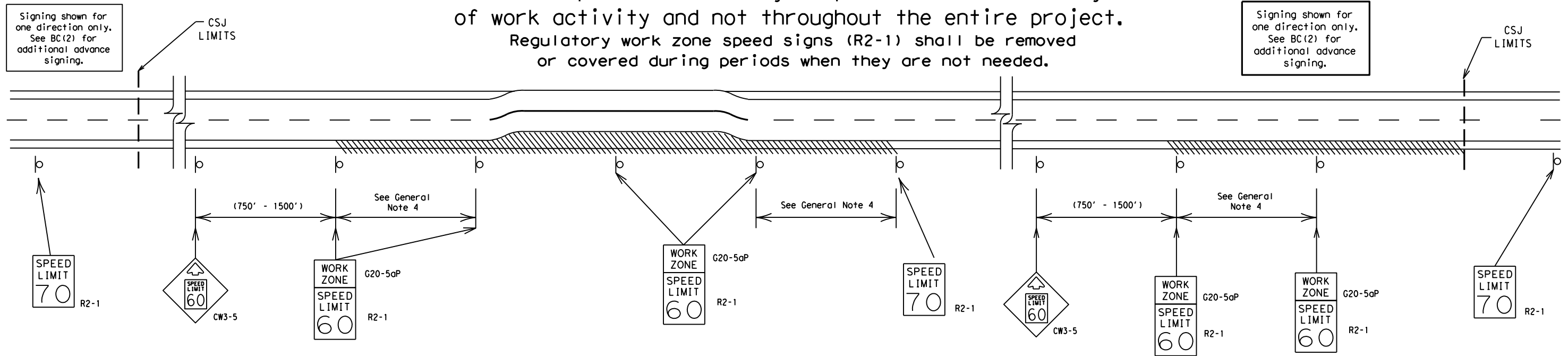

## GUIDANCE FOR USE:

### LONG/INTERMEDIATE TERM WORK ZONE SPEED LIMITS

This type of work zone speed limit should be included on the design of the traffic control plans when restricted geometrics with a lower design speed are present in the work zone and modification of the geometrics to a higher design speed is not feasible.

Long/Intermediate Term Work Zone Speed Limit signs, when approved as described above, should be posted and visible to the motorist when work activity is present. Work activity may also be defined as a change in the roadway that requires a reduced speed for motorists to safely negotiate the work area, including:

- rough road or damaged pavement surface
- substantial alteration of roadway geometrics (diversions)
- construction detours
- grade
- width
- other conditions readily apparent to the driver

As long as any of these conditions exist, the work zone speed limit signs should remain in place.

### SHORT TERM WORK ZONE SPEED LIMITS

This type of work zone speed limit may be included on the design of the traffic control plans when workers or equipment are not behind concrete barrier, when work activity is within 10 feet of the traveled way or actually in the traveled way.

Short Term Work Zone Speed Limit signs should be posted and visible to the motorists only when work activity is present. When work activity is not present, signs shall be removed or covered. (See Removing or Covering on BC(4)).

## GENERAL NOTES

- Regulatory work zone speed limits should be used only for sections of construction projects where speed control is of major importance.
- Regulatory work zone speed limit signs shall be placed on supports at a 7 foot minimum mounting height.
- Speed zone signs are illustrated for one direction of travel and are normally posted for each direction of travel.
- Frequency of work zone speed limit signs should be:
 

40 mph and greater	0.2 to 2 miles
35 mph and less	0.2 to 1 mile
- Regulatory speed limit signs shall have black legend and border on a white reflective background (See "Reflective Sheeting" on BC(4)).
- Fabrication, erection and maintenance of the "ADVANCE SPEED LIMIT" (CW3-5) sign, "WORK ZONE" (G20-5aP) plaque and the "SPEED LIMIT" (R2-1) signs shall not be paid for directly, but shall be considered subsidiary to Item 502.
- Turning signs from view, laying signs over or down will not be allowed, unless as otherwise noted under "REMOVING OR COVERING" on BC(4).
- Techniques that may help reduce traffic speeds include but are not limited to:
  - Law enforcement.
  - Flagger stationed next to sign.
  - Portable changeable message sign (PCMS).
  - Low-power (drone) radar transmitter.
  - Speed monitor trailers or signs.
- Speeds shown on details above are for illustration only. Work Zone Speed Limits should only be posted as approved for each project.
- For more specific guidance concerning the type of work, work zone conditions and factors impacting allowable regulatory construction speed zone reduction see TxDOT form #1204 in the TxDOT e-form system.

DISCLAIMER: The use of this standard is governed by the "Texas Engineering Practice Act". No warranty of any kind is made by TxDOT for any purpose whatsoever. TxDOT assumes no responsibility for the conversion or use of this standard. The use of this standard is governed by the "Texas Engineering Practice Act". No warranty of any kind is made by TxDOT for any purpose whatsoever. TxDOT assumes no responsibility for the conversion or use of this standard.

SHEET 3 OF 12

<h2>BARRICADE AND CONSTRUCTION WORK ZONE SPEED LIMIT</h2>			
<h3>BC (3) - 21</h3>			
FILE:	bc-21.dgn	DW:	TxDOT
© TxDOT	November 2002	CONT:	6393 46
REVISIONS:		SECT:	001
9-07	8-14	JOB:	IHO030
7-13	5-21	DIST:	18
		COUNTY:	DALLAS
		SHEET NO.:	11

DISCLAIMER: The use of this standard is governed by the "Texas Engineering Practice Act". No warranty of any kind is made by TxDOT for any purpose whatsoever. TxDOT assumes no responsibility for the conversion of this standard to other formats or for incorrect results or damages resulting from its use.

DATE: 10/14/2021 11:02:46 AM  
 FILE: T:\DALAO\DALNEAO\Maint. Contracts\2022 RMC Folder\Tree Trimming and Brush Removal\Standards\bc-21.dgn

**TYPICAL MINIMUM CLEARANCES FOR LONG TERM AND INTERMEDIATE TERM SIGNS**

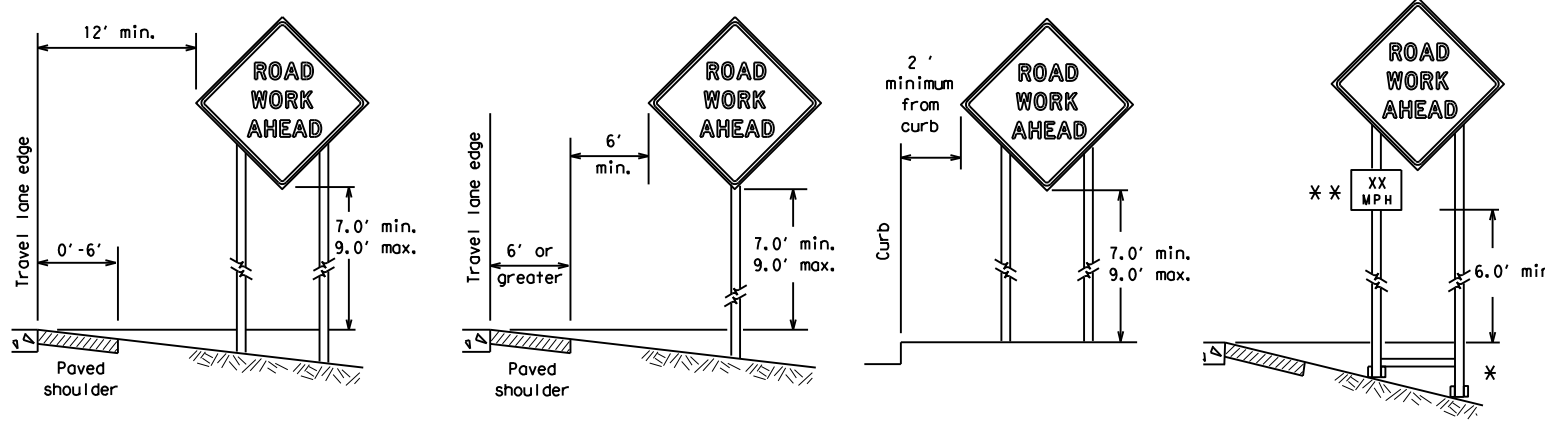

\* When placing skid supports on unlevel ground, the leg post lengths must be adjusted so the sign appears straight and plumb. Objects shall NOT be placed under skids as a means of leveling.

\*\* When plaques are placed on dual-leg supports, they should be attached to the upright nearest the travel lane. Supplemental plaques (advisory or distance) should not cover the surface of the parent sign.

**ATTACHMENT FOR SIGN SUPPORTS**

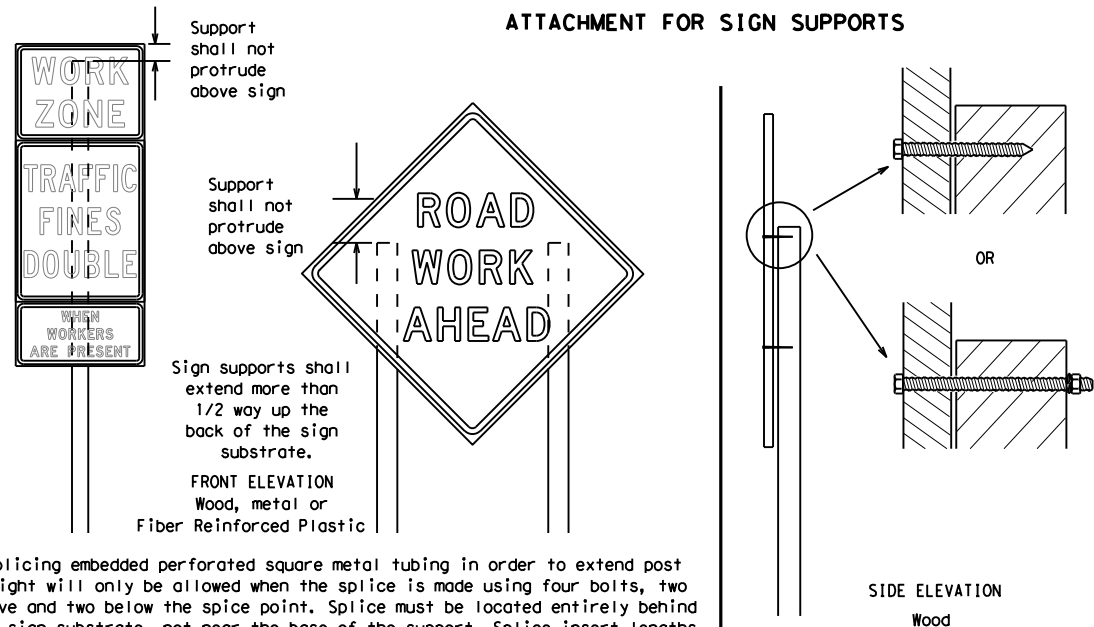

**Nails shall NOT be allowed.**  
 Each sign shall be attached directly to the sign support. Multiple signs shall not be joined or spliced by any means. Wood supports shall not be extended or repaired by splicing or other means.

Splicing embedded perforated square metal tubing in order to extend post height will only be allowed when the splice is made using four bolts, two above and two below the splice point. Splice must be located entirely behind the sign substrate, not near the base of the support. Splice insert lengths should be at least 5 times nominal post size, centered on the splice and of at least the same gauge material.

**STOP/SLOW PADDLES**

1. STOP/SLOW paddles are the primary method to control traffic by flaggers. The STOP/SLOW paddle size should be 24" x 24".
2. STOP/SLOW paddles shall be retroreflectORIZED when used at night.
3. STOP/SLOW paddles may be attached to a staff with a minimum length of 6' to the bottom of the sign.
4. Any lights incorporated into the STOP or SLOW paddle faces shall only be as specifically described in Section 6E.03 Hand Signaling Devices in the TMUTCD.

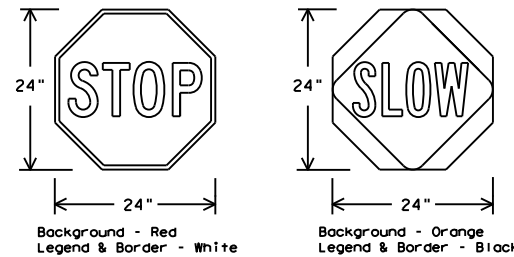

SHEETING REQUIREMENTS (WHEN USED AT NIGHT)		
USAGE	COLOR	SIGN FACE MATERIAL
BACKGROUND	RED	TYPE B OR C SHEETING
BACKGROUND	ORANGE	TYPE B <sub>FL</sub> OR C <sub>FL</sub> SHEETING
LEGEND & BORDER	WHITE	TYPE B OR C SHEETING
LEGEND & BORDER	BLACK	ACRYLIC NON-REFLECTIVE FILM

**CONTRACTOR REQUIREMENTS FOR MAINTAINING PERMANENT SIGNS WITHIN THE PROJECT LIMITS**

1. Permanent signs are used to give notice of traffic laws or regulations, call attention to conditions that are potentially hazardous to traffic operations, show route designations, destinations, directions, distances, services, points of interest, and other geographical, recreational, specific service (LOGO), or cultural information. Drivers proceeding through a work zone need the same, if not better route guidance as normally installed on a roadway without construction.
2. When permanent regulatory or warning signs conflict with work zone conditions, remove or cover the permanent signs until the permanent sign message matches the roadway condition. For details for covering large guide signs see the TS-CD standard.
3. When existing permanent signs are moved and relocated due to construction purposes, they shall be visible to motorists at all times.
4. If existing signs are to be relocated on their original supports, they shall be installed on crashworthy bases as shown on the SMD Standard sheets. The signs shall meet the required mounting heights shown on the BC Sheets or the SMD Standards. This work should be paid for under the appropriate pay item for relocating existing signs.
5. If permanent signs are to be removed and relocated using temporary supports, the Contractor shall use crashworthy supports as shown on the BC standard sheets, TLRs standard sheets or the CWZTCD list. The signs shall meet the required mounting heights shown on the BC, or the SMD standard sheets during construction. This work should be paid for under the appropriate pay item for relocating existing signs.
6. Any sign or traffic control device that is struck or damaged by the Contractor or his/her construction equipment shall be replaced as soon as possible by the Contractor to ensure proper guidance for the motorists. This will be subsidiary to Item 502.

**GENERAL NOTES FOR WORK ZONE SIGNS**

1. Contractor shall install and maintain signs in a straight and plumb condition and/or as directed by the Engineer.
2. Wooden sign posts shall be painted white.
3. Barricades shall NOT be used as sign supports.
4. All signs shall be installed in accordance with the plans or as directed by the Engineer. Signs shall be used to regulate, warn, and guide the traveling public safely through the work zone.
5. The Contractor may furnish either the sign design shown in the plans or in the "Standard Highway Sign Designs for Texas" (SHSD). The Engineer/Inspector may require the Contractor to furnish other work zone signs that are shown in the TMUTCD but may have been omitted from the plans. Any variation in the plans shall be documented by written agreement between the Engineer and the Contractor's Responsible Person. All changes must be documented in writing before being implemented. This can include documenting the changes in the Inspector's TxDOT diary and having both the Inspector and Contractor initial and date the agreed upon changes.
6. The Contractor shall furnish sign supports listed in the "Compliant Work Zone Traffic Control Device List" (CWZTCD) for small roadside signs. Supports for temporary large roadside signs shall meet the requirements detailed on the Temporary Large Roadside Signs (TLRS) standard sheets. The Contractor shall install the sign support in accordance with the manufacturer's recommendations. If there is a question regarding installation procedures, the Contractor shall furnish the Engineer a copy of the manufacturer's installation recommendations so the Engineer can verify the correct procedures are being followed.
7. The Contractor is responsible for installing signs on approved supports and replacing signs with damaged or cracked substrates and/or damaged or marred reflective sheeting as directed by the Engineer/Inspector.
8. Identification markings may be shown only on the back of the sign substrate. The maximum height of letters and/or company logos used for identification shall be 1 inch.
9. The Contractor shall replace damaged wood posts. New or damaged wood sign posts shall not be spliced.

**DURATION OF WORK (as defined by the "Texas Manual on Uniform Traffic Control Devices" Part 6)**

1. The types of sign supports, sign mounting height, the size of signs, and the type of sign substrates can vary based on the type of work being performed. The Engineer is responsible for selecting the appropriate size sign for the type of work being performed. The Contractor is responsible for ensuring the sign support, sign mounting height and substrate meets manufacturer's recommendations in regard to crashworthiness and duration of work requirements.
  - a. Long-term stationary - work that occupies a location more than 3 days.
  - b. Intermediate-term stationary - work that occupies a location more than one daylight period up to 3 days, or nighttime work lasting more than one hour.
  - c. Short-term stationary - daytime work that occupies a location for more than 1 hour in a single daylight period.
  - d. Short, duration - work that occupies a location up to 1 hour.
  - e. Mobile - work that moves continuously or intermittently (stopping for up to approximately 15 minutes.)

**SIGN MOUNTING HEIGHT**

1. The bottom of Long-term/Intermediate-term signs shall be at least 7 feet, but not more than 9 feet, above the paved surface, except as shown for supplemental plaques mounted below other signs.
2. The bottom of Short-term/Short Duration signs shall be a minimum of 1 foot above the pavement surface but no more than 2 feet above the ground.
3. Long-term/Intermediate-term Signs may be used in lieu of Short-term/Short Duration signing.
4. Short-term/Short Duration signs shall be used only during daylight and shall be removed at the end of the workday or raised to appropriate Long-term/Intermediate sign height.
5. Regulatory signs shall be mounted at least 7 feet, but not more than 9 feet, above the paved surface regardless of work duration.

**SIZE OF SIGNS**

1. The Contractor shall furnish the sign sizes shown on BC (2) unless otherwise shown in the plans or as directed by the Engineer.

**SIGN SUBSTRATES**

1. The Contractor shall ensure the sign substrate is installed in accordance with the manufacturer's recommendations for the type of sign support that is being used. The CWZTCD lists each substrate that can be used on the different types and models of sign supports.
2. "Mesh" type materials are NOT an approved sign substrate, regardless of the tightness of the weave.
3. All wooden individual sign panels fabricated from 2 or more pieces shall have one or more plywood cleat, 1/2" thick by 6" wide, fastened to the back of the sign and extending fully across the sign. The cleat shall be attached to the back of the sign using wood screws that do not penetrate the face of the sign panel. The screws shall be placed on both sides of the splice and spaced at 6" centers. The Engineer may approve other methods of splicing the sign face.

**REFLECTIVE SHEETING**

1. All signs shall be retroreflective and constructed of sheeting meeting the color and retro-reflectivity requirements of DMS-8300 for rigid signs or DMS-8310 for roll-up signs. The web address for DMS specifications is shown on BC(1).
2. White sheeting, meeting the requirements of DMS-8300 Type A, shall be used for signs with a white background.
3. Orange sheeting, meeting the requirements of DMS-8300 Type B<sub>FL</sub> or Type C<sub>FL</sub>, shall be used for rigid signs with orange backgrounds.

**SIGN LETTERS**

1. All sign letters and numbers shall be clear, and open rounded type uppercase alphabet letters as approved by the Federal Highway Administration (FHWA) and as published in the "Standard Highway Sign Design for Texas" manual. Signs, letters and numbers shall be of first class workmanship in accordance with Department Standards and Specifications.

**REMOVING OR COVERING**

1. When sign messages may be confusing or do not apply, the signs shall be removed or completely covered.
2. Long-term stationary or intermediate stationary signs installed on square metal tubing may be turned away from traffic 90 degrees when the sign message is not applicable. This technique may not be used for signs installed in the median of divided highways or near any intersections where the sign may be seen from approaching traffic.
3. Signs installed on wooden skids shall not be turned at 90 degree angles to the roadway. These signs should be removed or completely covered when not required.
4. When signs are covered, the material used shall be opaque, such as heavy mil black plastic, or other materials which will cover the entire sign face and maintain their opaque properties under automobile headlights at night, without damaging the sign sheeting.
5. Burlap shall NOT be used to cover signs.
6. Duct tape or other adhesive material shall NOT be affixed to a sign face.
7. Signs and anchor stubs shall be removed and holes backfilled upon completion of work.

**SIGN SUPPORT WEIGHTS**

1. Where sign supports require the use of weights to keep from turning over, the use of sandbags with dry, cohesionless sand should be used.
2. The sandbags will be tied shut to keep the sand from spilling and to maintain a constant weight.
3. Rock, concrete, iron, steel or other solid objects shall not be permitted for use as sign support weights.
4. Sandbags should weigh a minimum of 35 lbs and a maximum of 50 lbs.
5. Sandbags shall be made of a durable material that tears upon vehicular impact. Rubber (such as tire inner tubes) shall NOT be used.
6. Rubber ballasts designed for channelizing devices should not be used for ballast on portable sign supports. Sign supports designed and manufactured with rubber bases may be used when shown on the CWZTCD list.
7. Sandbags shall only be placed along or laid over the base supports of the traffic control device and shall not be suspended above ground level or hung with rope, wire, chains or other fasteners. Sandbags shall be placed along the length of the skids to weigh down the sign support.
8. Sandbags shall NOT be placed under the skid and shall not be used to level sign supports placed on slopes.

**FLAGS ON SIGNS**

1. Flags may be used to draw attention to warning signs. When used, the flag shall be 16 inches square or larger and shall be orange or fluorescent red-orange in color. Flags shall not be allowed to cover any portion of the sign face.

SHEET 4 OF 12

		<b>Traffic Safety Division Standard</b>	
<b>BARRICADE AND CONSTRUCTION TEMPORARY SIGN NOTES</b>			
<b>BC (4) - 21</b>			
FILE:	bc-21.dgn	DN:	TxDOT
© TxDOT	November 2002	CR:	TxDOT
REVISIONS	CONT	SECT	JOB
9-07 8-14	6393	46	001
7-13 5-21	DIST	COUNTY	SHEET NO.
	18	DALLAS	12



DATE: 10/14/2021 11:02:48 AM  
 FILE: T:\DALAO\DALNEAO\Maint. Contracts\2022 RMC Folder\Tree Trimming and Brush Removal\6393-46-001\_East Tree Trimming & Brush Removal Standards\bc-21.dgn  
 DISCLAIMER: The use of this standard is governed by the "Texas Engineering Practice Act". No warranty of any kind is made by TxDOT for any purpose whatsoever. TxDOT assumes no responsibility for the conversion of this standard to other formats for incorrect results resulting from its use.

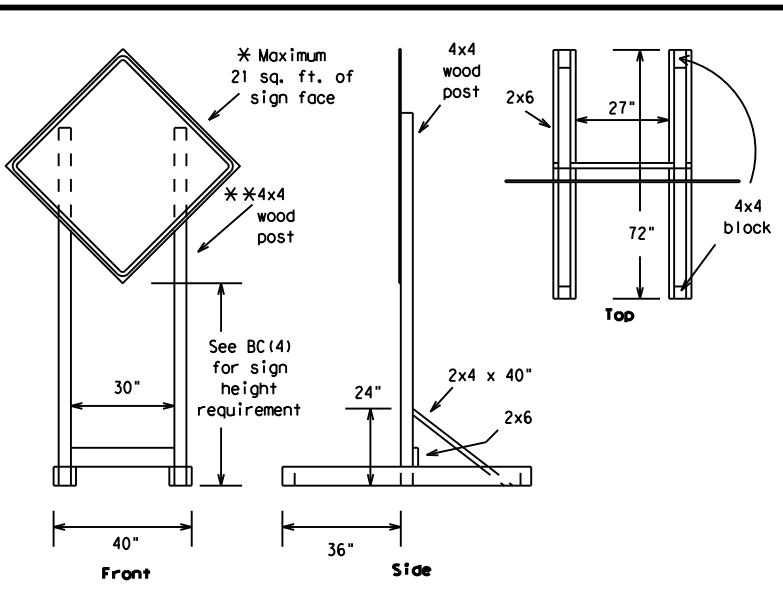

### SKID MOUNTED WOOD SIGN SUPPORTS

\* LONG/INTERMEDIATE TERM STATIONARY - PORTABLE SKID MOUNTED SIGN SUPPORTS

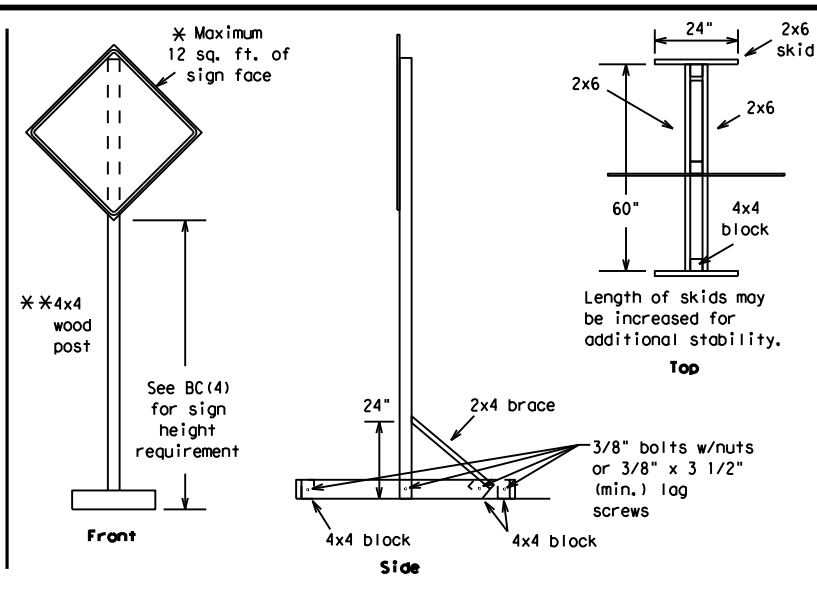

### SKID MOUNTED PERFORATED SQUARE STEEL TUBING SIGN SUPPORTS

\* LONG/INTERMEDIATE TERM STATIONARY - PORTABLE SKID MOUNTED SIGN SUPPORTS

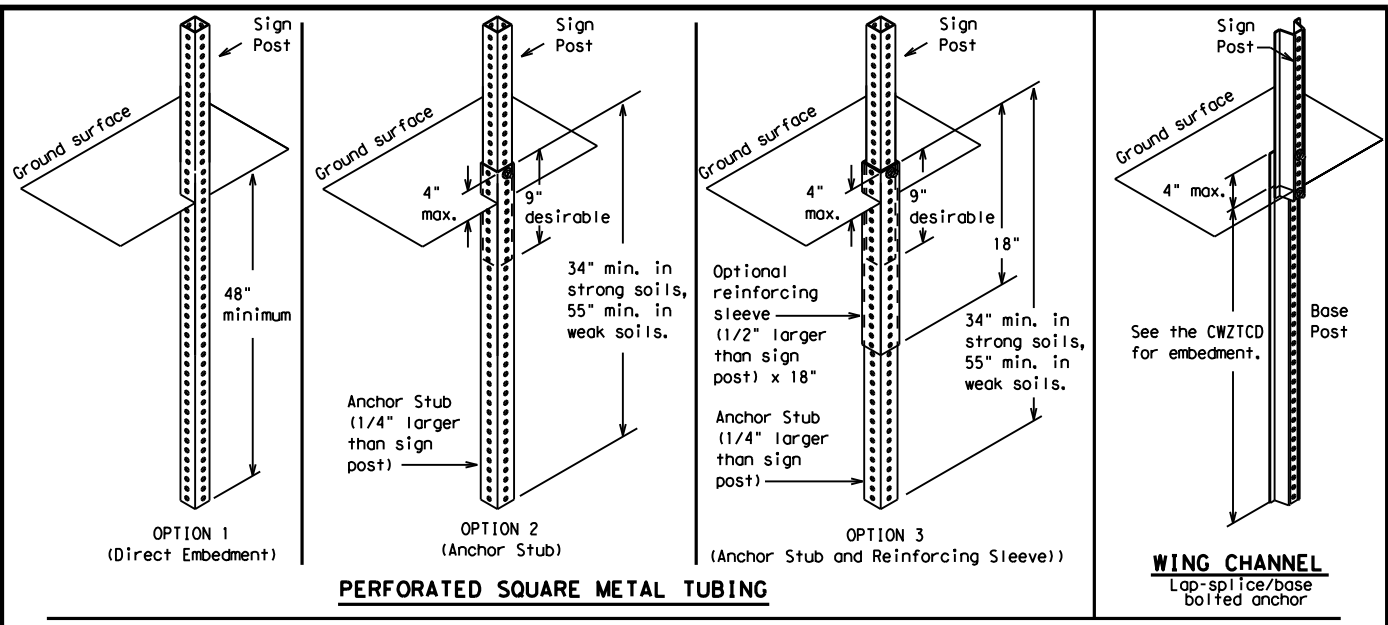

### GROUND MOUNTED SIGN SUPPORTS

Refer to the CWZTCD and the manufacturer's installation procedure for each type sign support.  
 The maximum sign square footage shall adhere to the manufacturer's recommendation.  
 Two post installations can be used for larger signs.

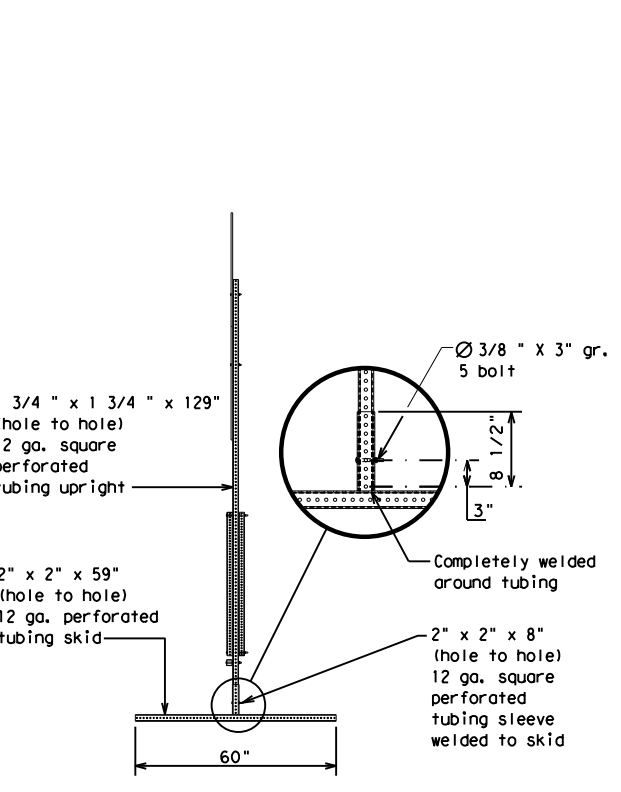
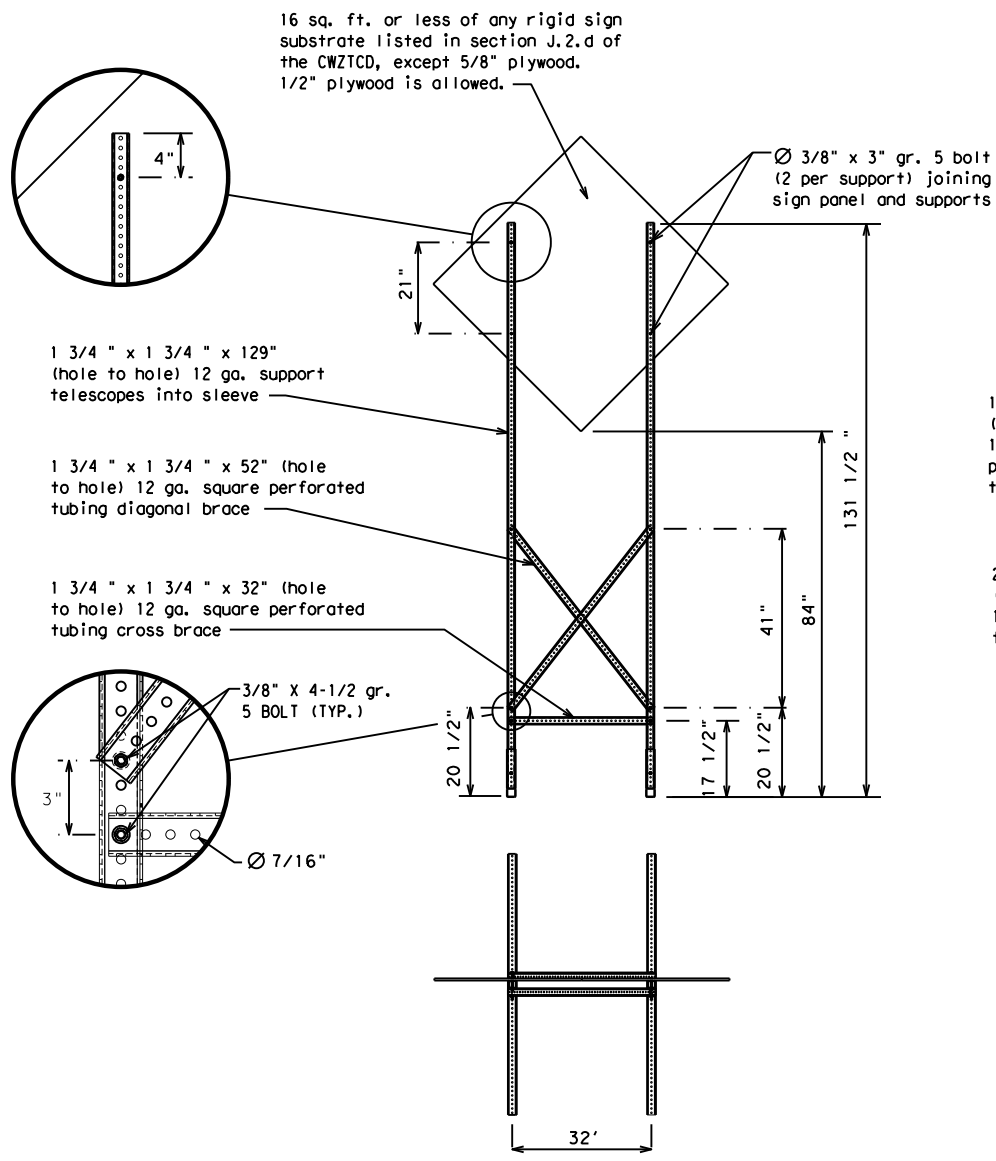
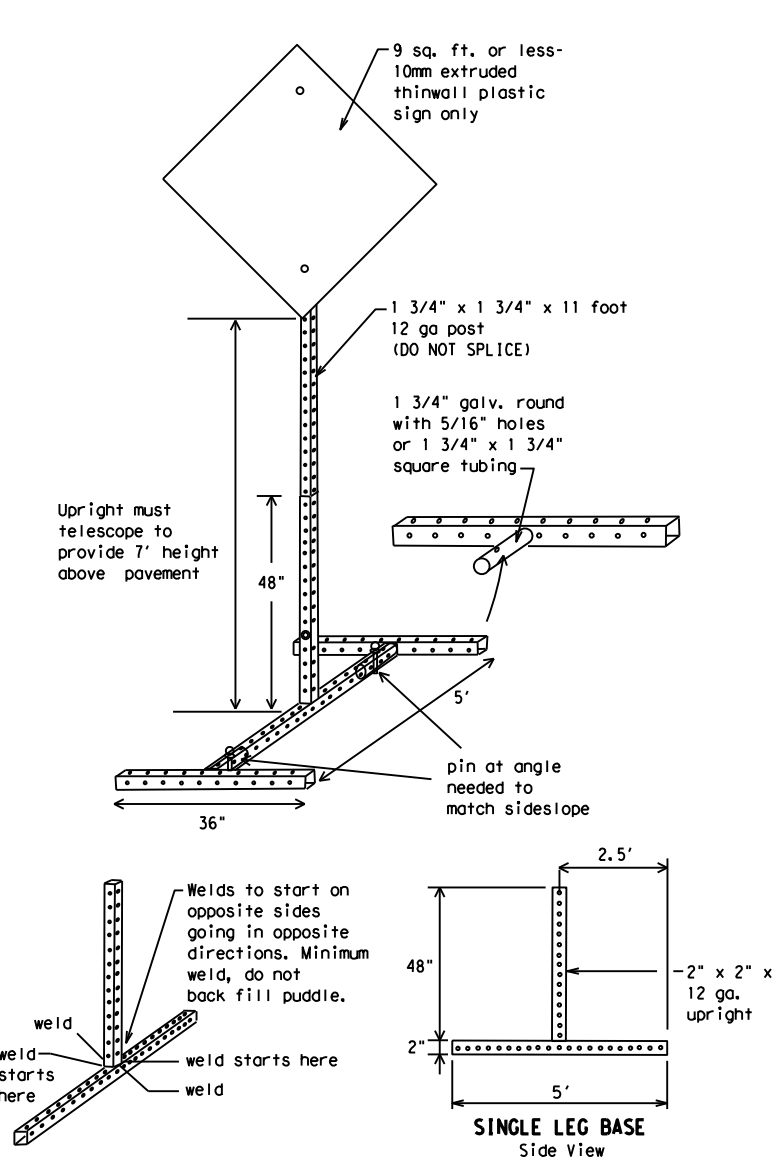

### WEDGE ANCHORS

Both steel and plastic Wedge Anchor Systems as shown on the SMD Standard Sheets may be used as temporary sign supports for signs up to 10 square feet of sign face. They may be set in concrete or in sturdy soils if approved by the Engineer. (See web address for "Traffic Engineering Standard Sheets" on BC(1)).

### OTHER DESIGNS

MORE DETAILS OF APPROVED LONG/INTERMEDIATE AND SHORT TERM SUPPORTS CAN BE FOUND ON THE CWZTCD LIST. SEE BC(1) FOR WEBSITE LOCATION.

### GENERAL NOTES

- Nails may be used in the assembly of wooden sign supports, but 3/8" bolts with nuts or 3/8" x 3 1/2" lag screws must be used on every joint for final connection.
- No more than 2 sign posts shall be placed within a 7 ft. circle, except for specific materials noted on the CWZTCD List.
- When project is completed, all sign supports and foundations shall be removed from the project site. This will be considered subsidiary to Item 502.

- \* See BC(4) for definition of "Work Duration."
- \*\* Wood sign posts MUST be one piece. Splicing will NOT be allowed. Posts shall be painted white.
- See the CWZTCD for the type of sign substrate that can be used for each approved sign support.

SHEET 5 OF 12



## BARRICADE AND CONSTRUCTION TYPICAL SIGN SUPPORT

### BC(5) - 21

FILE:	bc-21.dgn	DN:	TxDOT	CK:	TxDOT	DW:	TxDOT	CR:	TxDOT
© TxDOT	November 2002	CONT	SECT	JOB	HIGHWAY				
REVISIONS	6393	46	001	IHO030					
9-07	8-14	DIST	COUNTY	SHEET NO.					
7-13	5-21	18	DALLAS	13					

WHEN NOT IN USE, REMOVE THE PCMS FROM THE RIGHT-OF-WAY OR PLACE THE PCMS BEHIND BARRIER OR GUARDRAIL WITH SIGN PANEL TURNED PARALLEL TO TRAFFIC

# RECOMMENDED PHASES AND FORMATS FOR PCMS MESSAGES DURING ROADWORK ACTIVITIES

(The Engineer may approve other messages not specifically covered here.)

## PORTABLE CHANGEABLE MESSAGE SIGNS

- The Engineer/Inspector shall approve all messages used on portable changeable message signs (PCMS).
- Messages on PCMS should contain no more than 8 words (about four to eight characters per word), not including simple words such as "TO," "FOR," "AT," etc.
- Messages should consist of a single phase, or two phases that alternate. Three-phase messages are not allowed. Each phase of the message should convey a single thought, and must be understood by itself.
- Use the word "EXIT" to refer to an exit ramp on a freeway; i.e., "EXIT CLOSED." Do not use the term "RAMP."
- Always use the route or interstate designation (IH, US, SH, FM) along with the number when referring to a roadway.
- When in use, the bottom of a stationary PCMS message panel should be a minimum 7 feet above the roadway, where possible.
- The message term "WEEKEND" should be used only if the work is to start on Saturday morning and end by Sunday evening at midnight. Actual days and hours of work should be displayed on the PCMS if work is to begin on Friday evening and/or continue into Monday morning.
- The Engineer/Inspector may select one of two options which are available for displaying a two-phase message on a PCMS. Each phase may be displayed for either four seconds each or for three seconds each.
- Do not "flash" messages or words included in a message. The message should be steady burn or continuous while displayed.
- Do not present redundant information on a two-phase message; i.e., keeping two lines of the message the same and changing the third line.
- Do not use the word "Danger" in message.
- Do not display the message "LANES SHIFT LEFT" or "LANES SHIFT RIGHT" on a PCMS. Drivers do not understand the message.
- Do not display messages that scroll horizontally or vertically across the face of the sign.
- The following table lists abbreviated words and two-word phrases that are acceptable for use on a PCMS. Both words in a phrase must be displayed together. Words or phrases not on this list should not be abbreviated, unless shown in the TMUTCD.
- PCMS character height should be at least 18 inches for trailer mounted units. They should be visible from at least 1/2 (.5) mile and the text should be legible from at least 600 feet at night and 800 feet in daylight. Truck mounted units must have a character height of 10 inches and must be legible from at least 400 feet.
- Each line of text should be centered on the message board rather than left or right justified.
- If disabled, the PCMS should default to an illegible display that will not alarm motorists and will only be used to alert workers that the PCMS has malfunctioned. A pattern such as a series of horizontal solid bars is appropriate.

## Phase 1: Condition Lists

### Road/Lane/Ramp Closure List

FREEWAY CLOSED X MILE	FRONTAGE ROAD CLOSED
ROAD CLOSED AT SH XXX	SHOULDER CLOSED XXX FT
ROAD CLSD AT FM XXXX	RIGHT LN CLOSED XXX FT
RIGHT X LANES CLOSED	RIGHT X LANES OPEN
CENTER LANE CLOSED	DAYTIME LANE CLOSURES
NIGHT LANE CLOSURES	I-XX SOUTH EXIT CLOSED
VARIOUS LANES CLOSED	EXIT XXX CLOSED X MILE
EXIT CLOSED	RIGHT LN TO BE CLOSED
MALL DRIVEWAY CLOSED	X LANES CLOSED TUE - FRI
XXXXXXXX BLVD CLOSED	

### Other Condition List

ROADWORK XXX FT	ROAD REPAIRS XXXX FT
FLAGGER XXXX FT	LANE NARROWS XXXX FT
RIGHT LN NARROWS XXXX FT	TWO-WAY TRAFFIC XX MILE
MERGING TRAFFIC XXXX FT	CONST TRAFFIC XXX FT
LOOSE GRAVEL XXXX FT	UNEVEN LANES XXXX FT
DETOUR X MILE	ROUGH ROAD XXXX FT
ROADWORK PAST SH XXXX	ROADWORK NEXT FRI-SUN
BUMP XXXX FT	US XXX EXIT X MILES
TRAFFIC SIGNAL XXXX FT	LANES SHIFT *

\* LANES SHIFT in Phase 1 must be used with STAY IN LANE in Phase 2.

## Phase 2: Possible Component Lists

### Action to Take/Effect on Travel List

MERGE RIGHT	FORM X LINES RIGHT
DETOUR NEXT X EXITS	USE XXXXX RD EXIT
USE EXIT XXX	USE EXIT I-XX NORTH
STAY ON US XXX SOUTH	USE I-XX E TO I-XX N
TRUCKS USE US XXX N	WATCH FOR TRUCKS
WATCH FOR TRUCKS	EXPECT DELAYS
EXPECT DELAYS	PREPARE TO STOP
REDUCE SPEED XXX FT	END SHOULDER USE
USE OTHER ROUTES	WATCH FOR WORKERS
STAY IN LANE *	

### Location List

AT FM XXXX
BEFORE RAILROAD CROSSING
NEXT X MILES
PAST US XXX EXIT
XXXXXXXX TO XXXXXX
US XXX TO FM XXXX

### Warning List

SPEED LIMIT XX MPH
MAXIMUM SPEED XX MPH
MINIMUM SPEED XX MPH
ADVISORY SPEED XX MPH
RIGHT LANE EXIT
USE CAUTION
DRIVE SAFELY
DRIVE WITH CARE

### \*\* Advance Notice List

TUE-FRI XX AM-X PM
APR XX-XX X PM-X AM
BEGINS MONDAY
BEGINS MAY XX
MAY X-X XX PM-XX AM
NEXT FRI-SUN
XX AM TO XX PM
NEXT TUE AUG XX
TONIGHT XX PM-XX AM

\*\* See Application Guidelines Note 6.

## APPLICATION GUIDELINES

- Only 1 or 2 phases are to be used on a PCMS.
- The 1st phase (or both) should be selected from the "Road/Lane/Ramp Closure List" and the "Other Condition List".
- A 2nd phase can be selected from the "Action to Take/Effect on Travel, Location, General Warning, or Advance Notice Phase Lists".
- A Location Phase is necessary only if a distance or location is not included in the first phase selected.
- If two PCMS are used in sequence, they must be separated by a minimum of 1000 ft. Each PCMS shall be limited to two phases, and should be understandable by themselves.
- For advance notice, when the current date is within seven days of the actual work date, calendar days should be replaced with days of the week. Advance notification should typically be for no more than one week prior to the work.

## WORDING ALTERNATIVES

- The words RIGHT, LEFT and ALL can be interchanged as appropriate.
- Roadway designations IH, US, SH, FM and LP can be interchanged as appropriate.
- EAST, WEST, NORTH and SOUTH (or abbreviations E, W, N and S) can be interchanged as appropriate.
- Highway names and numbers replaced as appropriate.
- ROAD, HIGHWAY and FREEWAY can be interchanged as needed.
- AHEAD may be used instead of distances if necessary.
- FT and MI, MILE and MILES interchanged as appropriate.
- AT, BEFORE and PAST interchanged as needed.
- Distances or AHEAD can be eliminated from the message if a location phase is used.

PCMS SIGNS WITHIN THE R.O.W. SHALL BE BEHIND GUARDRAIL OR CONCRETE BARRIER OR SHALL HAVE A MINIMUM OF FOUR (4) PLASTIC DRUMS PLACED PERPENDICULAR TO TRAFFIC ON THE UPSTREAM SIDE OF THE PCMS, WHEN EXPOSED TO ONE DIRECTION OF TRAFFIC. WHEN EXPOSED TO TWO WAY TRAFFIC, THE FOUR DRUMS SHOULD BE PLACED WITH ONE DRUM AT EACH OF THE FOUR CORNERS OF THE UNIT.

## FULL MATRIX PCMS SIGNS

- When Full Matrix PCMS signs are used, the character height and legibility/visibility requirements shall be maintained as listed in Note 15 under "PORTABLE CHANGEABLE MESSAGE SIGNS" above.
- When symbol signs, such as the "Flagger Symbol" (CW20-7) are represented graphically on the Full Matrix PCMS sign and, with the approval of the Engineer, it shall maintain the legibility/visibility requirement listed above.
- When symbol signs are represented graphically on the Full Matrix PCMS, they shall only supplement the use of the static sign represented, and shall not substitute for, or replace that sign.
- A full matrix PCMS may be used to simulate a flashing arrow board provided it meets the visibility, flash rate and dimming requirements on BC(7), for the same size arrow.

DISCLAIMER: The use of this standard is governed by the "Texas Engineering Practice Act". No warranty of any kind is made by TxDOT for any purpose whatsoever. TxDOT assumes no responsibility for the conversion of this standard to other formats for incorrect or incomplete information resulting from its use.

DATE: 10/14/2021 11:02:50 AM  
FILE: T:\DALAO\DALNEAO\Maint. Contracts\2022 RMC Folder\Tree Trimming and Brush Removal\6393-46-001\_East Tree Trimming & Brush Removal\Standards\bc-21.dgn

WORD OR PHRASE	ABBREVIATION	WORD OR PHRASE	ABBREVIATION
Access Road	ACCS RD	Major	MAJ
Alternate	ALT	Miles	MI
Avenue	AVE	Miles Per Hour	MPH
Best Route	BEST RTE	Minor	MNR
Boulevard	BLVD	Monday	MON
Bridge	BRDG	Normal	NORM
Canot	CANT	North	N
Center	CTR	Northbound	(route) N
Construction Ahead	CONST AHD	Parking	PKING
CROSSING	XING	Road	RD
Detour Route	DETOUR RTE	Right Lane	RT LN
Do Not	DONT	Saturday	SAT
East	E	Service Road	SERV RD
Eastbound	(route) E	Shoulder	SHLDR
Emergency	EMER	Slippery	SLIP
Emergency Vehicle	EMER VEH	South	S
Entrance, Enter	ENT	Southbound	(route) S
Express Lane	EXP LN	Speed	SPD
Expressway	EXPWY	Street	ST
XXXX Feet	XXXX FT	Sunday	SUN
Fog Ahead	FOG AHD	Telephone	PHONE
Freeway	FRWY, FWY	Temporary	TEMP
Freeway Blocked	FWY BLKD	Thursday	THURS
Friday	FRI	To Downtown	TO DWNTN
Hazardous Driving	HAZ DRIVING	Traffic	TRAF
Hazardous Material	HAZMAT	Travelers	TRVLR
High-Occupancy Vehicle	HOV	Tuesday	TUES
Highway	Hwy	Time Minutes	TIME MIN
Hour(s)	HR, HRS	Upper Level	UPR LEVEL
Information	INFO	Vehicles (s)	VEH, VEHS
It Is	ITS	Warning	WARN
Junction	JCT	Wednesday	WED
Left	LFT	Weight Limit	WT LIMIT
Left Lane	LFT LN	West	W
Lane Closed	LN CLOSED	Westbound	(route) W
Lower Level	LWR LEVEL	Wet Pavement	WET PVMT
Maintenance	MAINT	Will Not	WONT

Roadway designation # IH-number, US-number, SH-number, FM-number



## BARRICADE AND CONSTRUCTION PORTABLE CHANGEABLE MESSAGE SIGN (PCMS)

BC (6) - 21

FILE:	bc-21.dgn	DN:	TxDOT	CR:	TxDOT	DW:	TxDOT	CK:	TxDOT
© TxDOT	November 2002	CONT:	6393	SECT:	46	JOB:	001	REVISIONS:	IHO030
9-07	8-14	DIST:	18	COUNTY:	DALLAS	SHEET NO.:	14		
7-13	5-21								

DISCLAIMER: The use of this standard is governed by the "Texas Engineering Practice Act". No warranty of any kind is made by TxDOT for any purpose whatsoever. TxDOT assumes no responsibility for the conversion of this standard to other formats or for incorrect results or damages resulting from its use.  
 DATE: 10/14/2021 11:02:53 AM  
 FILE: T:\DALAO\DALNEAO\Maint. Contracts\2022 RMC Folder\Tree Trimming and Brush Removal\Standards\bc-21.dgn

- Barrier Reflectors shall be pre-qualified, and conform to the color and reflectivity requirements of DMS-8600. A list of prequalified Barrier Reflectors can be found at the Material Producer List web address shown on BC(1).
- Color of Barrier Reflectors shall be as specified in the TMUTCD. The cost of the reflectors shall be considered subsidiary to Item 512.

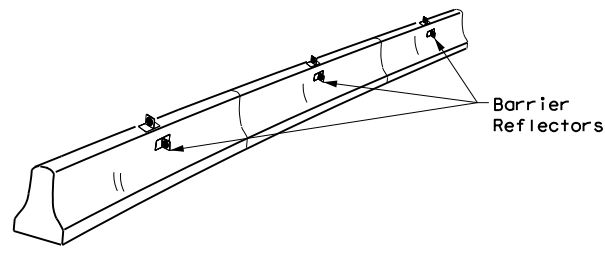

**CONCRETE TRAFFIC BARRIER (CTB)**

- Where traffic is on one side of the CTB, two (2) Barrier Reflectors shall be mounted in approximately the midsection of each section of CTB. An alternate mounting location is uniformly spaced at one end of each CTB. This will allow for attachment of a barrier grapple without damaging the reflector. The Barrier Reflector mounted on the side of the CTB shall be located directly below the reflector mounted on top of the barrier, as shown in the detail above.
- Where CTB separates two-way traffic, three barrier reflectors shall be mounted on each section of CTB. The reflector unit on top shall have two yellow reflective faces (Bi-Directional) while the reflectors on each side of the barrier shall have one yellow reflective face, as shown in the detail above.
- When CTB separates traffic traveling in the same direction, no barrier reflectors will be required on top of the CTB.
- Barrier Reflector units shall be yellow or white in color to match the edgeline being supplemented.
- Maximum spacing of Barrier Reflectors is forty (40) feet.
- Pavement markers or temporary flexible-reflective roadway marker tabs shall NOT be used as CTB delineation.
- Attachment of Barrier Reflectors to CTB shall be per manufacturer's recommendations.
- Missing or damaged Barrier Reflectors shall be replaced as directed by the Engineer.
- Single slope barriers shall be delineated as shown on the above detail.

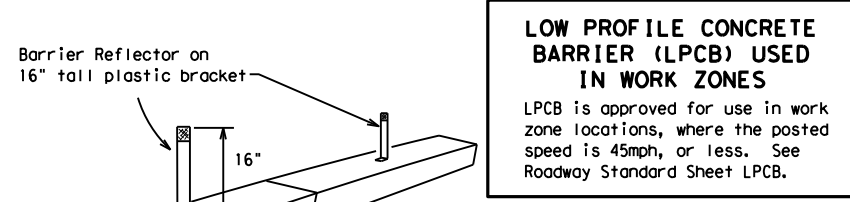

**LOW PROFILE CONCRETE BARRIER (LPCB) USED IN WORK ZONES**  
 LPCB is approved for use in work zone locations, where the posted speed is 45mph, or less. See Roadway Standard Sheet LPCB.

**LOW PROFILE CONCRETE BARRIER (LPCB)**

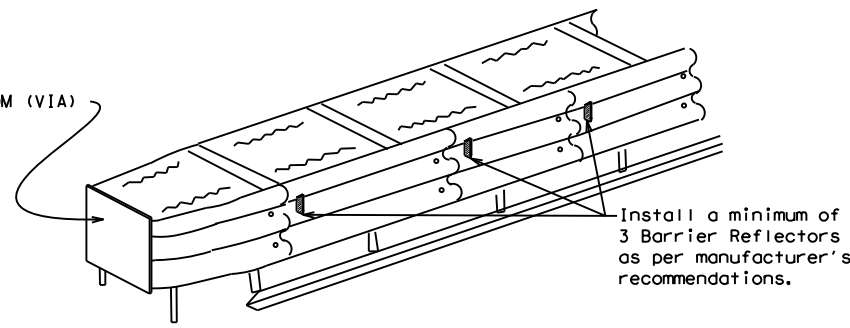

**DELINEATION OF END TREATMENTS**

**END TREATMENTS FOR CTB'S USED IN WORK ZONES**  
 End treatments used on CTB's in work zones shall meet the appropriate crashworthy standards as defined in the Manual for Assessing Safety Hardware (MASH). Refer to the CWZTCD List for approved end treatments and manufacturers.

**BARRIER REFLECTORS FOR CONCRETE TRAFFIC BARRIER AND ATTENUATORS**

**WARNING LIGHTS**

- Warning lights shall meet the requirements of the TMUTCD.
- Warning lights shall NOT be installed on barricades.
- Type A-Low Intensity Flashing Warning Lights are commonly used with drums. They are intended to warn of or mark a potentially hazardous area. Their use shall be as indicated on this sheet and/or other sheets of the plans by the designation "FL". The Type A Warning Lights shall not be used with signs manufactured with Type B<sub>FL</sub> or C<sub>FL</sub> Sheeting meeting the requirements of Departmental Material Specification DMS-8300.
- Type-C and Type D 360 degree Steady Burn Lights are intended to be used in a series for delineation to supplement other traffic control devices. Their use shall be as indicated on this sheet and/or other sheets of the plans by the designation "SB".
- The Engineer/Inspector or the plans shall specify the location and type of warning lights to be installed on the traffic control devices.
- When required by the Engineer, the Contractor shall furnish a copy of the warning lights certification. The warning light manufacturer will certify the warning lights meet the requirements of the latest ITE Purchase Specifications for Flashing and Steady-Burn Warning Lights.
- When used to delineate curves, Type-C and Type D Steady Burn Lights should only be placed on the outside of the curve, not the inside.
- The location of warning lights and warning reflectors on drums shall be as shown elsewhere in the plans.

**WARNING LIGHTS MOUNTED ON PLASTIC DRUMS**

- Type A flashing warning lights are intended to warn drivers that they are approaching or are in a potentially hazardous area.
- Type A random flashing warning lights are not intended for delineation and shall not be used in a series.
- A series of sequential flashing warning lights placed on channelizing devices to form a merging taper may be used for delineation. If used, the successive flashing of the sequential warning lights should occur from the beginning of the taper to the end of the merging taper in order to identify the desired vehicle path. The rate of flashing for each light shall be 65 flashes per minute, plus or minus 10 flashes.
- Type C and D steady-burn warning lights are intended to be used in a series to delineate the edge of the travel lane on detours, on lane changes, on lane closures, and on other similar conditions.
- Type A, Type C and Type D warning lights shall be installed at locations as detailed on other sheets in the plans.
- Warning lights shall not be installed on a drum that has a sign, chevron or vertical panel.
- The maximum spacing for warning lights on drums should be identical to the channelizing device spacing.

**WARNING REFLECTORS MOUNTED ON PLASTIC DRUMS AS A SUBSTITUTE FOR TYPE C (STEADY BURN) WARNING LIGHTS**

- A warning reflector or approved substitute may be mounted on a plastic drum as a substitute for a Type C, steady burn warning light at the discretion of the Contractor unless otherwise noted in the plans.
- The warning reflector shall be yellow in color and shall be manufactured using a sign substrate approved for use with plastic drums listed on the CWZTCD.
- The warning reflector shall have a minimum retroreflective surface area (one-side) of 30 square inches.
- Round reflectors shall be fully reflectorized, including the area where attached to the drum.
- Square substrates must have a minimum of 30 square inches of reflectorized sheeting. They do not have to be reflectorized where it attaches to the drum.
- The side of the warning reflector facing approaching traffic shall have sheeting meeting the color and retroreflectivity requirements for DMS 8300-Type B or Type C.
- When used near two-way traffic, both sides of the warning reflector shall be reflectorized.
- The warning reflector should be mounted on the side of the handle nearest approaching traffic.
- The maximum spacing for warning reflectors should be identical to the channelizing device spacing requirements.

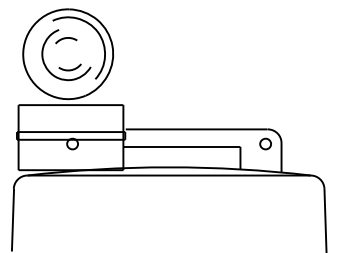

Type C Warning Light or approved substitute mounted on a drum adjacent to the travel way.

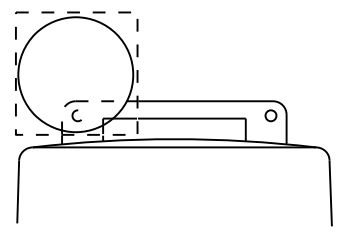

Warning reflector may be round or square. Must have a yellow reflective surface area of at least 30 square inches

Arrow Boards may be located behind channelizing devices in place for a shoulder taper or merging taper, otherwise they shall be delineated with four (4) channelizing devices placed perpendicular to traffic on the upstream side of traffic.

- The Flashing Arrow Board should be used for all lane closures on multi-lane roadways, or slow moving maintenance or construction activities on the travel lanes.
- Flashing Arrow Boards should not be used on two-lane, two-way roadways, detours, diversions or work on shoulders unless the "CAUTION" display (see detail below) is used.
- The Engineer/Inspector shall choose all appropriate signs, barricades and/or other traffic control devices that should be used in conjunction with the Flashing Arrow Board.
- The Flashing Arrow Board should be able to display the following symbols:

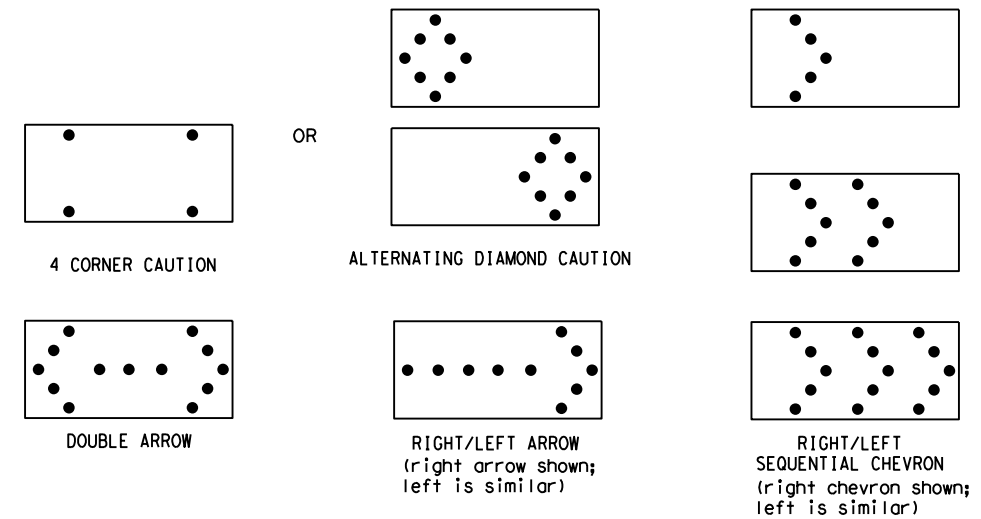

- The "CAUTION" display consists of four corner lamps flashing simultaneously, or the Alternating Diamond Caution mode as shown.
- The straight line caution display is NOT ALLOWED.
- The Flashing Arrow Board shall be capable of minimum 50 percent dimming from rated lamp voltage. The flashing rate of the lamps shall not be less than 25 nor more than 40 flashes per minute.
- Minimum lamp "on time" shall be approximately 50 percent for the flashing arrow and equal intervals of 25 percent for each sequential phase of the flashing chevron.
- The sequential arrow display is NOT ALLOWED.
- The flashing arrow display is the TxDOT standard; however, the sequential chevron display may be used during daylight operations.
- The Flashing Arrow Board shall be mounted on a vehicle, trailer or other suitable support.
- A Flashing Arrow Board SHALL NOT BE USED to laterally shift traffic.
- A full matrix PCMS may be used to simulate a Flashing Arrow Board provided it meets visibility, flash rate and dimming requirements on this sheet for the same size arrow.
- Minimum mounting height of trailer mounted Arrow Boards should be 7 feet from roadway to bottom of panel.

REQUIREMENTS			
TYPE	MINIMUM SIZE	MINIMUM NUMBER OF PANEL LAMPS	MINIMUM VISIBILITY DISTANCE
B	30 x 60	13	3/4 mile
C	48 x 96	15	1 mile

**ATTENTION**  
 Flashing Arrow Boards shall be equipped with automatic dimming devices.

WHEN NOT IN USE, REMOVE THE ARROW BOARD FROM THE RIGHT-OF-WAY OR PLACE THE ARROW BOARD BEHIND CONCRETE TRAFFIC BARRIER OR GUARDRAIL.

**FLASHING ARROW BOARDS**

SHEET 7 OF 12

**TRUCK-MOUNTED ATTENUATORS**

- Truck-mounted attenuators (TMA) used on TxDOT facilities must meet the requirements outlined in the Manual for Assessing Safety Hardware (MASH).
- Refer to the CWZTCD for the requirements of Level 2 or Level 3 TMAs.
- Refer to the CWZTCD for a list of approved TMAs.
- TMAs are required on freeways unless otherwise noted in the plans.
- A TMA should be used anytime that it can be positioned 30 to 100 feet in advance of the area of crew exposure without adversely affecting the work performance.
- The only reason a TMA should not be required is when a work area is spread down the roadway and the work crew is an extended distance from the TMA.

Texas Department of Transportation  
 Traffic Safety Division Standard

**BARRICADE AND CONSTRUCTION ARROW PANEL, REFLECTORS, WARNING LIGHTS & ATTENUATOR**

**BC (7) -21**

FILE:	bc-21.dgn	DN:	TxDOT	CR:	TxDOT	DW:	TxDOT	CK:	TxDOT
©TxDOT	November 2002	CONT	SECT	JOB	HIGHWAY				
REVISIONS		6393	46	001	IH0030				
9-07	8-14	DIST	COUNTY	SHEET NO.					
7-13	5-21	18	DALLAS	15					

DISCLAIMER: The use of this standard is governed by the "Texas Engineering Practice Act". No warranty of any kind is made by TxDOT for any purpose whatsoever. TxDOT assumes no responsibility for the conversion of this standard to other formats or for incorrect results or damages resulting from its use.  
 DATE: 10/14/2021 11:02:55 AM  
 FILE: T:\DALAO\DALNEAO\Maint. Contracts\2022 RMC Folder\Tree Trimming & Brush Removal\Standards\bc-21.dgn

**GENERAL NOTES**

- For long term stationary work zones on freeways, drums shall be used as the primary channelizing device.
- For intermediate term stationary work zones on freeways, drums should be used as the primary channelizing device but may be replaced in tangent sections by vertical panels, or 42" two-piece cones. In tangent sections, one-piece cones may be used with the approval of the Engineer but only if personnel are present on the project at all times to maintain the cones in proper position and location.
- For short term stationary work zones on freeways, drums are the preferred channelizing device but may be replaced in tapers, transitions and tangent sections by vertical panels, two-piece cones or one-piece cones as approved by the Engineer.
- Drums and all related items shall comply with the requirements of the current version of the "Texas Manual on Uniform Traffic Control Devices" (TMUTCD) and the "Compliant Work Zone Traffic Control Devices List" (CWZTCD).
- Drums, bases, and related materials shall exhibit good workmanship and shall be free from objectionable marks or defects that would adversely affect their appearance or serviceability.
- The Contractor shall have a maximum of 24 hours to replace any plastic drums identified for replacement by the Engineer/Inspector. The replacement device must be an approved device.

**GENERAL DESIGN REQUIREMENTS**

- Pre-qualified plastic drums shall meet the following requirements:
- Plastic drums shall be a two-piece design; the "body" of the drum shall be the top portion and the "base" shall be the bottom.
  - The body and base shall lock together in such a manner that the body separates from the base when impacted by a vehicle traveling at a speed of 20 MPH or greater but prevents accidental separation due to normal handling and/or air turbulence created by passing vehicles.
  - Plastic drums shall be constructed of lightweight flexible, and deformable materials. The Contractor shall NOT use metal drums or single piece plastic drums as channelization devices or sign supports.
  - Drums shall present a profile that is a minimum of 18 inches in width at the 36 inch height when viewed from any direction. The height of drum unit (body installed on base) shall be a minimum of 36 inches and a maximum of 42 inches.
  - The top of the drum shall have a built-in handle for easy pickup and shall be designed to drain water and not collect debris. The handle shall have a minimum of two widely spaced 9/16 inch diameter holes to allow attachment of a warning light, warning reflector unit or approved compliant sign.
  - The exterior of the drum body shall have a minimum of four alternating orange and white retroreflective circumferential stripes not less than 4 inches nor greater than 8 inches in width. Any non-reflectORIZED space between any two adjacent stripes shall not exceed 2 inches in width.
  - Bases shall have a maximum width of 36 inches, a maximum height of 4 inches, and a minimum of two footholds of sufficient size to allow base to be held down while separating the drum body from the base.
  - Plastic drums shall be constructed of ultra-violet stabilized, orange, high-density polyethylene (HDPE) or other approved material.
  - Drum body shall have a maximum unballasted weight of 11 lbs.
  - Drum and base shall be marked with manufacturer's name and model number.

**RETROREFLECTIVE SHEETING**

- The stripes used on drums shall be constructed of sheeting meeting the color and retroreflectivity requirements of Departmental Materials Specification DMS-8300, "Sign Face Materials." Type A or Type B reflective sheeting shall be supplied unless otherwise specified in the plans.
- The sheeting shall be suitable for use on and shall adhere to the drum surface such that, upon vehicular impact, the sheeting shall remain adhered in-place and exhibit no delaminating, cracking, or loss of retroreflectivity other than that loss due to abrasion of the sheeting surface.

**BALLAST**

- Unballasted bases shall be large enough to hold up to 50 lbs. of sand. This base, when filled with the ballast material, should weigh between 35 lbs (minimum) and 50 lbs (maximum). The ballast may be sand in one to three sandbags separate from the base, sand in a sand-filled plastic base, or other ballasting devices as approved by the Engineer. Stacking of sandbags will be allowed, however height of sandbags above pavement surface may not exceed 12 inches.
- Bases with built-in ballast shall weigh between 40 lbs. and 50 lbs. Built-in ballast can be constructed of an integral crumb rubber base or a solid rubber base.
- Recycled truck tire sidewalls may be used for ballast on drums approved for this type of ballast on the CWZTCD list.
- The ballast shall not be heavy objects, water, or any material that would become hazardous to motorists, pedestrians, or workers when the drum is struck by a vehicle.
- When used in regions susceptible to freezing, drums shall have drainage holes in the bottoms so that water will not collect and freeze becoming a hazard when struck by a vehicle.
- Ballast shall not be placed on top of drums.
- Adhesives may be used to secure base of drums to pavement.

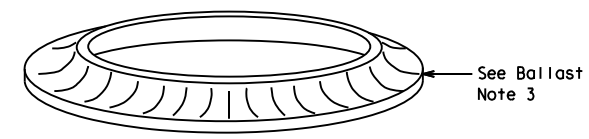
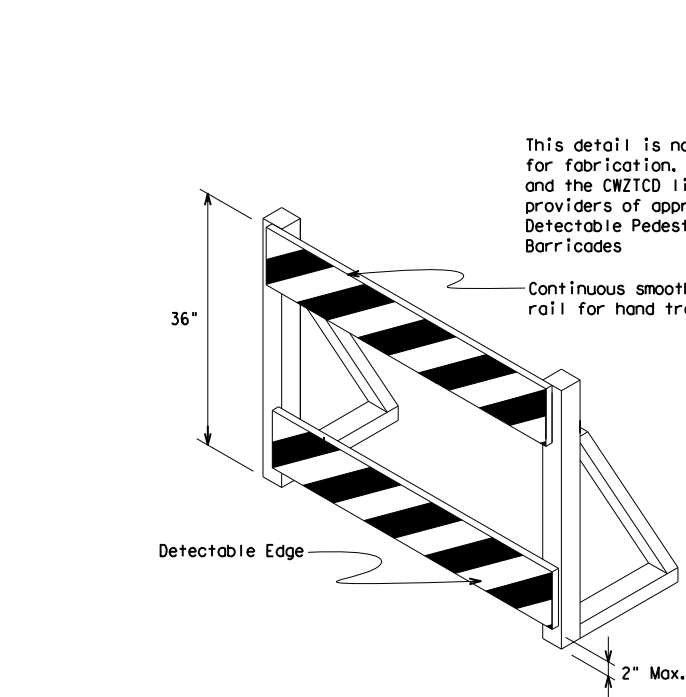
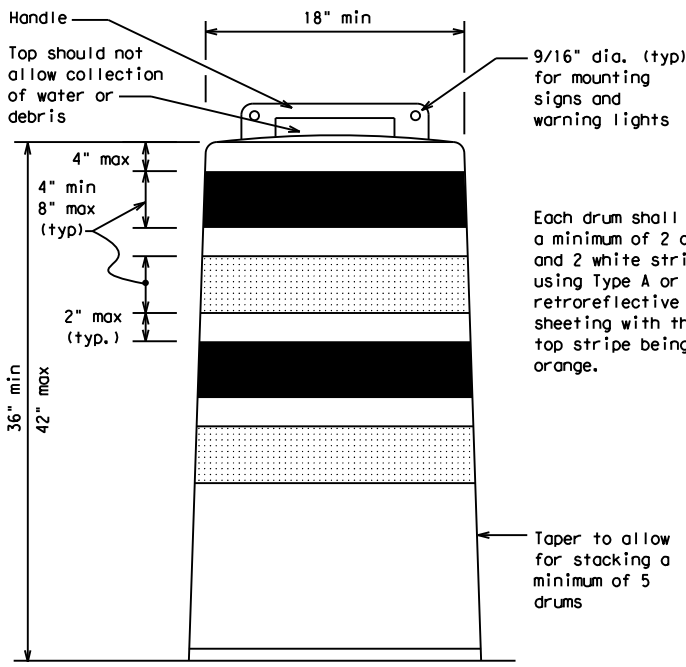

**DETECTABLE PEDESTRIAN BARRICADES**

- When existing pedestrian facilities are disrupted, closed, or relocated in a TTC zone, the temporary facilities shall be detectable and include accessibility features consistent with the features present in the existing pedestrian facility. Refer to WZ(BTS-2) for Pedestrian Control requirements for Sidewalk Diversions, Sidewalk Detours and Crosswalk Closures.
- Where pedestrians with visual disabilities normally use the closed sidewalk, a Detectable Pedestrian Barricade shall be placed across the full width of the closed sidewalk instead of a Type 3 Barricade.
- Detectable pedestrian barricades similar to the one pictured above, longitudinal channelizing devices, some concrete barriers, and wood or chain link fencing with a continuous detectable edging can satisfactorily delineate a pedestrian path.
- Tape, rope, or plastic chain strung between devices are not detectable, do not comply with the design standards in the "Americans with Disabilities Act Accessibility Guidelines (ADAAG)" and should not be used as a control for pedestrian movements.
- Warning lights shall not be attached to detectable pedestrian barricades.
- Detectable pedestrian barricades should use 8" nominal barricade rails as shown on BC(10) provided that the top rail provides a smooth continuous rail suitable for hand trailing with no splinters, burrs, or sharp edges.

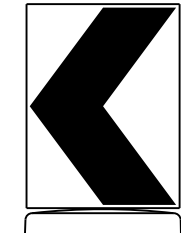

18" x 24" Sign  
(Maximum Sign Dimension)  
Chevron CW1-8, Opposing Traffic Lane  
Divider, Driveway sign D70a, Keep Right  
R4 series or other signs as approved  
by Engineer

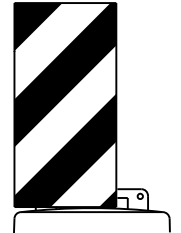

12" x 24"  
Vertical Panel  
mount with diagonals  
sloping down towards  
travel way

Plywood, Aluminum or Metal sign  
substrates shall NOT be used on  
plastic drums

**SIGNS, CHEVRONS, AND VERTICAL PANELS MOUNTED ON PLASTIC DRUMS**

- Signs used on plastic drums shall be manufactured using substrates listed on the CWZTCD.
- Chevrons and other work zone signs with an orange background shall be manufactured with Type B<sub>FL</sub> or Type C<sub>FL</sub> Orange sheeting meeting the color and retroreflectivity requirements of DMS-8300, "Sign Face Material," unless otherwise specified in the plans.
- Vertical Panels shall be manufactured with orange and white sheeting meeting the requirements of DMS-8300 Type A or Type B. Diagonal stripes on Vertical Panels shall slope down toward the intended traveled lane.
- Other sign messages (text or symbolic) may be used as approved by the Engineer. Sign dimensions shall not exceed 18 inches in width or 24 inches in height, except for the R9 series signs discussed in note 8 below.
- Signs shall be installed using a 1/2 inch bolt (nominal) and nut, two washers, and one locking washer for each connection.
- Mounting bolts and nuts shall be fully engaged and adequately torqued. Bolts should not extend more than 1/2 inch beyond nuts.
- Chevrons may be placed on drums on the outside of curves, on merging tapers or on shifting tapers. When used in these locations, they may be placed on every drum or spaced not more than on every third drum. A minimum of three (3) should be used at each location called for in the plans.
- R9-9, R9-10, R9-11 and R9-11a Sidewalk Closed signs which are 24 inches wide may be mounted on plastic drums, with approval of the Engineer.

SHEET 8 OF 12



**BARRICADE AND CONSTRUCTION CHANNELIZING DEVICES**

**BC (8) - 21**

FILE:	bc-21.dgn	DN:	TxDOT	CR:	TxDOT	DW:	TxDOT	CK:	TxDOT
© TxDOT	November 2002	CONT	SECT	JOB	HIGHWAY				
REVISIONS		6393	46	001	IH0030				
4-03	8-14	DIST	COUNTY	SHEET NO.					
9-07	5-21	18	DALLAS	16					
7-13									

DISCLAIMER: The use of this standard is governed by the "Texas Engineering Practice Act". No warranty of any kind is made by TxDOT for any purpose whatsoever. TxDOT assumes no responsibility for the conversion of this standard to other formats or for incorrect results or damages resulting from its use.

DATE: 10/14/2021 11:02:58 AM  
 FILE: T:\DALAO\DALNEAO\Maint. Contracts\Tree Trimming and Brush Removal\Standards\bc-21.dgn

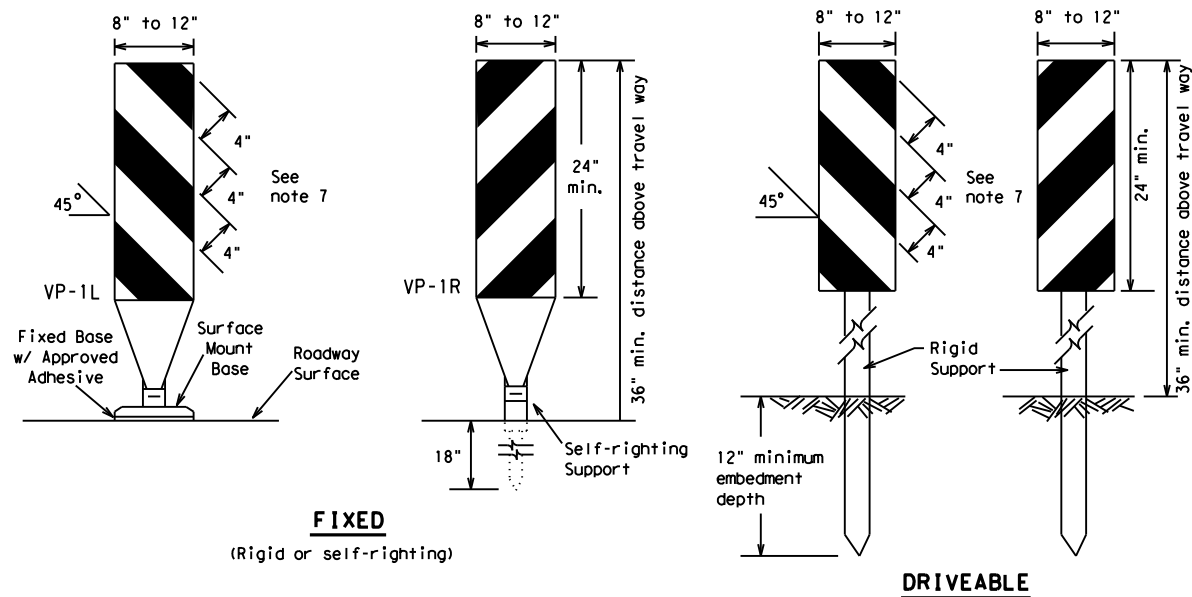

**FIXED**  
(Rigid or self-righting)

**DRIVEABLE**

- Vertical Panels (VP's) are normally used to channelize traffic or divide opposing lanes of traffic.
- VP's may be used in daytime or nighttime situations. They may be used at the edge of shoulder drop-offs and other areas such as lane transitions where positive daytime and nighttime delineation is required. The Engineer/Inspector shall refer to the Roadway Design Manual for additional requirements on the use VP's for drop-offs.
- VP's should be mounted back to back if used at the edge of cuts adjacent to two-way two lane roadways. Stripes are to be reflective orange and reflective white and should always slope downward toward the travel lane.
- VP's used on expressways and freeways or other high speed roadways, may have more than 270 square inches of retroreflective area facing traffic.
- Self-righting supports are available with portable base. See "Compliant Work Zone Traffic Control Devices List" (CWZTCD).
- Sheeting for the VP's shall be retroreflective Type A or Type B conforming to Departmental Material Specification DMS-8300, unless noted otherwise.
- Where the height of reflective material on the vertical panel is 36 inches or greater, a panel stripe of 6 inches shall be used.

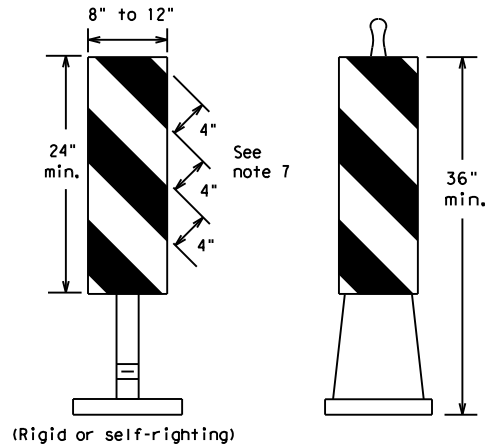

**PORTABLE**

**VERTICAL PANELS (VPs)**

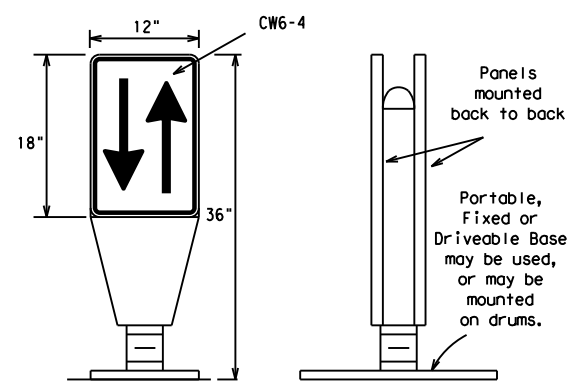

**OPPOSING TRAFFIC LANE DIVIDERS (OTLD)**

- Opposing Traffic Lane Dividers (OTLD) are delineation devices designed to convert a normal one-way roadway section to two-way operation. OTLD's are used on temporary centerlines. The upward and downward arrows on the sign's face indicate the direction of traffic on either side of the divider. The base is secured to the pavement with an adhesive or rubber weight to minimize movement caused by a vehicle impact or wind gust.
- The OTLD may be used in combination with 42" cones or VPs.
- Spacing between the OTLD shall not exceed 500 feet. 42" cones or VPs placed between the OTLD's should not exceed 100 foot spacing.
- The OTLD shall be orange with a black non-reflective legend. Sheeting for the OTLD shall be retroreflective Type B<sub>FL</sub> or Type C<sub>FL</sub> conforming to Departmental Material Specification DMS-8300, unless noted otherwise. The legend shall meet the requirements of DMS-8300.

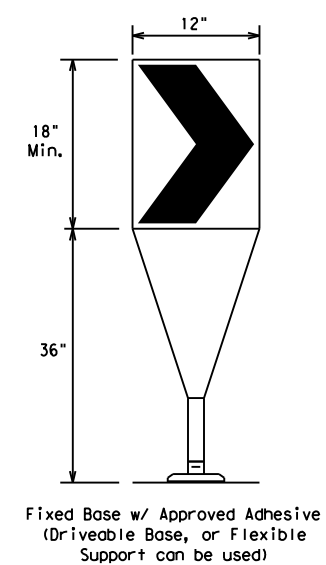

- The chevron shall be a vertical rectangle with a minimum size of 12 by 18 inches.
- Chevrons are intended to give notice of a sharp change of alignment with the direction of travel and provide additional emphasis and guidance for vehicle operators with regard to changes in horizontal alignment of the roadway.
- Chevrons, when used, shall be erected on the outside of a sharp curve or turn, or on the far side of an intersection. They shall be in line with and at right angles to approaching traffic. Spacing should be such that the motorist always has three in view, until the change in alignment eliminates its need.
- To be effective, the chevron should be visible for at least 500 feet.
- Chevrons shall be orange with a black nonreflective legend. Sheeting for the chevron shall be retroreflective Type B<sub>FL</sub> or Type C<sub>FL</sub> conforming to Departmental Material Specification DMS-8300, unless noted otherwise. The legend shall meet the requirements of DMS-8300.
- For Long Term Stationary use on tapers or transitions on freeways and divided highways, self-righting chevrons may be used to supplement plastic drums but not to replace plastic drums.

**CHEVRONS**

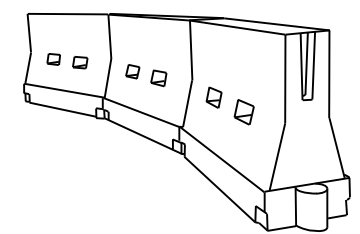

**LONGITUDINAL CHANNELIZING DEVICES (LCD)**

- LCDs are crashworthy, lightweight, deformable devices that are highly visible, have good target value and can be connected together. They are not designed to contain or redirect a vehicle on impact.
- LCDs may be used instead of a line of cones or drums.
- LCDs shall be placed in accordance to application and installation requirements specific to the device, and used only when shown on the CWZTCD list.
- LCDs should not be used to provide positive protection for obstacles, pedestrians or workers.
- LCDs shall be supplemented with retroreflective delineation as required for temporary barriers on BC(7) when placed roughly parallel to the travel lanes.
- LCDs used as barricades placed perpendicular to traffic should have at least one row of reflective sheeting meeting the requirements for barricade rails as shown on BC(10). Place reflective sheeting near the top of the LCD along the full length of the device.

**WATER BALLASTED SYSTEMS USED AS BARRIERS**

- Water ballasted systems used as barriers shall not be used solely to channelize road users, but also to protect the work space per the appropriate Manual for Assessing Safety Hardware (MASH) crashworthiness requirements based on roadway speed and barrier application.
- Water ballasted systems used to channelize vehicular traffic shall be supplemented with retroreflective delineation or channelizing devices to improve daytime/nighttime visibility. They may also be supplemented with pavement markings.
- Water ballasted systems used as barriers shall be placed in accordance to application and installation requirements specific to the device, and used only when shown on the CWZTCD list.
- Water ballasted systems used as barriers should not be used for a merging taper except in low speed (less than 45 MPH) urban areas. When used on a taper in a low speed urban area, the taper shall be delineated and the taper length should be designed to optimize road user operations considering the available geometric conditions.
- When water ballasted systems used as barriers have blunt ends exposed to traffic, they should be attenuated as per manufacturer recommendations or flared to a point outside the clear zone.

If used to channelize pedestrians, longitudinal channelizing devices or water ballasted systems must have a continuous detectable bottom for users of long canes and the top of the unit shall not be less than 32 inches in height.

**HOLLOW OR WATER BALLASTED SYSTEMS USED AS LONGITUDINAL CHANNELIZING DEVICES OR BARRIERS**

**GENERAL NOTES**

- Work Zone channelizing devices illustrated on this sheet may be installed in close proximity to traffic and are suitable for use on high or low speed roadways. The Engineer/Inspector shall ensure that spacing and placement is uniform and in accordance with the "Texas Manual on Uniform Traffic Control Devices" (TMUTCD).
- Channelizing devices shown on this sheet may have a driveable, fixed or portable base. The requirement for self-righting channelizing devices must be specified in the General Notes or other plan sheets.
- Channelizing devices on self-righting supports should be used in work zone areas where channelizing devices are frequently impacted by errant vehicles or vehicle related wind gusts making alignment of the channelizing devices difficult to maintain. Locations of these devices shall be detailed elsewhere in the plans. These devices shall conform to the TMUTCD and the "Compliant Work Zone Traffic Control Devices List" (CWZTCD).
- The Contractor shall maintain devices in a clean condition and replace damaged, nonreflective, faded, or broken devices and bases as required by the Engineer/Inspector. The Contractor shall be required to maintain proper device spacing and alignment.
- Portable bases shall be fabricated from virgin and/or recycled rubber. The portable bases shall weigh a minimum of 30 lbs.
- Pavement surfaces shall be prepared in a manner that ensures proper bonding between the adhesives, the fixed mount bases and the pavement surface. Adhesives shall be prepared and applied according to the manufacturer's recommendations.
- The installation and removal of channelizing devices shall not cause detrimental effects to the final pavement surfaces, including pavement surface discoloration or surface integrity. Driveable bases shall not be permitted on final pavement surfaces. The Engineer/Inspector shall approve all application and removal procedures of fixed bases.

Posted Speed	Formula	Minimum Desirable Taper Lengths **			Suggested Maximum Spacing of Channelizing Devices	
		10' Offset	11' Offset	12' Offset	On a Taper	On a Tangent
30	L = WS <sup>2</sup> / 60	150'	165'	180'	30'	60'
35		205'	225'	245'	35'	70'
40		265'	295'	320'	40'	80'
45	L = WS	450'	495'	540'	45'	90'
50		500'	550'	600'	50'	100'
55		550'	605'	660'	55'	110'
60		600'	660'	720'	60'	120'
65		650'	715'	780'	65'	130'
70		700'	770'	840'	70'	140'
75		750'	825'	900'	75'	150'
80		800'	880'	960'	80'	160'

\*\*Taper lengths have been rounded off.  
 L=Length of Taper (FT.) W=Width of Offset (FT.)  
 S=Posted Speed (MPH)

**SUGGESTED MAXIMUM SPACING OF CHANNELIZING DEVICES AND MINIMUM DESIRABLE TAPER LENGTHS**

SHEET 9 OF 12



**BARRICADE AND CONSTRUCTION CHANNELIZING DEVICES**

BC (9) - 21

FILE: bc-21.dgn	DN: TxDOT	CK: TxDOT	DW: TxDOT	CR: TxDOT
© TxDOT November 2002	CONT	SECT	JOB	HIGHWAY
REVISIONS	6393	46	001	IHO030
9-07 8-14	DIST	COUNTY	SHEET NO.	
7-13 5-21	18	DALLAS	17	

DATE: 10/14/2021 11:03:00 AM  
 FILE: T:\DALAO\DALNEAO\Maint. Contracts\2022 RMC Folder\Tree Trimming and Brush Removal\6393-46-001 East Tree Trimming & Brush Removal\Standards\bc-21.dgn  
 DISCLAIMER: The use of this standard is governed by the "Texas Engineering Practice Act". No warranty of any kind is made by TxDOT for any purpose whatsoever. TxDOT assumes no responsibility for the conversion of this standard to other formats or for incorrect results or damages resulting from its use.

**TYPE 3 BARRICADES**

1. Refer to the Compliant Work Zone Traffic Control Devices List (CWZTCD) for details of the Type 3 Barricades and a list of all materials used in the construction of Type 3 Barricades.
2. Type 3 Barricades shall be used at each end of construction projects closed to all traffic.
3. Barricades extending across a roadway should have stripes that slope downward in the direction toward which traffic must turn in detouring. When both right and left turns are provided, the chevron striping may slope downward in both directions from the center of the barricade. Where no turns are provided at a closed road, striping should slope downward in both directions toward the center of roadway.
4. Striping of rails, for the right side of the roadway, should slope downward to the left. For the left side of the roadway, striping should slope downward to the right.
5. Identification markings may be shown only on the back of the barricade rails. The maximum height of letters and/or company logos used for identification shall be 1".
6. Barricades shall not be placed parallel to traffic unless an adequate clear zone is provided.
7. Warning lights shall NOT be installed on barricades.
8. Where barricades require the use of weights to keep from turning over, the use of sandbags with dry, cohesionless sand is recommended. The sandbags will be tied shut to keep the sand from spilling and to maintain a constant weight. Sand bags shall not be stacked in a manner that covers any portion of a barricade rails reflective sheeting. Rock, concrete, iron, steel or other solid objects will NOT be permitted. Sandbags should weigh a minimum of 35 lbs and a maximum of 50 lbs. Sandbags shall be made of a durable material that tears upon vehicular impact. Rubber (such as tire inner tubes) shall not be used for sandbags. Sandbags shall only be placed along or upon the base supports of the device and shall not be suspended above ground level or hung with rope, wire, chains or other fasteners.
9. Sheeting for barricades shall be retroreflective Type A or Type B conforming to Departmental Material Specification DMS-8300 unless otherwise noted.

Barricades shall NOT be used as a sign support.



**TYPICAL STRIPING DETAIL FOR BARRICADE RAIL**



**TYPICAL PANEL DETAIL FOR SKID OR POST TYPE BARRICADES**

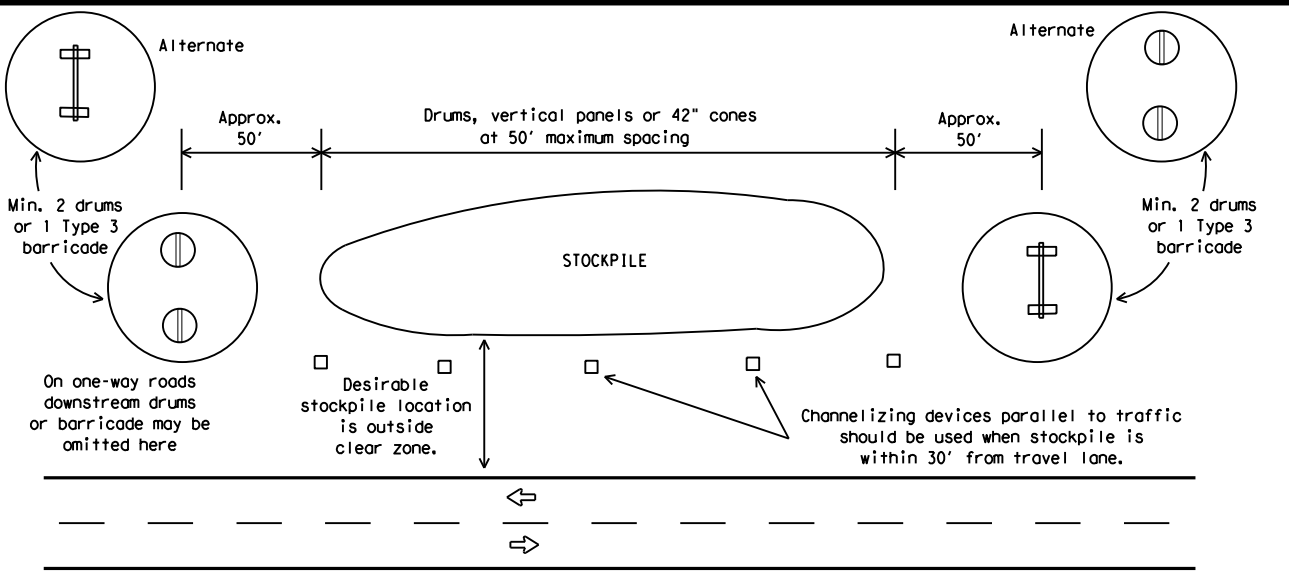

**TRAFFIC CONTROL FOR MATERIAL STOCKPILES**

Each roadway of a divided highway shall be barricaded in the same manner.

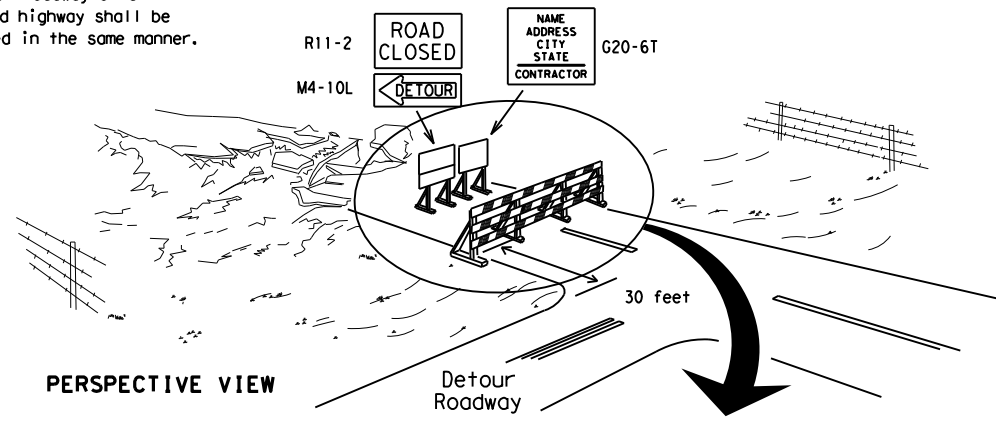

PERSPECTIVE VIEW

The three rails on Type 3 barricades shall be reflectorized orange and reflective white stripes on one side facing one-way traffic and both sides for two-way traffic. Barricade striping should slant downward in the direction of detour.

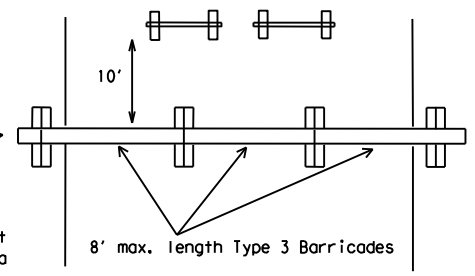

PLAN VIEW

1. Signs should be mounted on independent supports at a 7 foot mounting height in center of roadway. The signs should be a minimum of 10 feet behind Type 3 Barricades.
2. Advance signing shall be as specified elsewhere in the plans.

**TYPE 3 BARRICADE (POST AND SKID) TYPICAL APPLICATION**

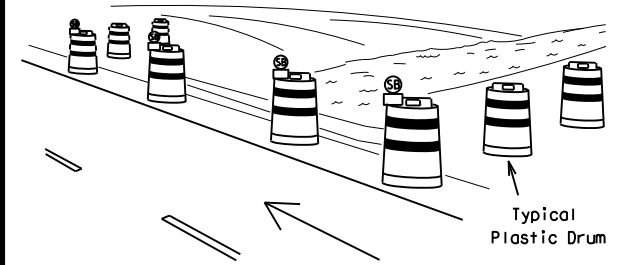

PERSPECTIVE VIEW

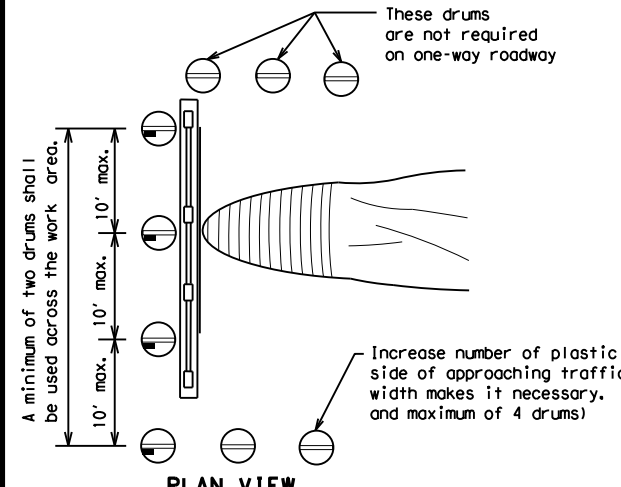

PLAN VIEW

**CULVERT WIDENING OR OTHER ISOLATED WORK WITHIN THE PROJECT LIMITS**

1. Where positive redirection capability is provided, drums may be omitted.
2. Plastic construction fencing may be used with drums for safety as required in the plans.
3. Vertical Panels on flexible support may be substituted for drums when the shoulder width is less than 4 feet.
4. When the shoulder width is greater than 12 feet, steady-burn lights may be omitted if drums are used.
5. Drums must extend the length of the culvert widening.

LEGEND	
	Plastic drum
	Plastic drum with steady burn light or yellow warning reflector
	Steady burn warning light or yellow warning reflector

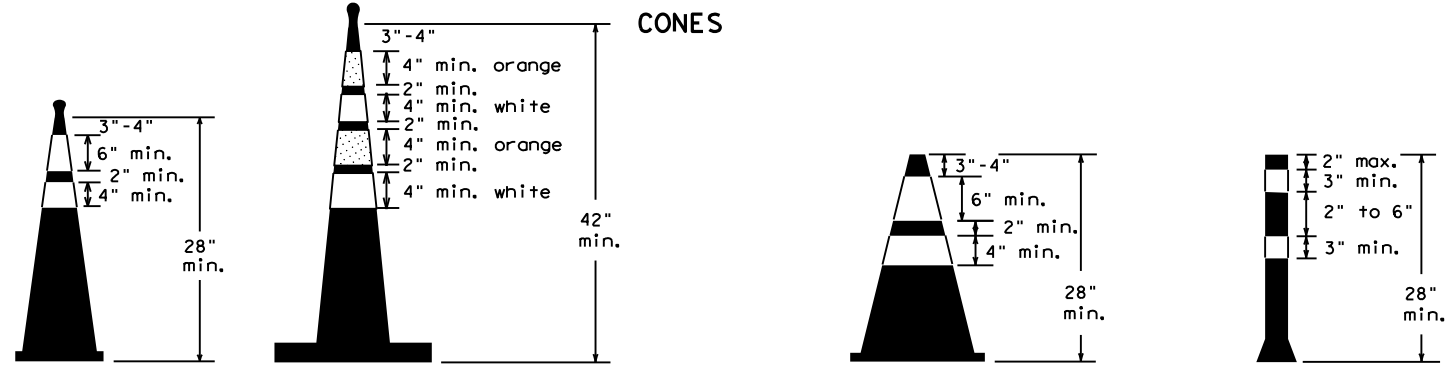

Two-Piece cones

One-Piece cones

Tubular Marker

28" Cones shall have a minimum weight of 9 1/2 lbs.  
 42" 2-piece cones shall have a minimum weight of 30 lbs. including base.

1. Traffic cones and tubular markers shall be predominantly orange, and meet the height and weight requirements shown above.
2. One-piece cones have the body and base of the cone molded in one consolidated unit. Two-piece cones have a cone shaped body and a separate rubber base, or ballast, that is added to keep the device upright and in place.
3. Two-piece cones may have a handle or loop extending up to 8" above the minimum height shown, in order to aid in retrieving the device.
4. Cones or tubular markers shall have white or white and orange reflective bands as shown above. The reflective bands shall have a smooth, sealed outer surface and meet the requirements of Departmental Material Specification DMS-8300 Type A or Type B.
5. 28" cones and tubular markers are generally suitable for short duration and short-term stationary work as defined on BC(4). These should not be used for intermediate-term or long-term stationary work unless personnel is on-site to maintain them in their proper upright position.
6. 42" two-piece cones, vertical panels or drums are suitable for all work zone durations.
7. Cones or tubular markers used on each project should be of the same size and shape.



**BARRICADE AND CONSTRUCTION CHANNELIZING DEVICES**

**BC (10) - 21**

FILE: bc-21.dgn	DN: TxDOT	CK: TxDOT	OW: TxDOT	CR: TxDOT
© TxDOT November 2002	CONT	SECT	JOB	HIGHWAY
REVISIONS	6393	46	001	IH0030
9-07 8-14	DIST	COUNTY	SHEET NO.	
7-13 5-21	18	DALLAS	18	



## WORK ZONE PAVEMENT MARKINGS

### GENERAL

- The Contractor shall be responsible for maintaining work zone and existing pavement markings, in accordance with the standard specifications and special provisions, on all roadways open to traffic within the CSJ limits unless otherwise stated in the plans.
- Color, patterns and dimensions shall be in conformance with the "Texas Manual on Uniform Traffic Control Devices" (TMUTCD).
- Additional supplemental pavement marking details may be found in the plans or specifications.
- Pavement markings shall be installed in accordance with the TMUTCD and as shown on the plans.
- When short term markings are required on the plans, short term markings shall conform with the TMUTCD, the plans and details as shown on the Standard Plan Sheet WZ(STPM).
- When standard pavement markings are not in place and the roadway is opened to traffic, DO NOT PASS signs shall be erected to mark the beginning of the sections where passing is prohibited and PASS WITH CARE signs at the beginning of sections where passing is permitted.
- All work zone pavement markings shall be installed in accordance with Item 662, "Work Zone Pavement Markings."

### RAISED PAVEMENT MARKERS

- Raised pavement markers are to be placed according to the patterns on BC(12).
- All raised pavement markers used for work zone markings shall meet the requirements of Item 672, "RAISED PAVEMENT MARKERS" and Departmental Material Specification DMS-4200 or DMS-4300.

### PREFABRICATED PAVEMENT MARKINGS

- Removable prefabricated pavement markings shall meet the requirements of DMS-8241.
- Non-removable prefabricated pavement markings (foil back) shall meet the requirements of DMS-8240.

### MAINTAINING WORK ZONE PAVEMENT MARKINGS

- The Contractor will be responsible for maintaining work zone pavement markings within the work limits.
- Work zone pavement markings shall be inspected in accordance with the frequency and reporting requirements of work zone traffic control device inspections as required by Form 599.
- The markings should provide a visible reference for a minimum distance of 300 feet during normal daylight hours and 160 feet when illuminated by automobile low-beam headlights at night, unless sight distance is restricted by roadway geometrics.
- Markings failing to meet this criteria within the first 30 days after placement shall be replaced at the expense of the Contractor as per Specification Item 662.

### REMOVAL OF PAVEMENT MARKINGS

- Pavement markings that are no longer applicable, could create confusion or direct a motorist toward or into the closed portion of the roadway shall be removed or obliterated before the roadway is opened to traffic.
- The above shall not apply to detours in place for less than three days, where flaggers and/or sufficient channelizing devices are used in lieu of markings to outline the detour route.
- Pavement markings shall be removed to the fullest extent possible, so as not to leave a discernable marking. This shall be by any method approved by TxDOT Specification Item 677 for "Eliminating Existing Pavement Markings and Markers".
- The removal of pavement markings may require resurfacing or seal coating portions of the roadway as described in Item 677.
- Subject to the approval of the Engineer, any method that proves to be successful on a particular type pavement may be used.
- Blast cleaning may be used but will not be required unless specifically shown in the plans.
- Over-painting of the markings SHALL NOT BE permitted.
- Removal of raised pavement markers shall be as directed by the Engineer.
- Removal of existing pavement markings and markers will be paid for directly in accordance with Item 677, "ELIMINATING EXISTING PAVEMENT MARKINGS AND MARKERS," unless otherwise stated in the plans.
- Black-out marking tape may be used to cover conflicting existing markings for periods less than two weeks when approved by the Engineer.

## Temporary Flexible-Reflective Roadway Marker Tabs

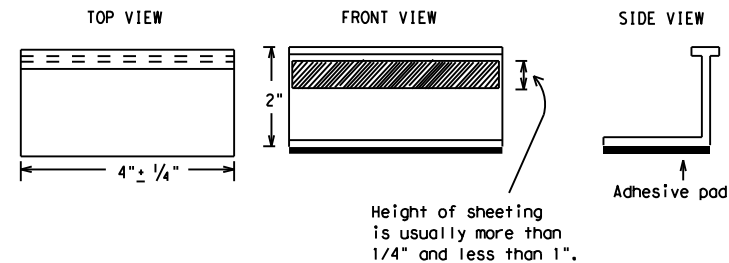

**STAPLES OR NAILS SHALL NOT BE USED TO SECURE  
TEMPORARY FLEXIBLE-REFLECTIVE ROADWAY MARKER  
TABS TO THE PAVEMENT SURFACE**

- Temporary flexible-reflective roadway marker tabs used as guidemarks shall meet the requirements of DMS-8242.
- Tabs detailed on this sheet are to be inspected and accepted by the Engineer or designated representative. Sampling and testing is not normally required, however at the option of the Engineer, either "A" or "B" below may be imposed to assure quality before placement on the roadway.
  - Select five (5) or more tabs at random from each lot or shipment and submit to the Construction Division, Materials and Pavement Section to determine specification compliance.
  - Select five (5) tabs and perform the following test. Affix five (5) tabs at 24 inch intervals on an asphaltic pavement in a straight line. Using a medium size passenger vehicle or pickup, run over the markers with the front and rear tires at a speed of 35 to 40 miles per hour, four (4) times in each direction. No more than one (1) out of the five (5) reflective surfaces shall be lost or displaced as a result of this test.
- Small design variances may be noted between tab manufacturers.
- See Standard Sheet WZ(STPM) for tab placement on new pavements. See Standard Sheet TCP(7-1) for tab placement on seal coat work.

### RAISED PAVEMENT MARKERS USED AS GUIDEMARKS

- Raised pavement markers used as guidemarks shall be from the approved product list, and meet the requirements of DMS-4200.
- All temporary construction raised pavement markers provided on a project shall be of the same manufacturer.
- Adhesive for guidemarks shall be bituminous material hot applied or butyl rubber pad for all surfaces, or thermoplastic for concrete surfaces.

Guidemarks shall be designated as:  
 YELLOW - (two amber reflective surfaces with yellow body).  
 WHITE - (one silver reflective surface with white body).

DEPARTMENTAL MATERIAL SPECIFICATIONS	
PAVEMENT MARKERS (REFLECTORIZED)	DMS-4200
TRAFFIC BUTTONS	DMS-4300
EPOXY AND ADHESIVES	DMS-6100
BITUMINOUS ADHESIVE FOR PAVEMENT MARKERS	DMS-6130
PERMANENT PREFABRICATED PAVEMENT MARKINGS	DMS-8240
TEMPORARY REMOVABLE, PREFABRICATED PAVEMENT MARKINGS	DMS-8241
TEMPORARY FLEXIBLE, REFLECTIVE ROADWAY MARKER TABS	DMS-8242

A list of prequalified reflective raised pavement markers, non-reflective traffic buttons, roadway marker tabs and other pavement markings can be found at the Material Producer List web address shown on BC(1).

SHEET 11 OF 12



## BARRICADE AND CONSTRUCTION PAVEMENT MARKINGS

**BC(11)-21**

FILE: bc-21.dgn	DN: TxDOT	CR: TxDOT	OW: TxDOT	CK: TxDOT
© TxDOT February 1998	CONT	SECT	JOB	HIGHWAY
REVISIONS	6393	46	001	IH0030
2-98 9-07 5-21	DIST	COUNTY	SHEET NO.	
1-02 7-13	18	DALLAS	19	
11-02 8-14				

DISCLAIMER: The use of this standard is governed by the "Texas Engineering Practice Act". No warranty of any kind is made by TxDOT for any purpose whatsoever. TxDOT assumes no responsibility for the conversion of this standard to other formats or for incorrect results or damages resulting from its use.

DATE: 10/14/2021 11:03:02 AM  
 FILE: T:\DALAO\DALNEAO\Maint. Contracts\2022 RMC Folder\Tree Trimming and Brush Removal\6393-46-001 East Tree Trimming & Brush Removal\Standards\bc-21.dgn

## PAVEMENT MARKING PATTERNS



REFLECTORIZED PAVEMENT MARKINGS - PATTERN A



REFLECTORIZED PAVEMENT MARKINGS - PATTERN B

Pattern A is the TXDOT Standard, however Pattern B may be used if approved by the Engineer. Prefabricated markings may be substituted for reflectORIZED pavement markings.



RAISED PAVEMENT MARKERS - PATTERN A



RAISED PAVEMENT MARKERS - PATTERN B

## CENTER LINE & NO-PASSING ZONE BARRIER LINES FOR TWO-LANE, TWO-WAY HIGHWAYS



REFLECTORIZED PAVEMENT MARKINGS

Prefabricated markings may be substituted for reflectORIZED pavement markings.

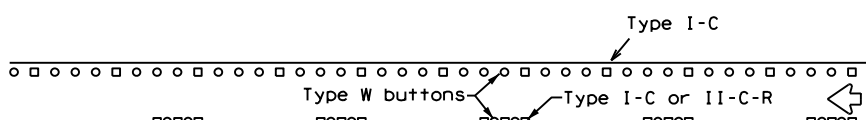

RAISED PAVEMENT MARKERS

## EDGE & LANE LINES FOR DIVIDED HIGHWAY

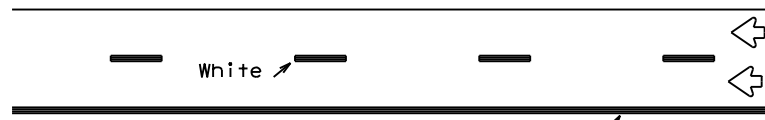

REFLECTORIZED PAVEMENT MARKINGS

Prefabricated markings may be substituted for reflectORIZED pavement markings.

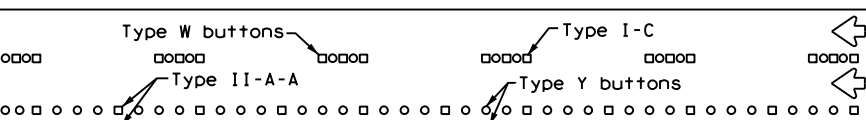

RAISED PAVEMENT MARKERS

## LANE & CENTER LINES FOR MULTILANE UNDIVIDED HIGHWAYS

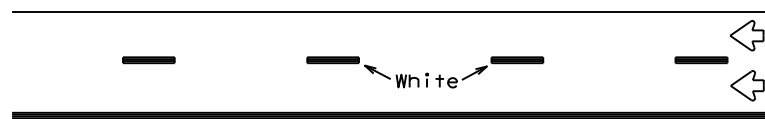

REFLECTORIZED PAVEMENT MARKINGS

Prefabricated markings may be substituted for reflectORIZED pavement markings.

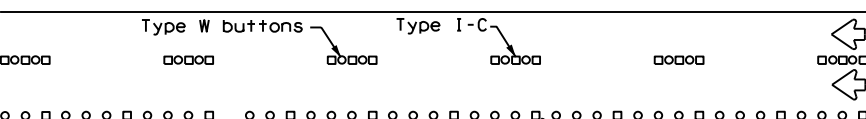

RAISED PAVEMENT MARKERS

## TWO-WAY LEFT TURN LANE

## STANDARD WORK ZONE PAVEMENT MARKINGS DETAILS

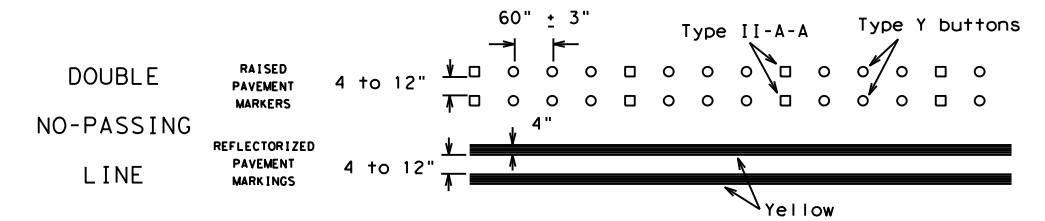

### SOLID LINES

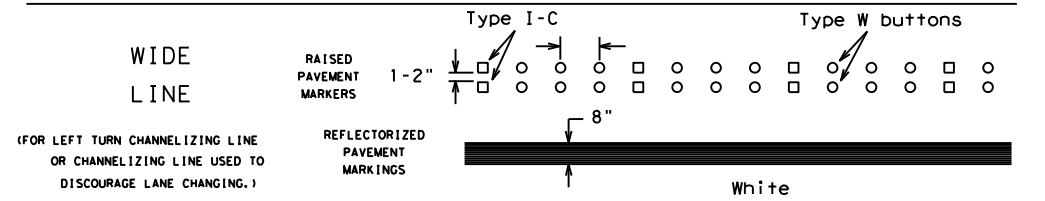
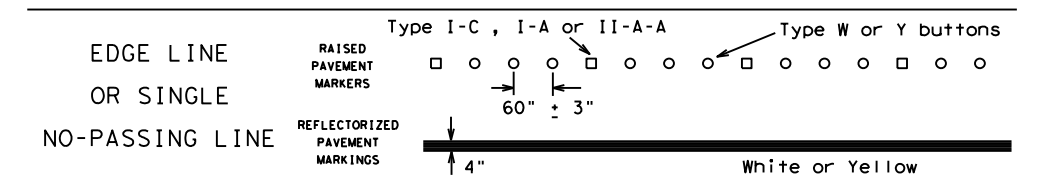

### BROKEN LINES

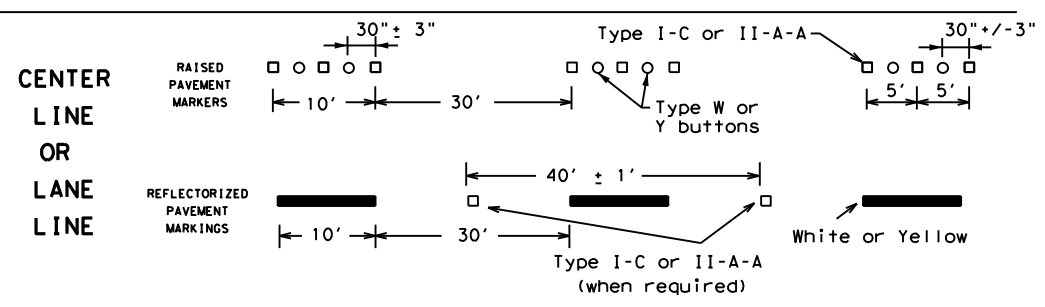

### AUXILIARY OR LANEDROP LINE

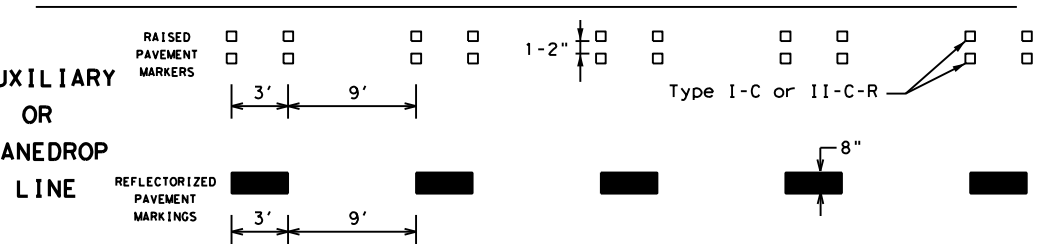

### REMOVABLE MARKINGS WITH RAISED PAVEMENT MARKERS

If raised pavement markers are used to supplement REMOVABLE markings, the markers shall be applied to the top of the tape at the approximate mid length of tape used for broken lines or at 20 foot spacing for solid lines. This allows an easier removal of raised pavement markers and tape.

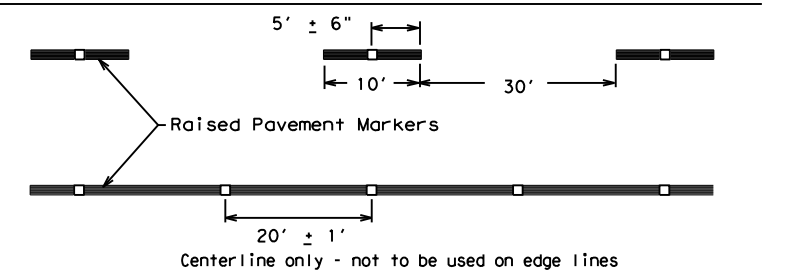

SHEET 12 OF 12



## BARRICADE AND CONSTRUCTION PAVEMENT MARKING PATTERNS

BC(12)-21

FILE: bc-21.dgn	DN: TxDOT	CK: TxDOT	OW: TxDOT	CR: TxDOT
©TxDOT February 1998	CONT	SECT	JOB	HIGHWAY
REVISIONS	6393	46	001	IH0030
1-97 9-07 5-21	DIST	COUNTY	SHEET NO.	
2-98 7-13	18	DALLAS	20	
11-02 8-14				

Raised pavement markers used as standard pavement markings shall be from the approved products list and meet the requirements of Item 672 "RAISED PAVEMENT MARKERS."

DISCLAIMER: The use of this standard is governed by the "Texas Engineering Practice Act". No warranty of any kind is made by TXDOT for any purpose whatsoever. TXDOT assumes no responsibility for the conversion of this standard to other formats or for incorrect or damages resulting from its use.

DATE: 10/14/2021 11:03:04 AM  
FILE: T:\DALAO\DALNEAO\Maint. Contracts\2022 RMC Folder\Tree Trimming and Brush Removal\6393-46-001 East Tree Trimming & Brush Removal\Standards\bc-21.dgn

DISCLAIMER: The use of this standard is governed by the "Texas Engineering Practice Act". No warranty of any kind is made by TxDOT for any purpose whatsoever. TxDOT assumes no responsibility for the conversion of units or the use of this standard in any project. The use of this standard is governed by the "Texas Engineering Practice Act". No warranty of any kind is made by TxDOT for any purpose whatsoever. TxDOT assumes no responsibility for the conversion of units or the use of this standard in any project.

Warning sign and rumble strip sequence in opposite direction is same as below

Flagger to Flagger (Length of Work Area)	ADT	# of Rumble Strip Arrays
1/8 Mile	< 4,500	1
	≥ 4,500	2
1/4 Mile	< 3,500	1
	≥ 3,500	2
1/2 Mile	< 2,600	1
	≥ 2,600	2
1 Mile	< 1,600	1
	≥ 1,600	2
> 1 Mile	N/A	2

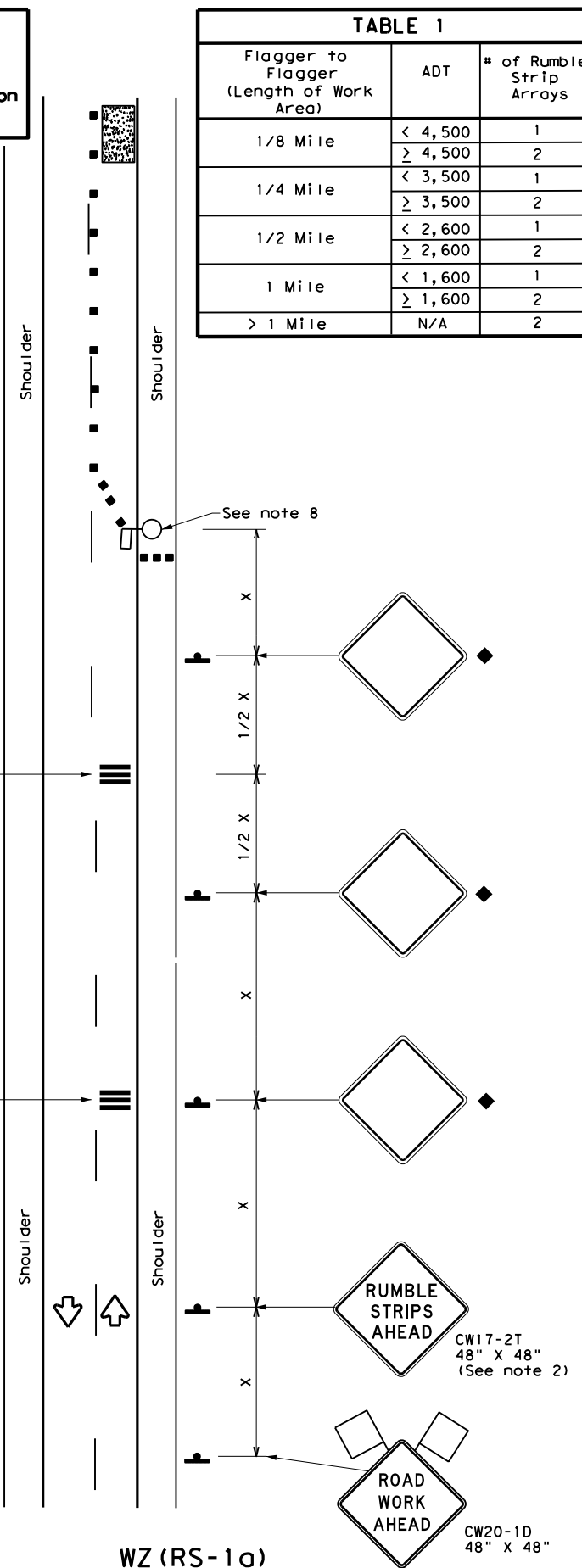

WZ (RS-1a)  
75 mph or Less  
**RUMBLE STRIPS ON ONE-LANE TWO-WAY APPLICATION**

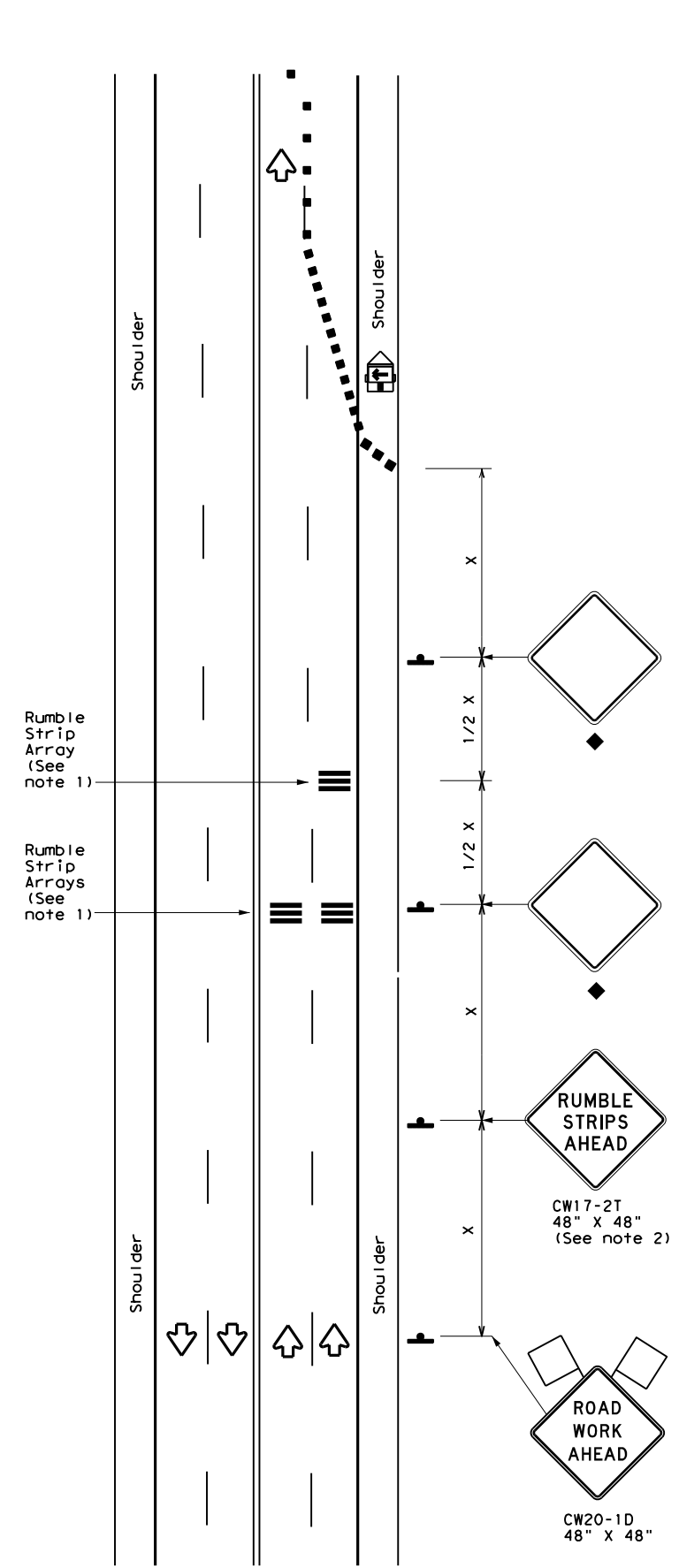

WZ (RS-1b)  
75 mph or Less  
**RUMBLE STRIPS FOR LANE CLOSURE ON CONVENTIONAL ROADWAY**

**GENERAL NOTES**

- Each Rumble Strip Array should consist of three rumble strips spaced center to center at the spacing shown in Table 2, placed transverse across the lane at locations shown.
- The CW17-2T "RUMBLE STRIPS AHEAD" sign should be located after the CW20-1D "ROAD WORK AHEAD" sign and spaced as shown. If traffic is observed to be queuing, or is expected to queue beyond the Rumble Strips, the CW17-2T sign and the first Rumble Strip Array may be located upstream of the CW20-1D sign as necessary to provide needed warning.
- Temporary Rumble Strips will be considered subsidiary to Item 502, and shall be a product listed on the Compliant Work Zone Traffic Control Devices.
- Removal of the Temporary Rumble Strips should be accomplished before removing the advance warning signs.
- Temporary Rumble Strips should not be used on horizontal curves, loose gravel, soft or bleeding asphalt, heavily rutted pavements or unpaved surfaces.
- Temporary Rumble Strips shall be installed and maintained as per manufacturer's recommendations.
- This standard sheet shall be used in conjunction with other appropriate TCP standard, TMUTCD typical application or project specific detail for the project.
- The one-lane two-way application may utilize a flagger, an AFAD or a portable traffic signal.
- Temporary Rumble Strips may be used on freeways or expressways based on engineering judgment.

Speed	Approximate distance between strips in an Array
≤ 40 MPH	10'
> 40 MPH & ≤ 55 MPH	15'
> 55 MPH	20'

	Type 3 Barricade		Channelizing Devices
	Heavy Work Vehicle		Truck Mounted Attenuator (TMA)
	Trailer Mounted Flashing Arrow Panel		Portable Changeable Message Sign (PCMS)
	Sign		Traffic Flow
	Flag		Flagger

Posted Speed *	Formula	Minimum Desirable Taper Lengths **			Suggested Maximum Spacing of Channelizing Devices		Minimum Sign Spacing "x" Distance	Suggested Longitudinal Buffer Space "B"
		10' Offset	11' Offset	12' Offset	On a Taper	On a Tangent		
30	L = WS <sup>2</sup> / 60	150'	165'	180'	30'	60'	120'	90'
35		205'	225'	245'	35'	70'	160'	120'
40		265'	295'	320'	40'	80'	240'	155'
45	L = WS	450'	495'	540'	45'	90'	320'	195'
50		500'	550'	600'	50'	100'	400'	240'
55		550'	605'	660'	55'	110'	500'	295'
60		600'	660'	720'	60'	120'	600'	350'
65		650'	715'	780'	65'	130'	700'	410'
70	700'	770'	840'	70'	140'	800'	475'	
75	750'	825'	900'	75'	150'	900'	540'	

\* Conventional Roads Only  
 \*\* Taper lengths have been rounded off.  
 L=Length of Taper (FT) W=Width of Offset (FT)  
 S=Posted Speed (MPH)

MOBILE	SHORT DURATION	SHORT TERM STATIONARY	INTERMEDIATE TERM STATIONARY	LONG TERM STATIONARY
	✓	✓		

◆ Signs are for illustrative purposes only. Signs required may vary depending on the TCP, TMUTCD Typical Application, or project specific details for the project.

Texas Department of Transportation  
 Traffic Operations Division Standard

## TEMPORARY RUMBLE STRIPS

### WZ (RS) - 16

FILE: wzrs16.dgn	DN: TxDOT	CK: TxDOT	DW: TxDOT	CK: TxDOT
© TxDOT November 2012	CONT	SECT	JOB	HIGHWAY
REVISIONS	6393	46	001	IHO030
2-14	DIST	COUNTY	SHEET NO.	
4-16	18	DALLAS	21	

DISCLAIMER: The use of this standard is governed by the "Texas Engineering Practice Act". No warranty of any kind is made by TxDOT for any purpose whatsoever. TxDOT assumes no responsibility for the conversion of units or the use of this standard in any other manner. This standard is not intended to be used for any purpose other than that for which it was developed. The use of this standard is governed by the "Texas Engineering Practice Act". No warranty of any kind is made by TxDOT for any purpose whatsoever. TxDOT assumes no responsibility for the conversion of units or the use of this standard in any other manner. This standard is not intended to be used for any purpose other than that for which it was developed.

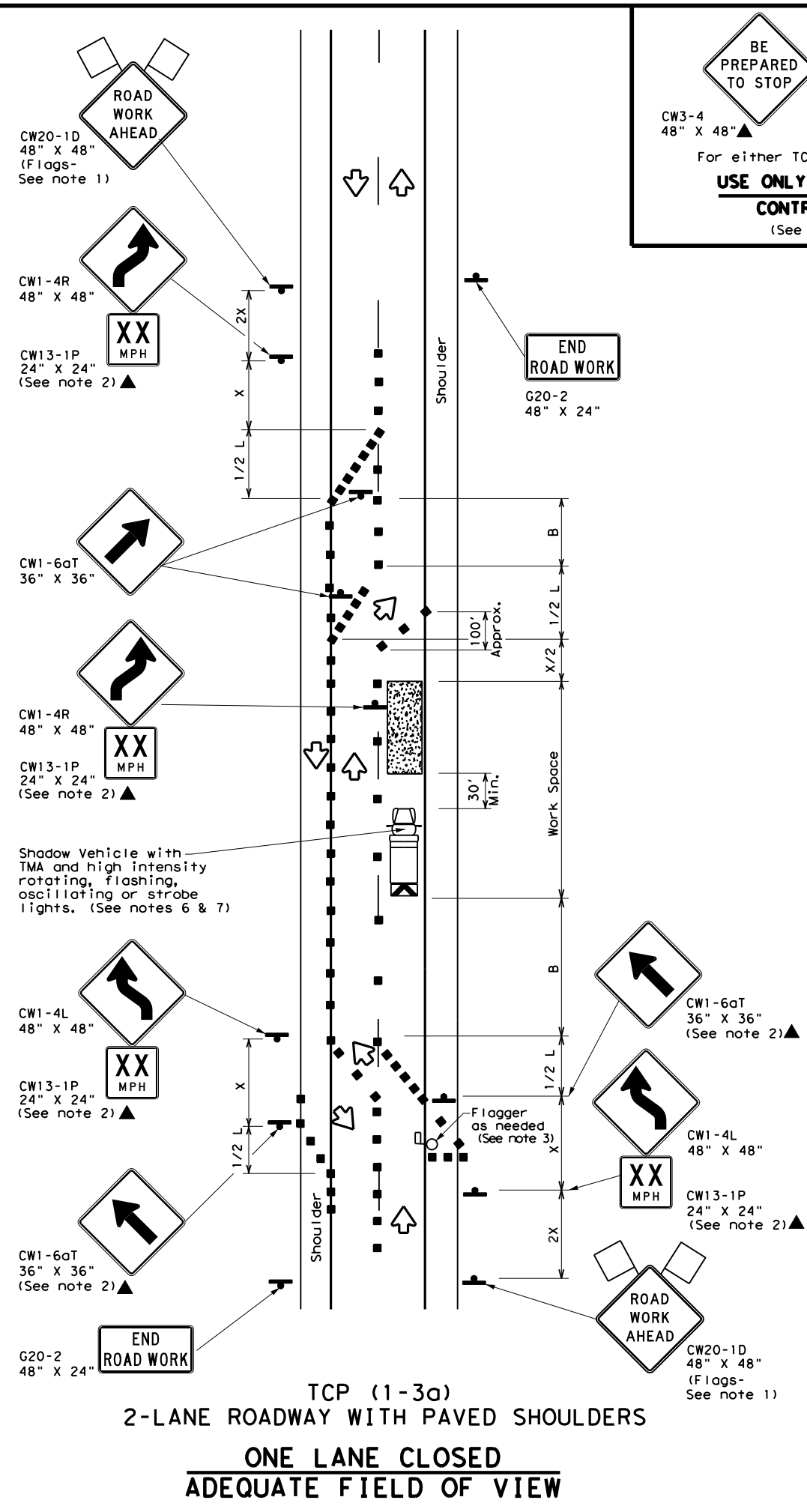

BE PREPARED TO STOP  
USE ONLY WHEN FLAGGERS CONTROL TRAFFIC  
(See Notes 2 & 3)

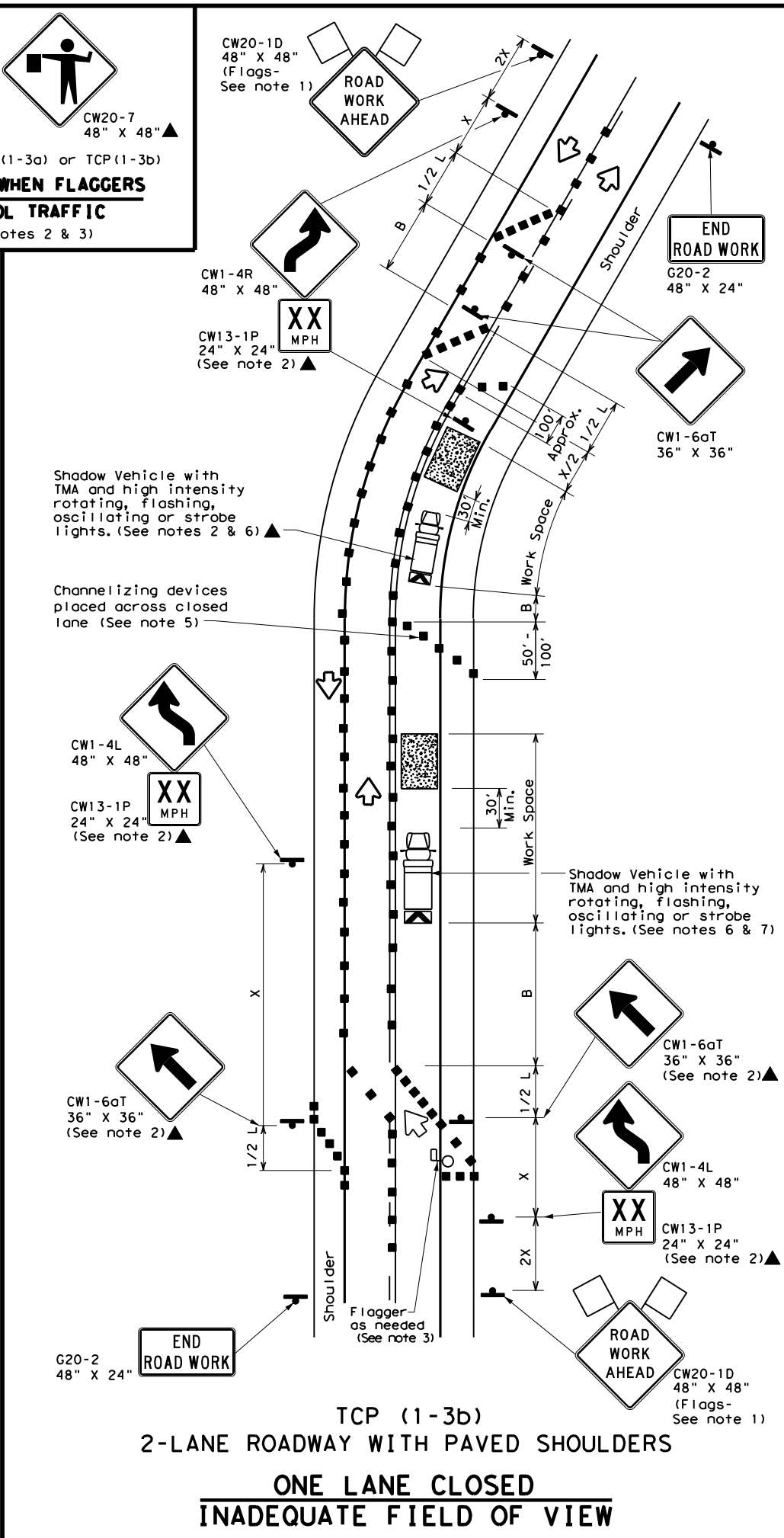

LEGEND			
	Type 3 Barricade		Channelizing Devices
	Heavy Work Vehicle		Truck Mounted Attenuator (TMA)
	Trailer Mounted Flashing Arrow Board		Portable Changeable Message Sign (PCMS)
	Sign		Traffic Flow
	Flag		Flagger

Posted Speed *	Formula	Minimum Desirable Taper Lengths **			Suggested Maximum Spacing of Channelizing Devices		Minimum Sign Spacing "X" Distance	Suggested Longitudinal Buffer Space "B"
		10' Offset	11' Offset	12' Offset	On a Taper	On a Tangent		
30	L = WS / 60	150'	165'	180'	30'	60'	120'	90'
35		205'	225'	245'	35'	70'	160'	120'
40		265'	295'	320'	40'	80'	240'	155'
45	L = WS	450'	495'	540'	45'	90'	320'	195'
50		500'	550'	600'	50'	100'	400'	240'
55		550'	605'	660'	55'	110'	500'	295'
60		600'	660'	720'	60'	120'	600'	350'
65		650'	715'	780'	65'	130'	700'	410'
70		700'	770'	840'	70'	140'	800'	475'
75		750'	825'	900'	75'	150'	900'	540'

\* Conventional Roads Only  
\*\* Taper lengths have been rounded off.  
L=Length of Taper (FT) W=Width of Offset (FT) S=Posted Speed (MPH)

TYPICAL USAGE				
MOBILE	SHORT DURATION	SHORT TERM STATIONARY	INTERMEDIATE TERM STATIONARY	LONG TERM STATIONARY
	✓	✓		

- GENERAL NOTES**
- Flags attached to signs where shown are REQUIRED.
  - All traffic control devices illustrated are REQUIRED, except those denoted with the triangle symbol may be omitted when stated elsewhere in the plans, or for routine maintenance work, when approved by the Engineer.
  - Flagger control should NOT be used unless roadway conditions or heavy traffic volume require additional emphasis to safely control traffic. Additional flaggers may be positioned in advance of traffic queues to alert traffic to reduce speed.
  - DO NOT PASS, PASS WITH CARE and construction regulatory speed zone signs may be installed downstream of the ROAD WORK AHEAD signs.
  - When the work zone is made up of several work spaces, channelizing devices should be placed laterally across the closed lane to re-emphasize closure. Laterally placed channelizing devices should be repeated every 500 to 1000 feet in urban areas and every 1/4 to 1/2 mile in rural areas.
  - A Shadow Vehicle with a TMA should be used anytime it can be positioned 30 to 100 feet in advance of the area of crew exposure without adversely affecting the performance or quality of the work. If workers are no longer present but road or work conditions require the traffic control to remain in place, Type 3 Barricades or other channelizing devices may be substituted for the Shadow Vehicle and TMA.
  - Additional Shadow Vehicles with TMAs may be positioned off the paved surface, next to those shown in order to protect wider work spaces.
  - Where traffic is directed over a yellow centerline, channelizing devices which separate two-way traffic should be spaced on tapers at 20', or 15' if posted speed are 35 mph or slower, and for tangent sections, at 1/2S where S is the speed in mph. This tighter device spacing is intended for the area of conflicting markings not the entire work zone.

Texas Department of Transportation  
Traffic Operations Division Standard

**TRAFFIC CONTROL PLAN**  
**TRAFFIC SHIFTS ON**  
**TWO LANE ROADS**  
**TCP (1-3) - 18**

FILE: tcp1-3-18.dgn	DN:	CK:	DW:	CK:
© TxDOT December 1985	CONT	SECT	JOB	HIGHWAY
REVISIONS	6393	46	001	IHO030
2-94 4-98				
8-95 2-12	DIST	COUNTY		SHEET NO.
1-97 2-18	18	DALLAS		22

DISCLAIMER: The use of this standard is governed by the "Texas Engineering Practice Act". No warranty of any kind is made by TxDOT for any purpose whatsoever. TxDOT assumes no responsibility for the conversion of units or the use of this standard in any other state or country.

DATE: 10/14/2021 11:03:13 AM  
 FILE: T:\DALAO\DALNEAO\Maint. Contracts\2022 RMC Folder\Tree Trimming and Brush Removal\2022 RMC Folder\1-18.dgn

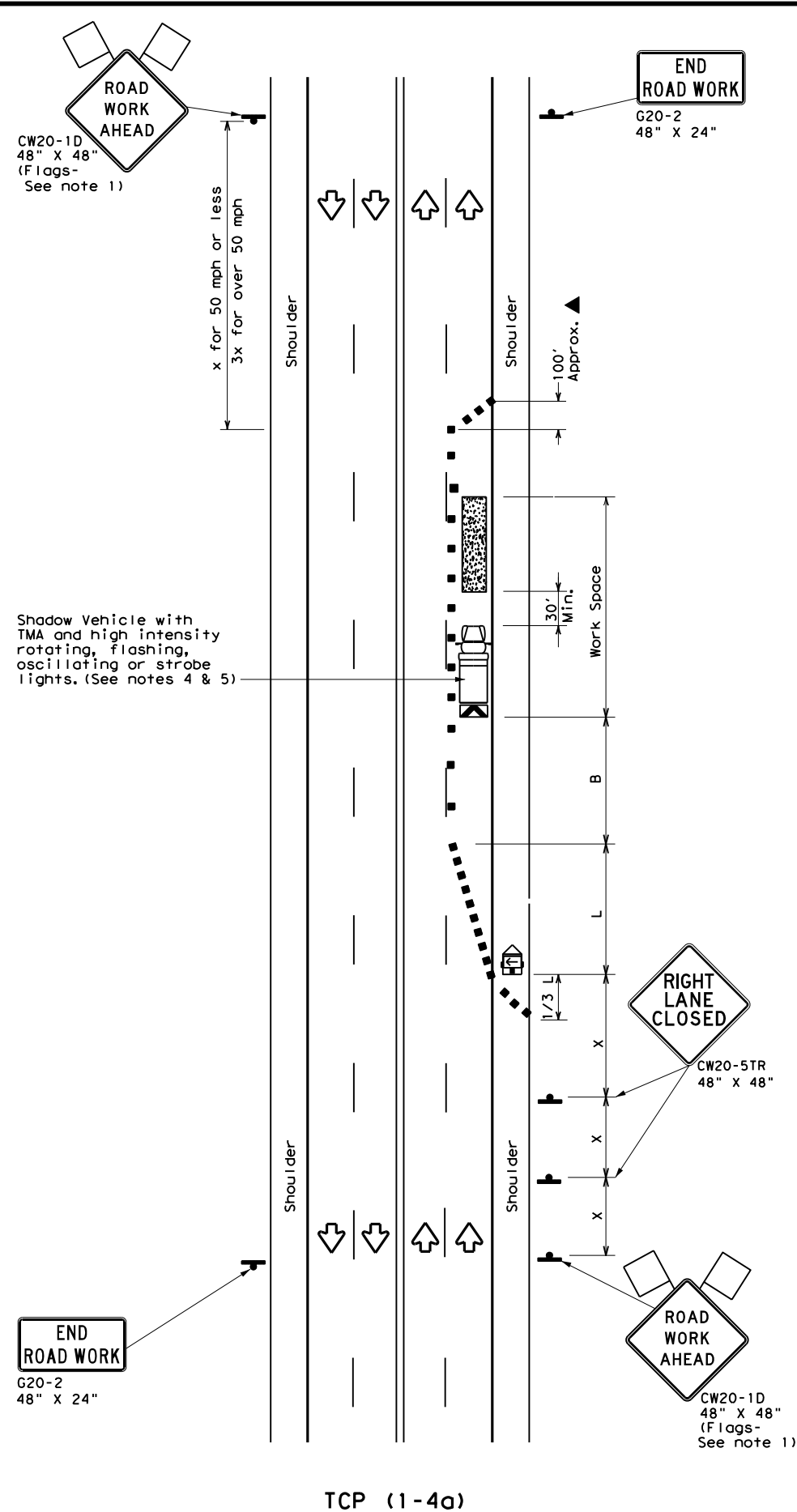

TCP (1-4a)  
**ONE LANE CLOSED**

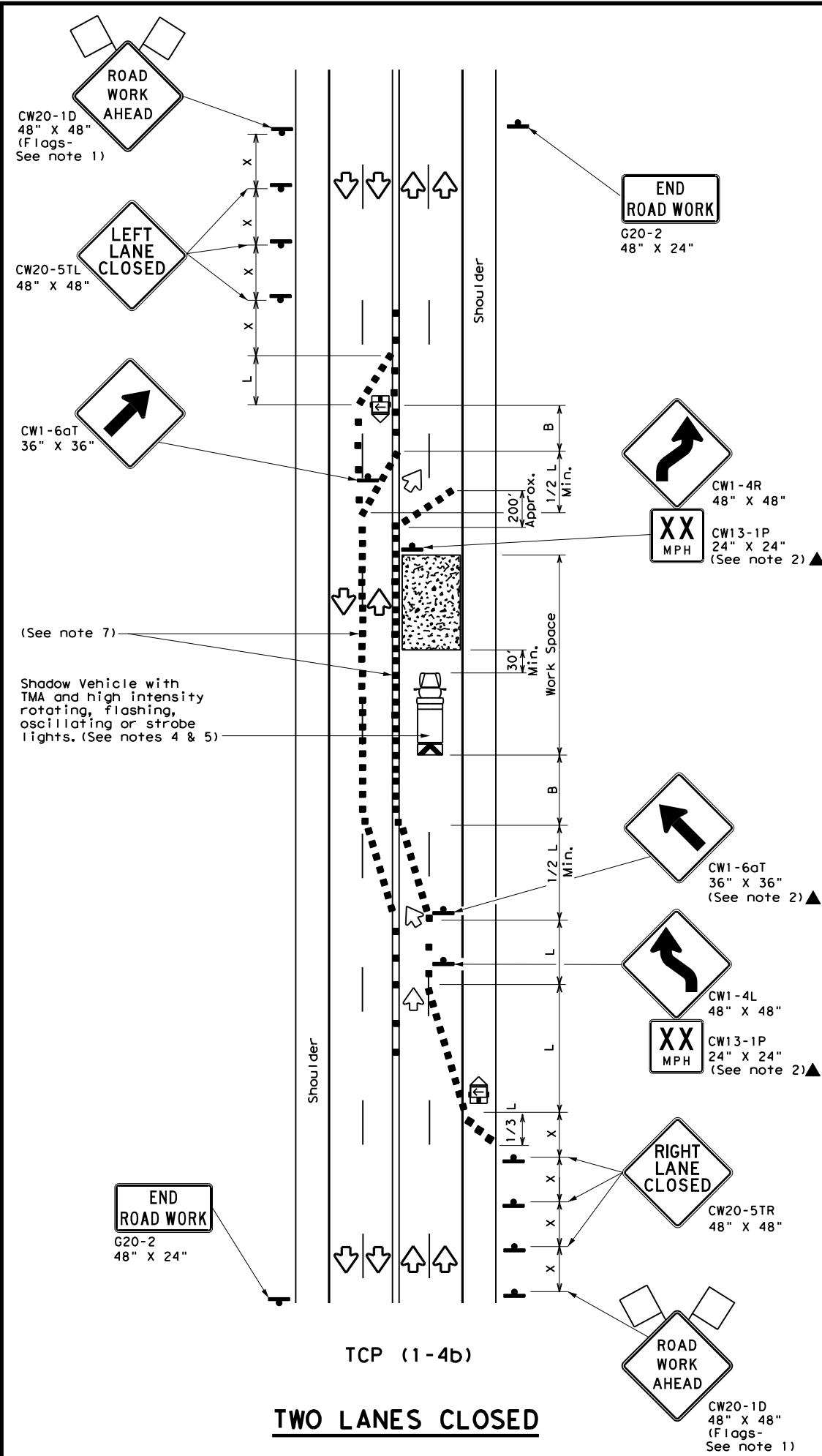

TCP (1-4b)  
**TWO LANES CLOSED**

LEGEND			
	Type 3 Barricade		Channelizing Devices
	Heavy Work Vehicle		Truck Mounted Attenuator (TMA)
	Trailer Mounted Flashing Arrow Board		Portable Changeable Message Sign (PCMS)
	Sign		Traffic Flow
	Flag		Flagger

Posted Speed *	Formula	Minimum Desirable Taper Lengths **			Suggested Maximum Spacing of Channelizing Devices		Minimum Sign Spacing "X" Distance	Suggested Longitudinal Buffer Space "B"
		10' Offset	11' Offset	12' Offset	On a Taper	On a Tangent		
30	$L = \frac{WS^2}{60}$	150'	165'	180'	30'	60'	120'	90'
35		205'	225'	245'	35'	70'	160'	120'
40		265'	295'	320'	40'	80'	240'	155'
45	L = WS	450'	495'	540'	45'	90'	320'	195'
50		500'	550'	600'	50'	100'	400'	240'
55		550'	605'	660'	55'	110'	500'	295'
60		600'	660'	720'	60'	120'	600'	350'
65		650'	715'	780'	65'	130'	700'	410'
70		700'	770'	840'	70'	140'	800'	475'
75		750'	825'	900'	75'	150'	900'	540'

\* Conventional Roads Only  
 \*\* Taper lengths have been rounded off.  
 L=Length of Taper (FT) W=Width of Offset (FT) S=Posted Speed (MPH)

TYPICAL USAGE				
MOBILE	SHORT DURATION	SHORT TERM STATIONARY	INTERMEDIATE TERM STATIONARY	LONG TERM STATIONARY
	✓	✓		

- GENERAL NOTES**
- Flags attached to signs where shown are REQUIRED.
  - All traffic control devices illustrated are REQUIRED, except those denoted with the triangle symbol may be omitted when stated elsewhere in the plans, or for routine maintenance work, when approved by the Engineer.
  - The CW20-1D "ROAD WORK AHEAD" sign may be repeated if the visibility of the work zone is less than 1500 feet.
  - A Shadow Vehicle with a TMA should be used anytime it can be positioned 30 to 100 feet in advance of the area of crew exposure without adversely affecting the performance or quality of the work. If workers are no longer present but road or work conditions require the traffic control to remain in place, Type 3 Barricades or other channelizing devices may be substituted for the Shadow Vehicle and TMA.
  - Additional Shadow Vehicles with TMAs may be positioned off the paved surface, next to those shown in order to protect wider work spaces.

**TCP (1-4a)**

- If this TCP is used for a left lane closure, CW20-5TL "LEFT LANE CLOSED" signs shall be used and channelizing devices shall be placed on the centerline where needed to protect the work space from opposing traffic with the arrow panel placed in the closed lane near the end of the merging taper.

**TCP (1-4b)**

- Where traffic is directed over a yellow centerline, channelizing devices which separate two-way traffic should be spaced on tapers at 20' or 15' if posted speeds are 35 mph or slower, and for tangent sections, at 1/2S where S is the speed in mph. This tighter device spacing is intended for the areas of conflicting markings, not the entire work zone.

		Traffic Operations Division Standard	
<b>TRAFFIC CONTROL PLAN          LANE CLOSURES ON MULTILANE          CONVENTIONAL ROADS</b>			
<b>TCP (1-4) - 18</b>			
FILE:	tcp1-4-18.dgn	DN:	CK:
© TxDOT	December 1985	CONT	SECT
REVISIONS		6393	46
2-94	4-98	JOB	HIGHWAY
8-95	2-12	001	IH0030
1-97	2-18	DIST	COUNTY
		18	DALLAS
			SHEET NO.
			23

DISCLAIMER: The use of this standard is governed by the "Texas Engineering Practice Act". No warranty of any kind is made by TxDOT for any purpose whatsoever. TxDOT assumes no responsibility for the conversion of units or the accuracy of any information or results derived therefrom.

DATE: 10/14/2021 11:03:16 AM  
 FILE: T:\DALAO\DALNEAO\Maint. Contracts\2022 RMC Folder\Tree Trimming and Brush Removal\6393-46\6393-46.dgn

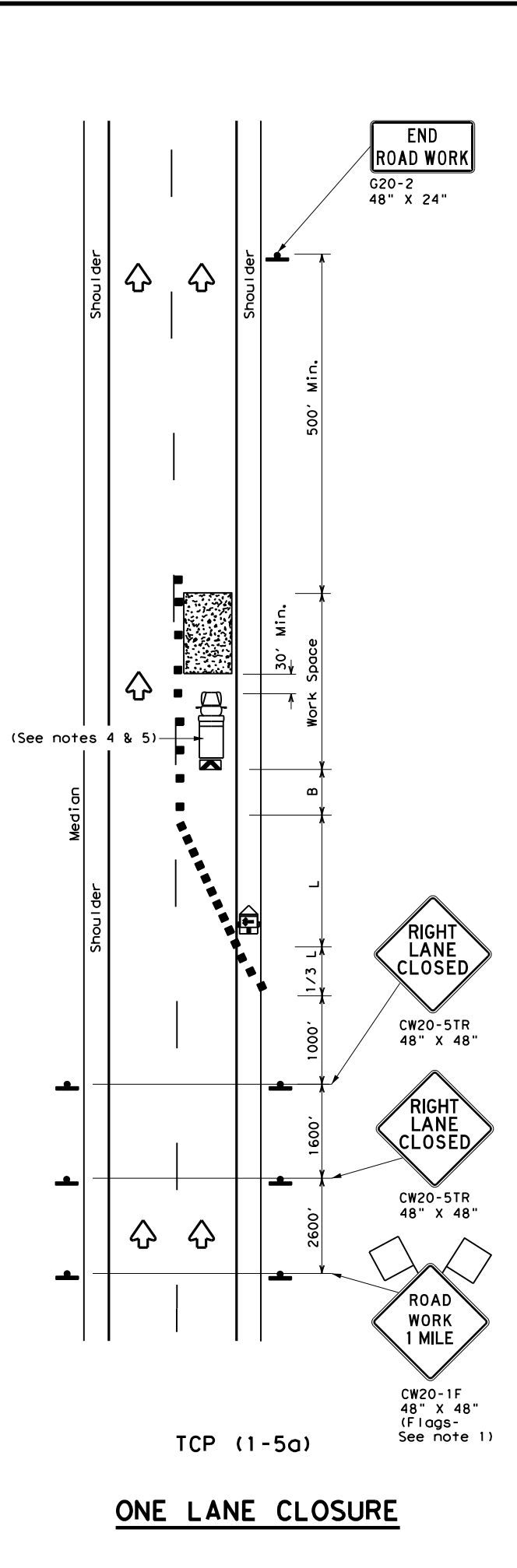

**ONE LANE CLOSURE**

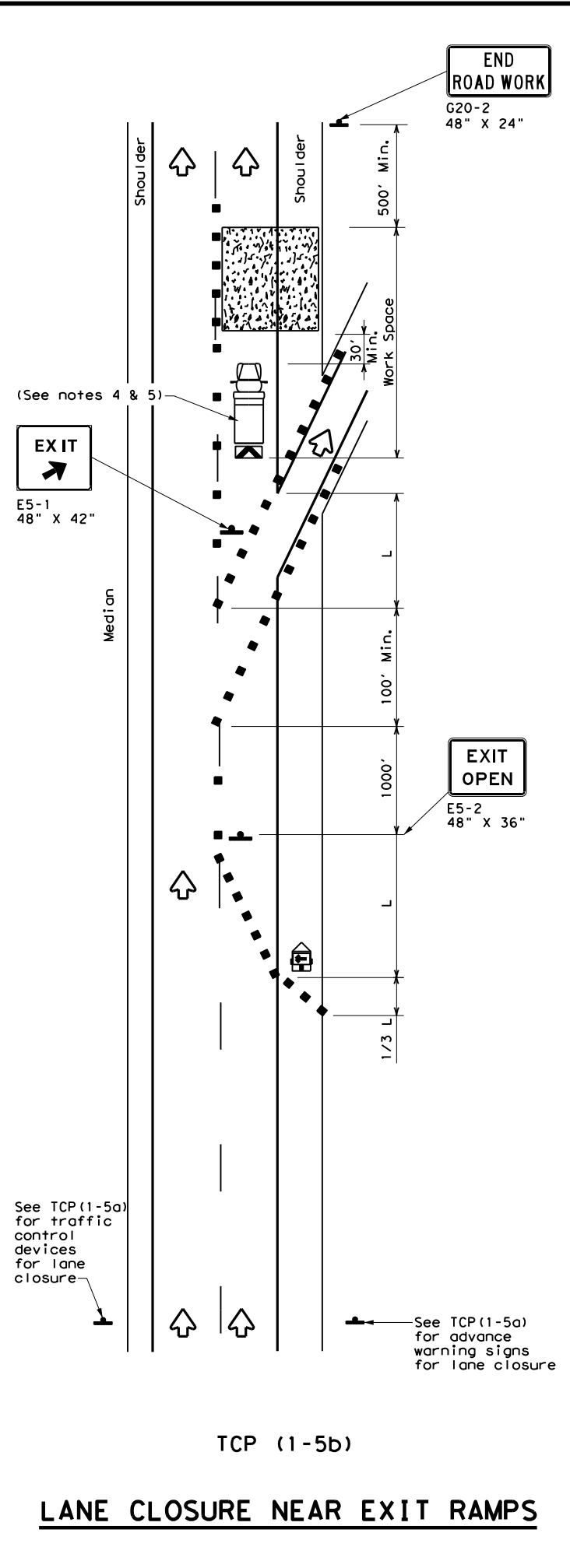

**LANE CLOSURE NEAR EXIT RAMP**

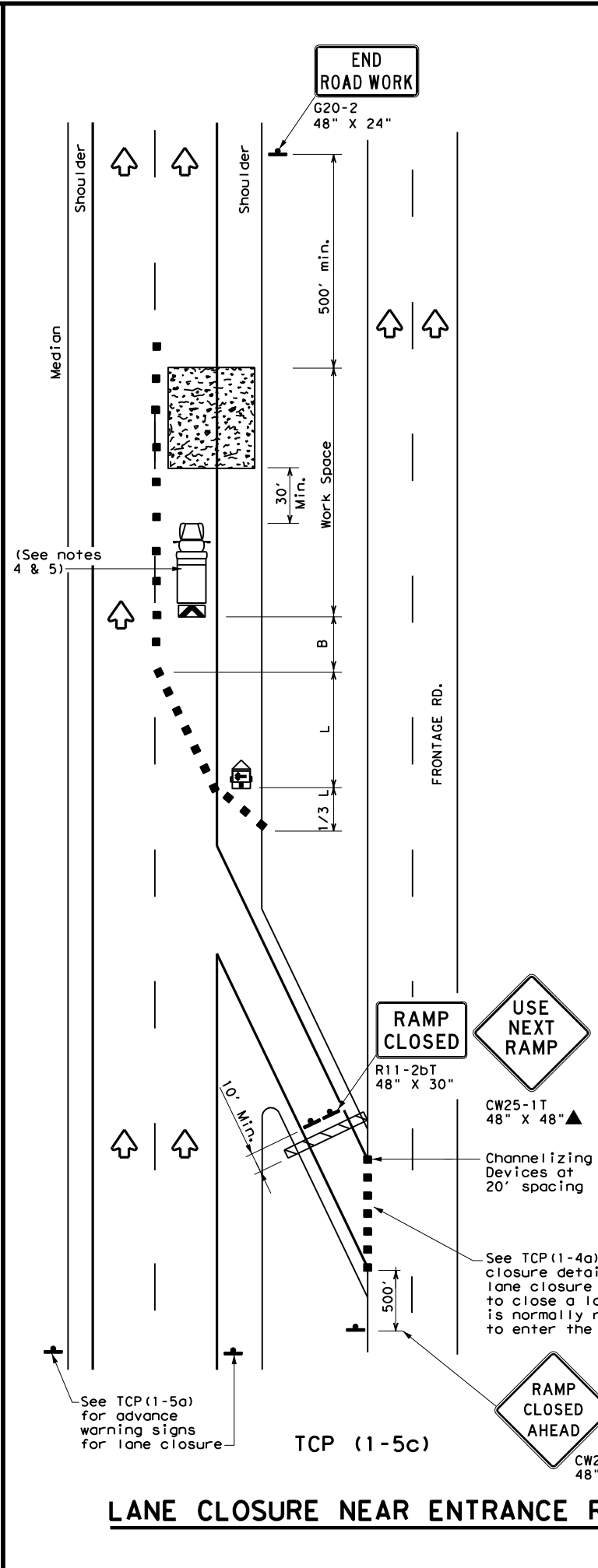

**LANE CLOSURE NEAR ENTRANCE RAMP**

LEGEND			
	Type 3 Barricade		Channelizing Devices
	Heavy Work Vehicle		Truck Mounted Attenuator (TMA)
	Trailer Mounted Flashing Arrow Board		Portable Changeable Message Sign (PCMS)
	Sign		Traffic Flow
	Flag		Flagger

Posted Speed *	Formula	Minimum Desirable Taper Lengths **			Suggested Maximum Spacing of Channelizing Devices		Minimum Sign Spacing "X" Distance	Suggested Longitudinal Buffer Space "B"
		10' Offset	11' Offset	12' Offset	On a Taper	On a Tangent		
30	$L = \frac{WS^2}{60}$	150'	165'	180'	30'	60'	120'	90'
35		205'	225'	245'	35'	70'	160'	120'
40		265'	295'	320'	40'	80'	240'	155'
45	L = WS	450'	495'	540'	45'	90'	320'	195'
50		500'	550'	600'	50'	100'	400'	240'
55		550'	605'	660'	55'	110'	500'	295'
60		600'	660'	720'	60'	120'	600'	350'
65		650'	715'	780'	65'	130'	700'	410'
70		700'	770'	840'	70'	140'	800'	475'
75		750'	825'	900'	75'	150'	900'	540'

\* Conventional Roads Only  
 \*\* Taper lengths have been rounded off.  
 L=Length of Taper (FT) W=Width of Offset (FT) S=Posted Speed (MPH)

TYPICAL USAGE				
MOBILE	SHORT DURATION	SHORT TERM STATIONARY	INTERMEDIATE TERM STATIONARY	LONG TERM STATIONARY
		✓		

- GENERAL NOTES**
- Flags attached to signs where shown, are REQUIRED.
  - All traffic control devices illustrated are REQUIRED, except those denoted with the triangle symbol may be omitted when stated elsewhere in the plans, or for routine maintenance work, when approved by the Engineer.
  - Channelizing devices used to close lanes may be supplemented with the Chevron Alignment Sign placed on every other channelizing device. Chevrons may be attached to plastic drums as per BC Standards.
  - Shadow Vehicle with TMA and high intensity rotating, flashing, oscillating or strobe lights. A Shadow Vehicle with a TMA should be used anytime it can be positioned 30 to 100 feet in advance of the area of crew exposure without adversely affecting the performance or quality of the work. If workers are no longer present but road or work conditions require the traffic control to remain in place, Type 3 Barricades or other channelizing devices may be substituted for the Shadow Vehicle and TMA.
  - Additional Shadow Vehicles with TMAs may be positioned in each closed lane, on the shoulder or off the paved surface, next to those shown in order to protect a wider work space.

**Traffic Operations Division Standard**

**TRAFFIC CONTROL PLAN**  
**LANE CLOSURES FOR**  
**DIVIDED HIGHWAYS**

**TCP (1-5) - 18**

FILE: tcp1-5-18.dgn	DN:	CK:	DW:	CK:
© TxDOT February 2012	CONT	SECT	JOB	HIGHWAY
2-18	6393	46	001	IH0030
REVISIONS	DIST	COUNTY	SHEET NO.	
	18	DALLAS	24	



DISCLAIMER: The use of this standard is governed by the "Texas Engineering Practice Act". No warranty of any kind is made by TxDOT for any purpose whatsoever. TxDOT assumes no responsibility for the conversion of units or the use of this standard in any manner other than that intended by the original author.

DATE: 10/14/2021 11:03:18 AM  
 FILE: T:\DALAO\DALNEAO\Maint. Contracts\2022 RMC Folder\Tree Trimming and Brush Removal\6393.dgn

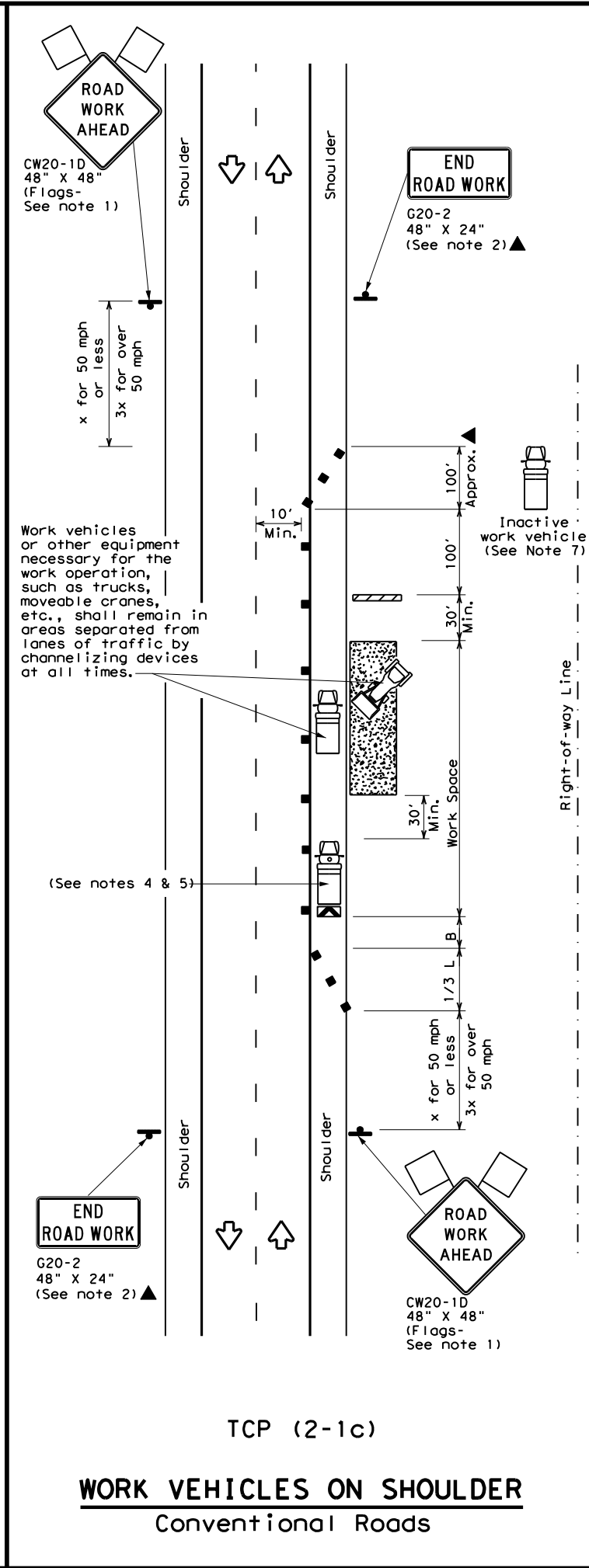
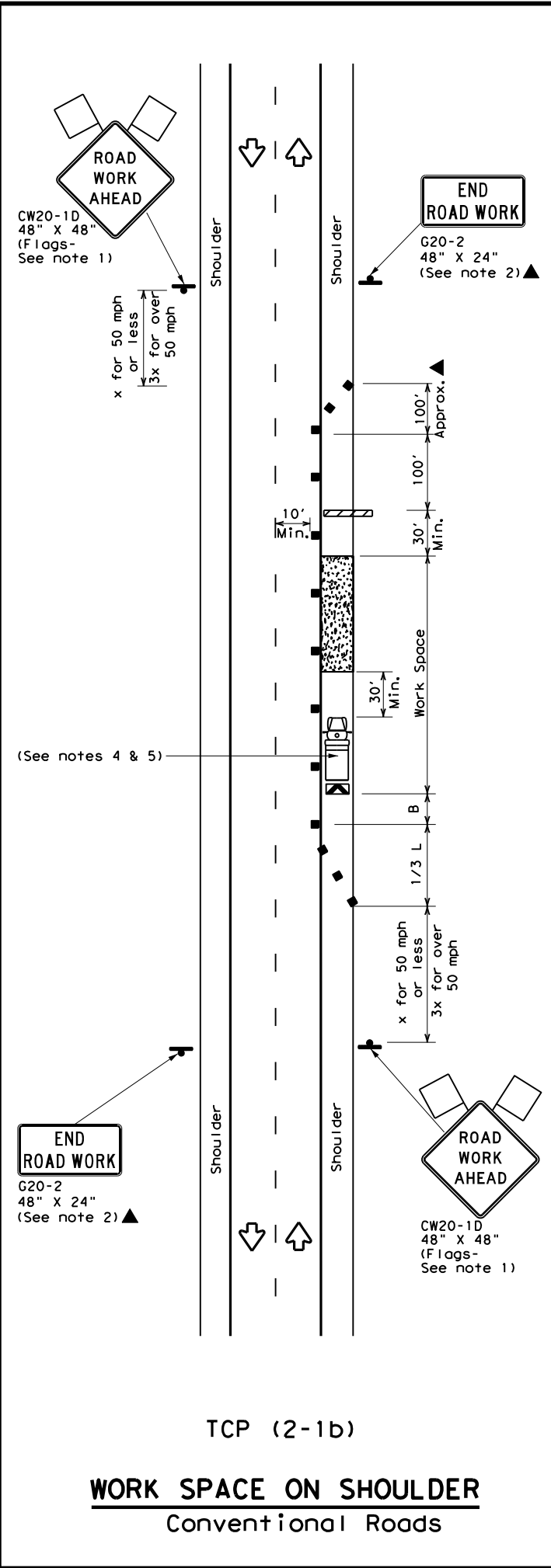
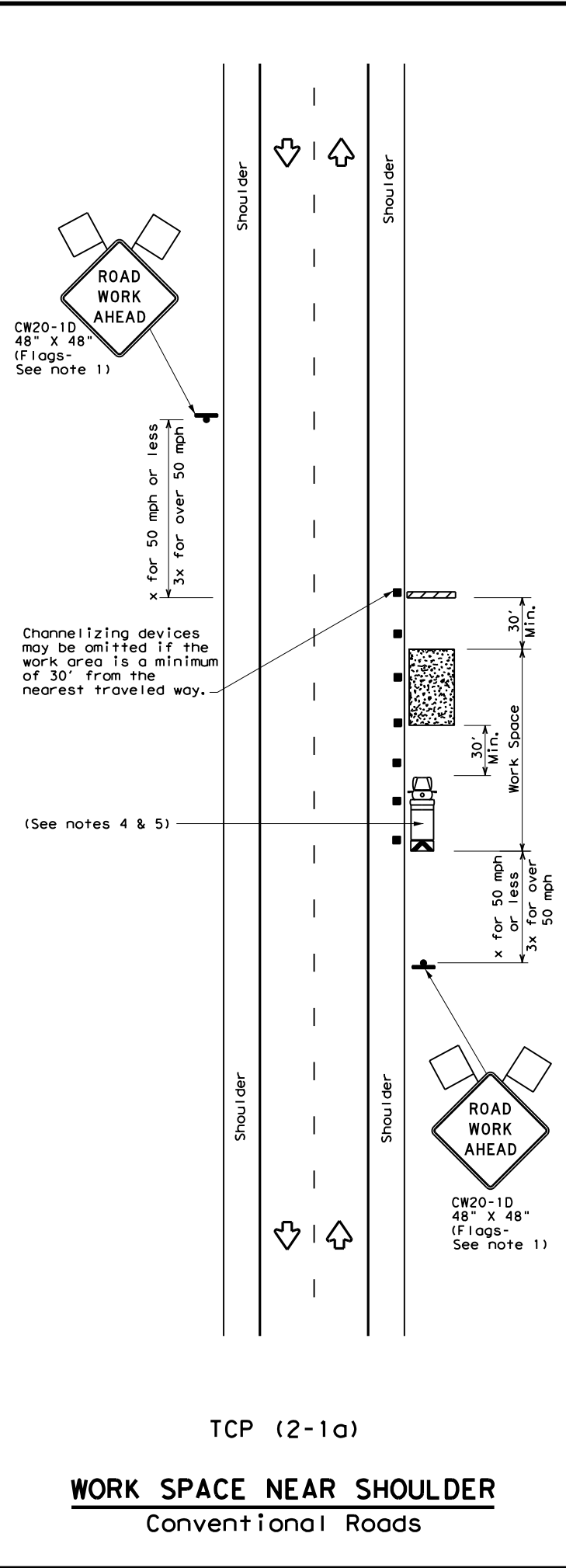

LEGEND			
	Type 3 Barricade		Channelizing Devices
	Heavy Work Vehicle		Truck Mounted Attenuator (TMA)
	Trailer Mounted Flashing Arrow Board		Portable Changeable Message Sign (PCMS)
	Sign		Traffic Flow
	Flag		Flagger

Posted Speed *	Formula	Minimum Desirable Taper Lengths **			Suggested Maximum Spacing of Channelizing Devices		Minimum Sign Spacing "X" Distance	Suggested Longitudinal Buffer Space "B"
		10' Offset	11' Offset	12' Offset	On a Taper	On a Tangent		
30	$L = \frac{WS^2}{60}$	150'	165'	180'	30'	60'	120'	90'
35		205'	225'	245'	35'	70'	160'	120'
40		265'	295'	320'	40'	80'	240'	155'
45	L = WS	450'	495'	540'	45'	90'	320'	195'
50		500'	550'	600'	50'	100'	400'	240'
55		550'	605'	660'	55'	110'	500'	295'
60		600'	660'	720'	60'	120'	600'	350'
65		650'	715'	780'	65'	130'	700'	410'
70		700'	770'	840'	70'	140'	800'	475'
75		750'	825'	900'	75'	150'	900'	540'

\* Conventional Roads Only  
 \*\* Taper lengths have been rounded off.  
 L=Length of Taper (FT) W=Width of Offset (FT) S=Posted Speed (MPH)

TYPICAL USAGE				
MOBILE	SHORT DURATION	SHORT TERM STATIONARY	INTERMEDIATE TERM STATIONARY	LONG TERM STATIONARY
	✓	✓	✓	✓

- GENERAL NOTES**
- Flags attached to signs where shown, are REQUIRED.
  - All traffic control devices illustrated are REQUIRED, except those denoted with the triangle symbol may be omitted when stated in the plans, or for routine maintenance work, when approved by the Engineer.
  - Stockpiled material should be placed a minimum of 30 feet from nearest traveled way.
  - Shadow Vehicle with TMA and high intensity rotating, flashing, oscillating or strobe lights. A Shadow Vehicle with a TMA should be used anytime it can be positioned 30 to 100 feet in advance of the area of crew exposure without adversely affecting the performance or quality of the work. If workers are no longer present but road or work conditions require the traffic control to remain in place, Type 3 Barricades or other channelizing devices may be substituted for the Shadow Vehicle and TMA.
  - Additional Shadow Vehicles with TMAs may be positioned off the paved surface, next to those shown in order to protect a wider work space.
  - See TCP(5-1) for shoulder work on divided highways, expressways and freeways.
  - Additional work vehicles or other equipment should be parked near the right-of-way line and not parked on the paved shoulder.
  - CW21-5 "SHOULDER WORK" signs may be used in place of CW20-1D "ROAD WORK AHEAD" signs for shoulder work on conventional roadways.

Texas Department of Transportation  
 Traffic Operations Division Standard

**TRAFFIC CONTROL PLAN**  
**CONVENTIONAL ROAD**  
**SHOULDER WORK**

**TCP (2-1) - 18**

FILE: tcp2-1-18.dgn	DN:	CK:	DW:	CK:
© TxDOT December 1985	CONT	SECT	JOB	HIGHWAY
REVISIONS	6393	46	001	IH0030
2-94 4-98	DIST	COUNTY	SHEET NO.	
8-95 2-12	18	DALLAS	25	
1-97 2-18				

DISCLAIMER: The use of this standard is governed by the "Texas Engineering Practice Act". No warranty of any kind is made by TxDOT for any purpose whatsoever. TxDOT assumes no responsibility for the conversion of units or the use of this standard in any other manner. This standard is not intended to be used for any purpose other than that for which it was developed. The use of this standard is governed by the "Texas Engineering Practice Act". No warranty of any kind is made by TxDOT for any purpose whatsoever. TxDOT assumes no responsibility for the conversion of units or the use of this standard in any other manner. This standard is not intended to be used for any purpose other than that for which it was developed.

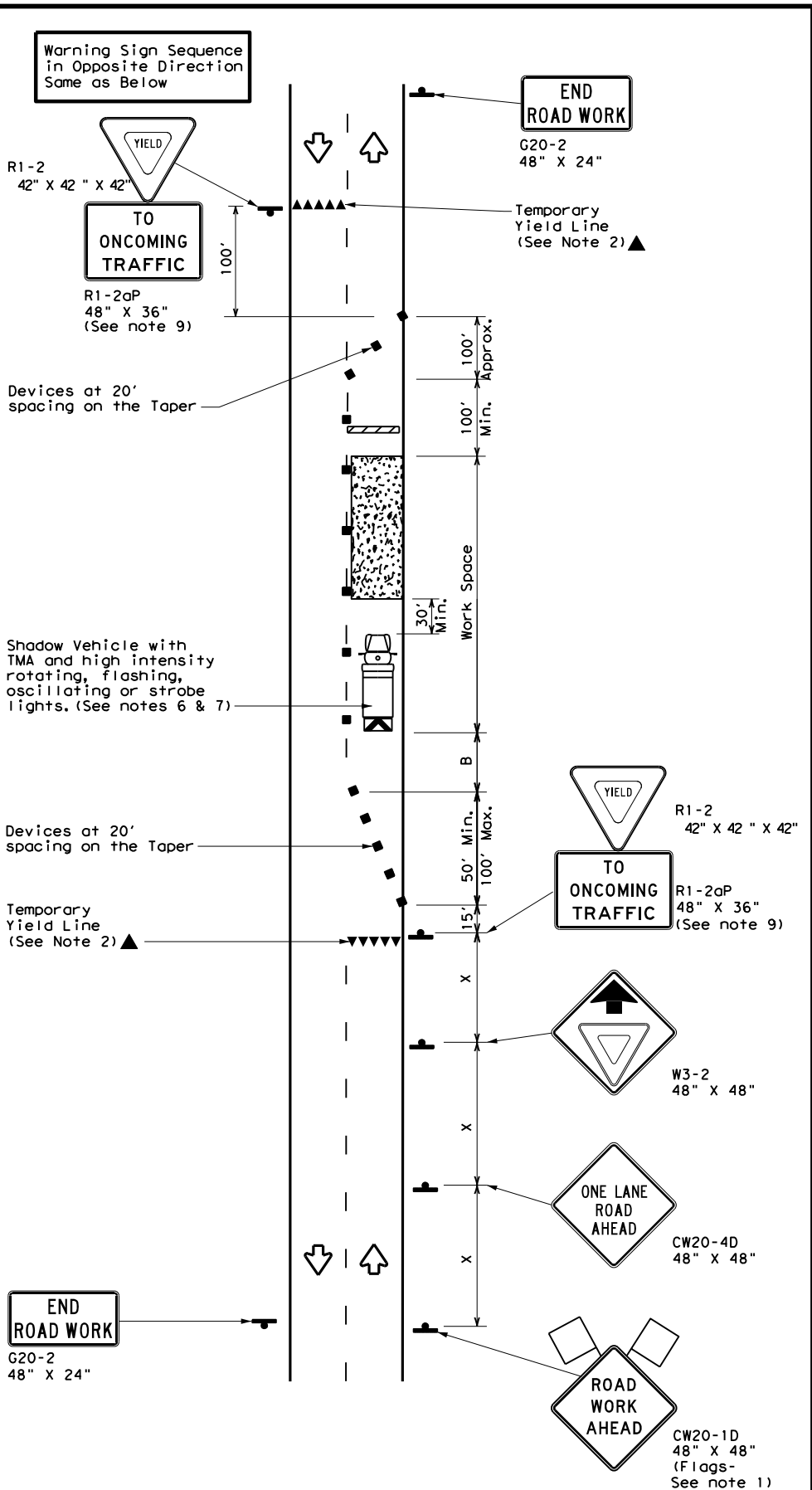

TCP (2-2a)  
2-LANE ROADWAY WITHOUT PAVED SHOULDERS  
ONE LANE TWO-WAY  
CONTROL WITH YIELD SIGNS  
(Less than 2000 ADT - See Note 9)

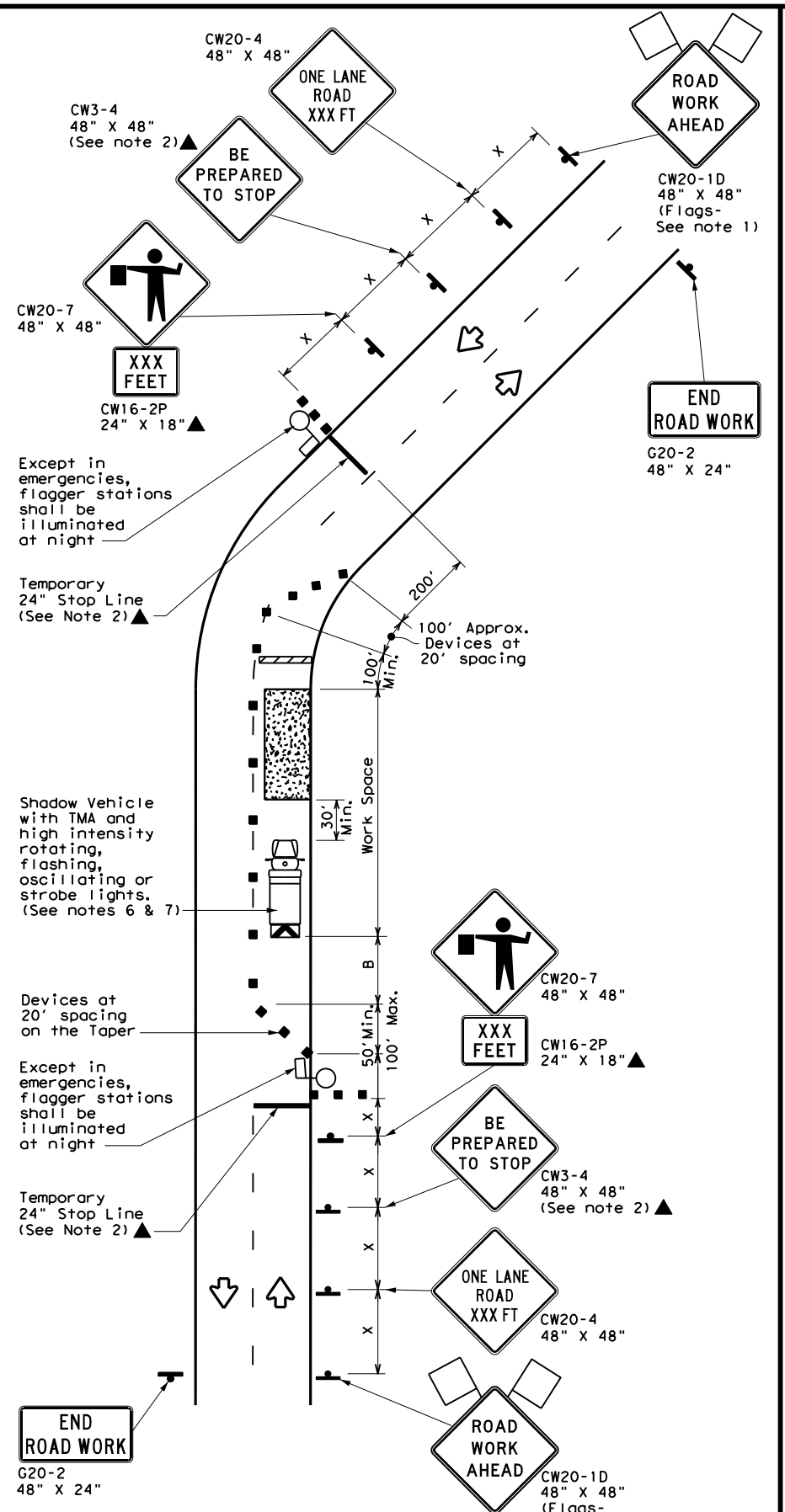

TCP (2-2b)  
2-LANE ROADWAY WITHOUT PAVED SHOULDERS  
ONE LANE TWO-WAY  
CONTROL WITH FLAGGERS

**LEGEND**

	Type 3 Barricade		Channelizing Devices
	Heavy Work Vehicle		Truck Mounted Attenuator (TMA)
	Trailer Mounted Flashing Arrow Board		Portable Changeable Message Sign (PCMS)
	Sign		Traffic Flow
	Flag		Flagger

Posted Speed *	Formula	Minimum Desirable Taper Lengths **			Suggested Maximum Spacing of Channelizing Devices		Minimum Sign Spacing "X" Distance	Suggested Longitudinal Buffer Space "B"	Stopping Sight Distance
		10' Offset	11' Offset	12' Offset	On a Taper	On a Tangent			
30	L = WS <sup>2</sup> / 60	150'	165'	180'	30'	60'	120'	90'	200'
35		205'	225'	245'	35'	70'	160'	120'	250'
40		265'	295'	320'	40'	80'	240'	155'	305'
45	L = WS	450'	495'	540'	45'	90'	320'	195'	360'
50		500'	550'	600'	50'	100'	400'	240'	425'
55		550'	605'	660'	55'	110'	500'	295'	495'
60		600'	660'	720'	60'	120'	600'	350'	570'
65		650'	715'	780'	65'	130'	700'	410'	645'
70		700'	770'	840'	70'	140'	800'	475'	730'
75		750'	825'	900'	75'	150'	900'	540'	820'

\* Conventional Roads Only  
 \*\* Taper lengths have been rounded off.  
 L=Length of Taper (FT) W=Width of Offset (FT) S=Posted Speed (MPH)

**TYPICAL USAGE**

MOBILE	SHORT DURATION	SHORT TERM STATIONARY	INTERMEDIATE TERM STATIONARY	LONG TERM STATIONARY
	✓	✓	✓	

**GENERAL NOTES**

- Flags attached to signs where shown, are REQUIRED.
  - All traffic control devices illustrated are REQUIRED, except those denoted with the triangle symbol may be omitted when stated elsewhere in the plans, or for routine maintenance work, when approved by the Engineer.
  - The CW3-4 "BE PREPARED TO STOP" sign may be installed after the CW20-4 "ONE LANE ROAD XXX FT" sign, but proper sign spacing shall be maintained.
  - Flaggers should use two-way radios or other methods of communication to control traffic.
  - Length of work space should be based on the ability of flaggers to communicate.
  - A Shadow Vehicle with a TMA should be used anytime it can be positioned 30 to 100 feet in advance of the area of crew exposure without adversely affecting the performance or quality of the work. If workers are no longer present but road or work conditions require the traffic control to remain in place, Type 3 Barricades or other channelizing devices may be substituted for the Shadow Vehicle and TMA.
  - Additional Shadow Vehicles with TMAs may be positioned off the paved surface, next to those shown in order to protect a wider work space.
- TCP (2-2a)**
- The R1-2 "YIELD" sign traffic control may be used on projects with approaches that have adequate sight distance. For projects in urban areas, work space should be no longer than one half city block. In rural areas, roadways with less than 2000 ADT, work space should be no longer than 400 feet.
  - The R1-2aP "YIELD TO ONCOMING TRAFFIC" sign shall be placed on a support at a 7 foot minimum mounting height.
- TCP (2-2b)**
- Channelizing devices on the center line may be omitted when a pilot car is leading traffic and approved by the Engineer.
  - If the work space is located near a horizontal or vertical curve, the buffer distances should be increased in order to maintain stopping sight distance to the flagger and a queue of stopped vehicles. (See table above).
  - Flaggers should use 24" STOP/SLOW paddles to control traffic. Flags should be limited to emergency situations.

Texas Department of Transportation  
 Traffic Operations Division Standard

**TRAFFIC CONTROL PLAN  
 ONE-LANE TWO-WAY  
 TRAFFIC CONTROL**

**TCP (2-2) - 18**

FILE: tcp2-2-18.dgn	DN:	CK:	DW:	CK:
© TxDOT	REVISIONS	CON	SECT	JOB
8-95 3-03		6393	46	001
1-97 2-12		DIST	COUNTY	SHEET NO.
4-98 2-18		18	DALLAS	26

DISCLAIMER: The use of this standard is governed by the "Texas Engineering Practice Act". No warranty of any kind is made by TxDOT for any purpose whatsoever. TxDOT assumes no responsibility for the conversion of units or the use of this standard in any other manner. The use of this standard is governed by the "Texas Engineering Practice Act". No warranty of any kind is made by TxDOT for any purpose whatsoever. TxDOT assumes no responsibility for the conversion of units or the use of this standard in any other manner.

DATE: 10/14/2021 11:03:23 AM  
 FILE: T:\DALA\DALNEAO\Maint. Contracts\2022 RMC Folder\Tree Trimming and Brush Removal\6393-01\6393-01-18.dgn

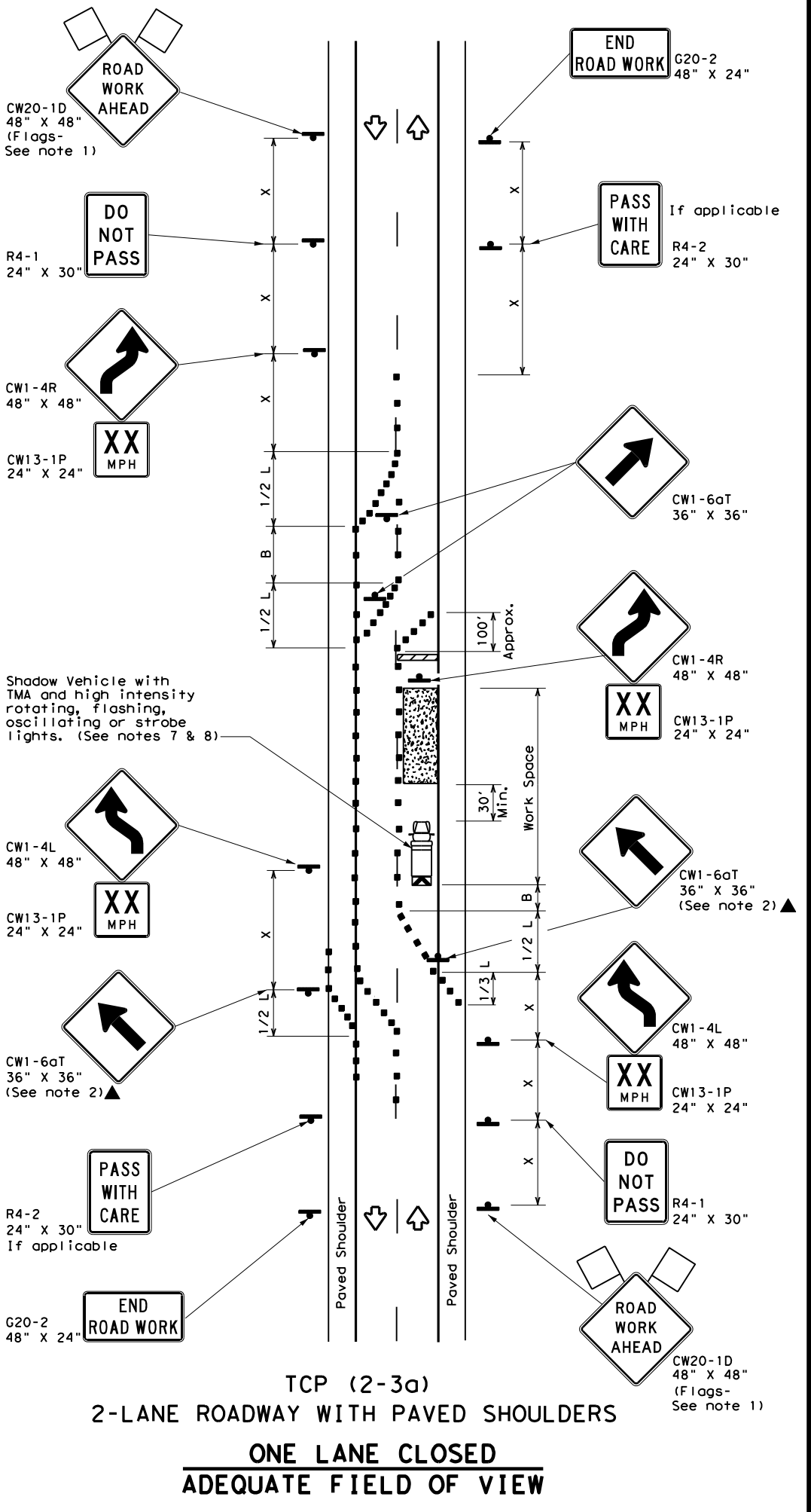

TCP (2-3a)  
 2-LANE ROADWAY WITH PAVED SHOULDERS  
 ONE LANE CLOSED  
 ADEQUATE FIELD OF VIEW

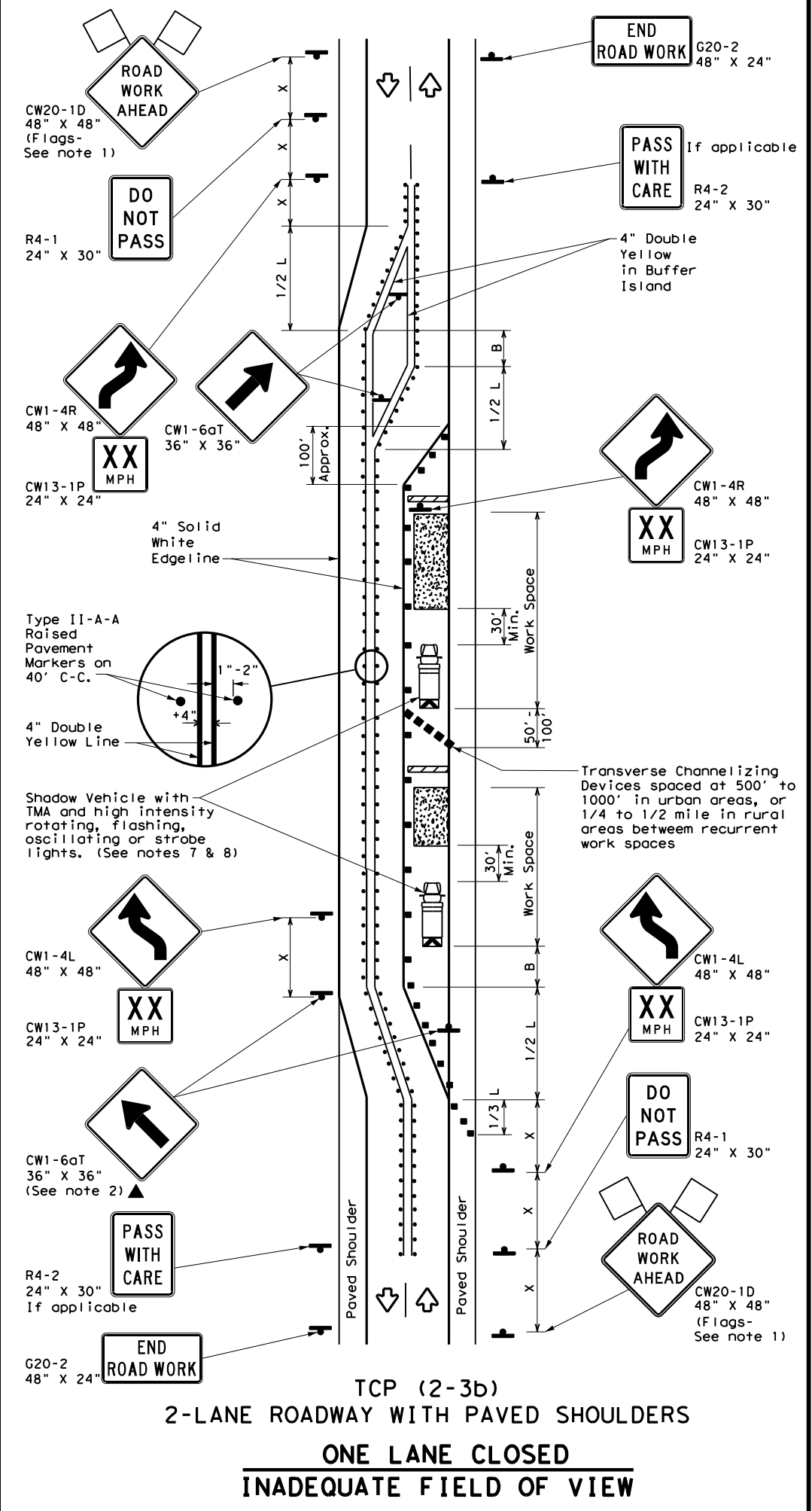

TCP (2-3b)  
 2-LANE ROADWAY WITH PAVED SHOULDERS  
 ONE LANE CLOSED  
 INADEQUATE FIELD OF VIEW

LEGEND			
	Type 3 Barricade		Channelizing Devices
	Heavy Work Vehicle		Truck Mounted Attenuator (TMA)
	Trailer Mounted Flashing Arrow Board		Raised Pavement Markers Ty II-AA
	Sign		Traffic Flow
	Flag		Flagger

Posted Speed * S	Formula L = WS <sup>2</sup> / 60	Minimum Desirable Taper Lengths **			Suggested Maximum Spacing of Channelizing Devices		Minimum Sign Spacing "x" Distance	Suggested Longitudinal Buffer Space "B"
		10' Offset	11' Offset	12' Offset	On a Taper	On a Tangent		
30	L = WS <sup>2</sup> / 60	150'	165'	180'	30'	70'	120'	90'
35		205'	225'	245'	35'	60'	160'	120'
40		265'	295'	320'	40'	80'	240'	155'
45	L = WS	450'	495'	540'	45'	90'	320'	195'
50		500'	550'	600'	50'	100'	400'	240'
55		550'	605'	660'	55'	110'	500'	295'
60	L = WS	600'	660'	720'	60'	120'	600'	350'
65		650'	715'	780'	65'	130'	700'	410'
70		700'	770'	840'	70'	140'	800'	475'
75	L = WS	750'	825'	900'	75'	150'	900'	540'
80		800'	880'	960'	80'	160'	1000'	610'
85		850'	935'	1020'	85'	170'	1100'	685'

\* Conventional Roads Only  
 \*\* Taper lengths have been rounded off.  
 L=Length of Taper (FT) W=Width of Offset (FT) S=Posted Speed (MPH)

TYPICAL USAGE				
MOBILE	SHORT DURATION	SHORT TERM STATIONARY	INTERMEDIATE TERM STATIONARY	LONG TERM STATIONARY
			✓	✓
				TCP (2-3b) ONLY

GENERAL NOTES

- Flags attached to signs where shown, are REQUIRED.
- All traffic control devices illustrated are REQUIRED, except those denoted with the triangle symbol may be omitted when stated elsewhere in the plans, or for routine maintenance work, when approved by the Engineer.
- When work space will be in place less than three days existing pavement markings may remain in place. Channelizing devices shall be used to separate traffic.
- Flagger control should NOT be used unless roadway conditions or heavy traffic volume require additional emphasis to safely control traffic. Flagger should be positioned at end of traffic queue.
- The R4-1 "DO NOT PASS," R4-2 "PASS WITH CARE" and construction regulatory speed zone signs may be installed within CW20-1D "ROAD WORK AHEAD" signs. Proper spacing of signs shall be maintained.
- Conflicting pavement marking shall be removed for long term projects.
- A Shadow Vehicle with a TMA should be used anytime it can be positioned 30 to 100 feet in advance of the area of crew exposure without adversely affecting the performance or quality of the work. If workers are no longer present but road or work conditions require the traffic control to remain in place, Type 3 Barricades or other channelizing devices may be substituted.
- Additional Shadow Vehicles with TMAs may be positioned off the paved surface, next to those shown in order to protect a wider work space.

TCP (2-3a)

Texas Department of Transportation		Traffic Operations Division Standard	
<b>TRAFFIC CONTROL PLAN          TRAFFIC SHIFTS ON          TWO-LANE ROADS</b>			
<b>TCP (2-3) - 18</b>			
FILE:	tcp(2-3)-18.dgn	DWG:	CK:
© TxDOT	December 1985	CONT. SECT.	JOB HIGHWAY
REVISIONS		6393 46	001 IH0030
8-95 3-03		DIST	COUNTY SHEET NO.
1-97 2-12		18	DALLAS 27
4-98 2-18			

DISCLAIMER: The use of this standard is governed by the "Texas Engineering Practice Act". No warranty of any kind is made by TxDOT for any purpose whatsoever. TxDOT assumes no responsibility for the conversion of units or the use of this standard in any other manner. This standard is intended for use by TxDOT and its contractors.

DATE: 10/14/2021 11:03:26 AM  
 FILE: T:\DALAO\DALNEAO\Maint. Contracts\2022 RMC Folder\Tree Trimming and Brush Removal\6393 46\6393 46.dgn

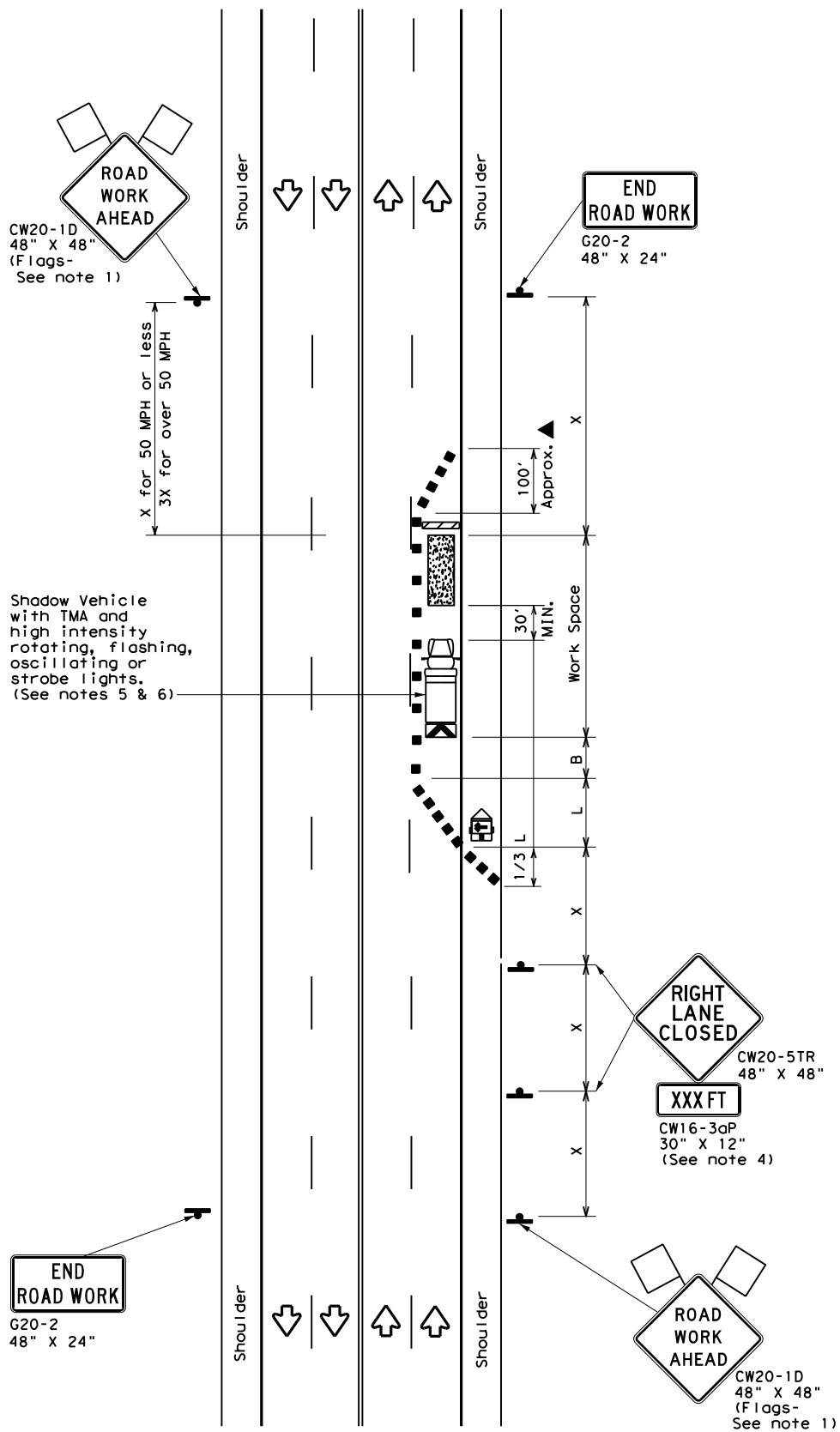

TCP (2-4a)  
**ONE LANE CLOSED**

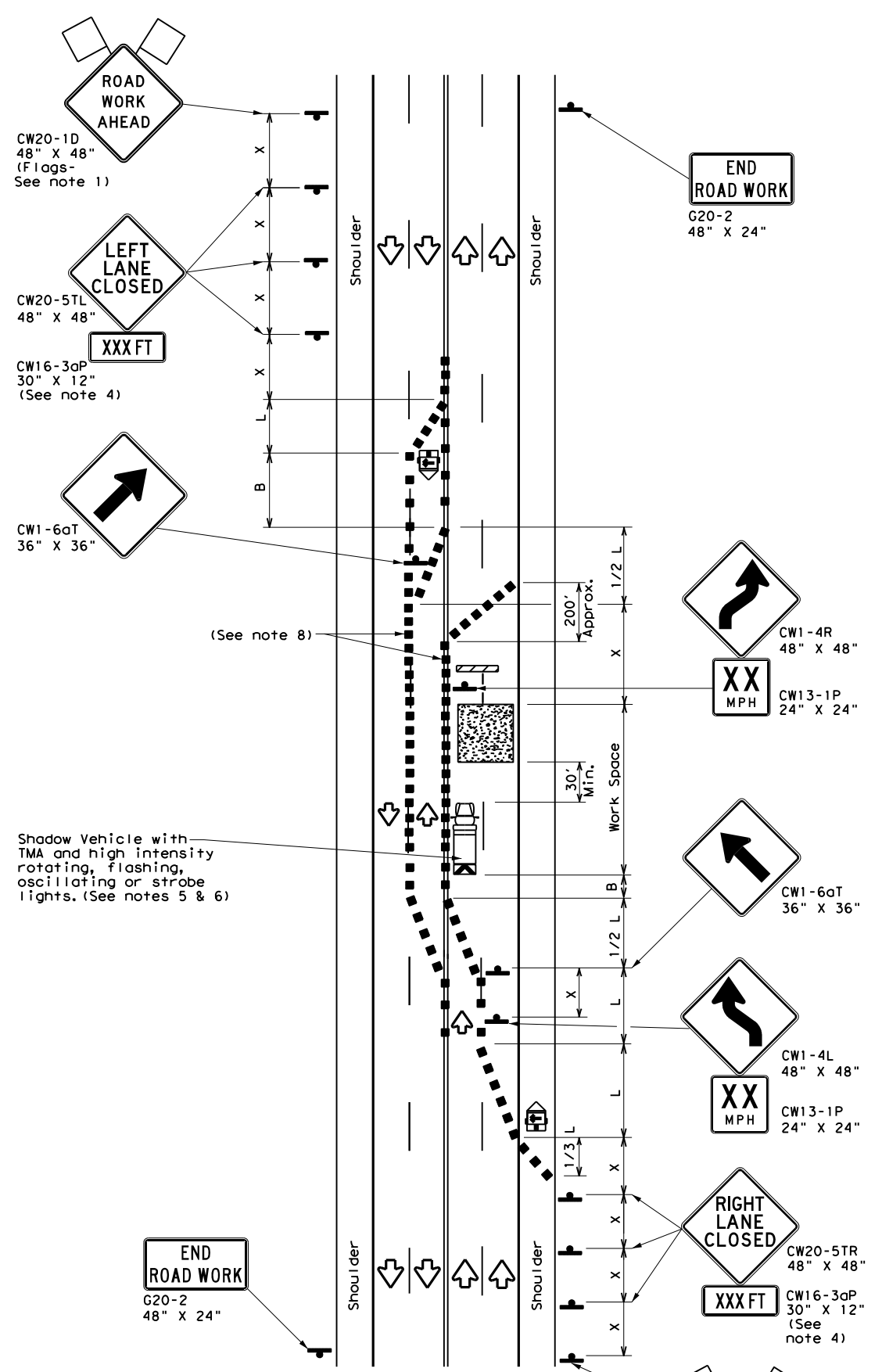

TCP (2-4b)  
**TWO LANES CLOSED**

**LEGEND**

	Type 3 Barricade		Channelizing Devices
	Heavy Work Vehicle		Truck Mounted Attenuator (TMA)
	Trailer Mounted Flashing Arrow Board		Portable Changeable Message Sign (PCMS)
	Sign		Traffic Flow
	Flag		Flagger

Posted Speed *	Formula	Minimum Desirable Taper Lengths **			Suggested Maximum Spacing of Channelizing Devices		Minimum Sign Spacing "x" Distance	Suggested Longitudinal Buffer Space "B"
		10' Offset	11' Offset	12' Offset	On a Taper	On a Tangent		
30	L = WS <sup>2</sup> / 60	150'	165'	180'	30'	60'	120'	90'
35		205'	225'	245'	35'	70'	160'	120'
40		265'	295'	320'	40'	80'	240'	155'
45	L = WS	450'	495'	540'	45'	90'	320'	195'
50		500'	550'	600'	50'	100'	400'	240'
55		550'	605'	660'	55'	110'	500'	295'
60		600'	660'	720'	60'	120'	600'	350'
65		650'	715'	780'	65'	130'	700'	410'
70		700'	770'	840'	70'	140'	800'	475'
75		750'	825'	900'	75'	150'	900'	540'

\* Conventional Roads Only  
 \*\* Taper lengths have been rounded off.  
 L=Length of Taper (FT) W=Width of Offset (FT) S=Posted Speed (MPH)

**TYPICAL USAGE**

MOBILE	SHORT DURATION	SHORT TERM STATIONARY	INTERMEDIATE TERM STATIONARY	LONG TERM STATIONARY
		✓	✓	

**GENERAL NOTES**

- Flags attached to signs where shown, are REQUIRED.
- All traffic control devices illustrated are REQUIRED, except those denoted with the triangle symbol may be omitted when stated elsewhere in the plans, or for routine maintenance work, when approved by the Engineer.
- The downstream taper is optional. When used, it should be 100 feet minimum length per lane.
- For short term applications, when post mounted signs are not used, the distance legend may be shown on the sign face rather than on a CW16-3aP supplemental plaque.
- A Shadow Vehicle with a TMA should be used anytime it can be positioned 30 to 100 feet in advance of the area of crew exposure without adversely affecting the performance or quality of the work. If workers are no longer present but road or work conditions require the traffic control to remain in place, Type 3 Barricades or other channelizing devices may be substituted for the Shadow Vehicle and TMA.
- Additional Shadow Vehicles with TMAs may be positioned in each closed lane, on the shoulder or off the paved surface, next to those shown in order to protect a wider work space.

**TCP (2-4a)**

- If this TCP is used for a left lane closure, CW20-5TL "LEFT LANE CLOSED" signs shall be used and channelizing devices shall be placed on the centerline to protect the work space from opposing traffic with the arrow board placed in the closed lane near the end of the merging taper.

**TCP (2-4b)**

- For shorter durations where traffic is directed over a yellow centerline, channelizing devices which separate two-way traffic should be spaced on tapers at 20' or 15' if posted speeds are 35 mph or slower, and for tangent sections, at 1/2(S) where S is the speed in mph. This tighter devices spacing is intended for the area of conflicting markings, not the entire work zone.



**TRAFFIC CONTROL PLAN  
 LANE CLOSURES ON MULTILANE  
 CONVENTIONAL ROADS**

**TCP (2-4) - 18**

FILE: tcp2-4-18.dgn	DN:	CK:	DW:	CK:
© TxDOT December 1985	CONT	SECT	JOB	HIGHWAY
REVISIONS	6393	46	001	IHO030
8-95 3-03	DIST	COUNTY	SHEET NO.	
1-97 2-12	18	DALLAS	28	
4-98 2-18				

DISCLAIMER: The use of this standard is governed by the "Texas Engineering Practice Act". No warranty of any kind is made by TxDOT for any purpose whatsoever. TxDOT assumes no responsibility for the conversion of units or the use of this standard in any project. This standard is not intended to be used for any project other than that for which it was developed.

DATE: 10/14/2021 11:03:29 AM  
 FILE: T:\DALAO\DALNEAO\Maint. Contracts\2022 RMC Folder\Tree Trimming and Brush Removal\6353\_02\6353\_02.dgn

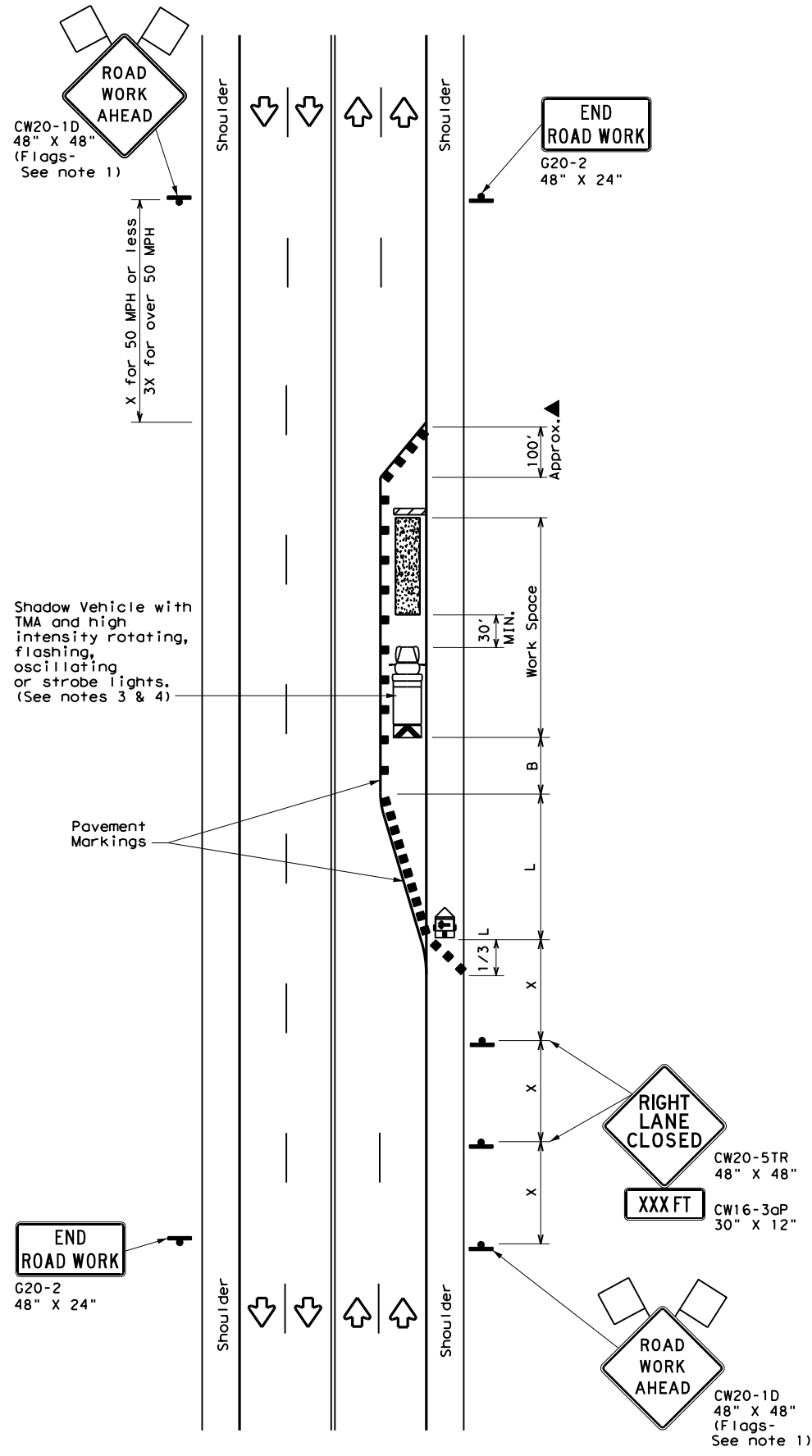

TCP (2-5a)  
**ONE LANE CLOSED**

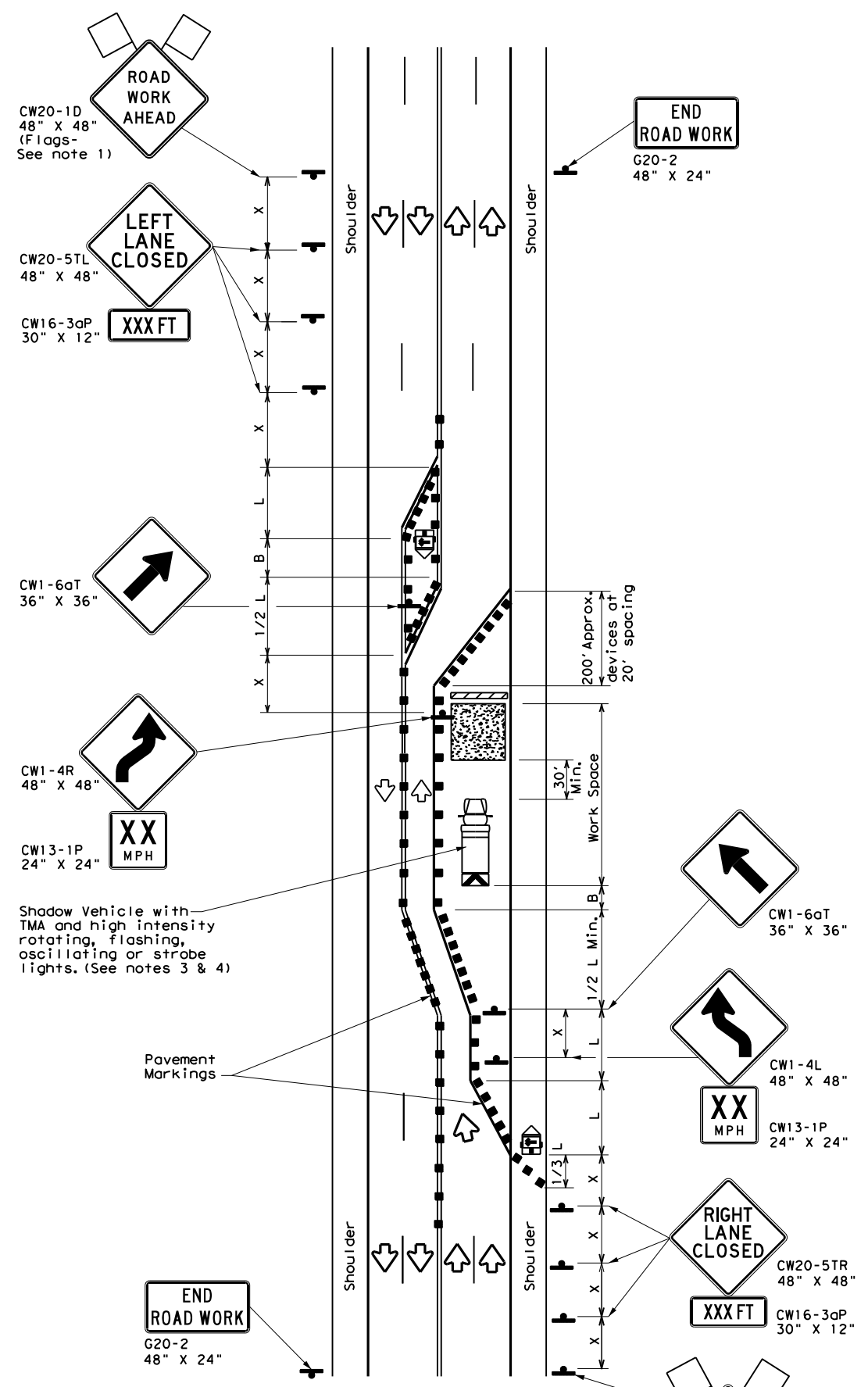

TCP (2-5b)  
**TWO LANES CLOSED**

LEGEND			
	Type 3 Barricade		Channelizing Devices
	Heavy Work Vehicle		Truck Mounted Attenuator (TMA)
	Trailer Mounted Flashing Arrow Board		Portable Changeable Message Sign (PCMS)
	Sign		Traffic Flow
	Flag		Flagger

Posted Speed *	Formula	Minimum Desirable Taper Lengths **			Suggested Maximum Spacing of Channelizing Devices		Minimum Sign Spacing "X" Distance	Suggested Longitudinal Buffer Space "B"
		10' Offset	11' Offset	12' Offset	On a Taper	On a Tangent		
30	L = WS <sup>2</sup> / 60	150'	165'	180'	30'	60'	120'	90'
35		205'	225'	245'	35'	70'	160'	120'
40		265'	295'	320'	40'	80'	240'	155'
45	L = WS	450'	495'	540'	45'	90'	320'	195'
50		500'	550'	600'	50'	100'	400'	240'
55		550'	605'	660'	55'	110'	500'	295'
60		600'	660'	720'	60'	120'	600'	350'
65		650'	715'	780'	65'	130'	700'	410'
70		700'	770'	840'	70'	140'	800'	475'
75		750'	825'	900'	75'	150'	900'	540'

\* Conventional Roads Only  
 \*\* Taper lengths have been rounded off.  
 L=Length of Taper (FT) W=Width of Offset (FT) S=Posted Speed (MPH)

TYPICAL USAGE				
MOBILE	SHORT DURATION	SHORT TERM STATIONARY	INTERMEDIATE TERM STATIONARY	LONG TERM STATIONARY
			✓	✓

- GENERAL NOTES**
- Flags attached to signs where shown, are REQUIRED.
  - All traffic control devices illustrated are REQUIRED, except those denoted with the triangle symbol may be omitted when stated elsewhere in the plans, or for routine maintenance work, when approved by the Engineer.
  - A Shadow Vehicle with a TMA should be used anytime it can be positioned 30 to 100 feet in advance of the area of crew exposure without adversely affecting the performance or quality of the work. If workers are no longer present but road or work conditions require the traffic control to remain in place, Type 3 Barricades or other channelizing devices may be substituted for the Shadow Vehicle and TMA.
  - Additional Shadow Vehicles with TMAs may be positioned in each closed lane, on the shoulder or off the paved surface, next to those shown in order to protect a wider work space.
  - The downstream taper is optional. When used, it should be 100 feet approximately per lane, with channelizing devices spaced at 20 feet.
- TCP (2-5a)**
- If this TCP is used for a left lane closure, CW20-5TL "LEFT LANE CLOSED" signs shall be used and channelizing devices shall be placed on the centerline to protect the work space from opposing traffic, with the arrow board placed in the closed lane near the end of the merging taper.
- TCP (2-5b)**
- Conflicting pavement markings shall be removed for long-term projects.

Texas Department of Transportation  
 Traffic Operations Division Standard

**TRAFFIC CONTROL PLAN**  
**LONG TERM LANE CLOSURES**  
**MULTILANE CONVENTIONAL RDS.**

**TCP (2-5) - 18**

FILE: tcp2-5-18.dgn	DN:	CK:	DW:	CK:
© TxDOT December 1985	CONT	SECT	JOB	HIGHWAY
8-95 2-12 REVISIONS	6393	46	001	IH0030
1-97 3-03	DIST	COUNTY	SHEET NO.	
4-98 2-18	18	DALLAS	29	

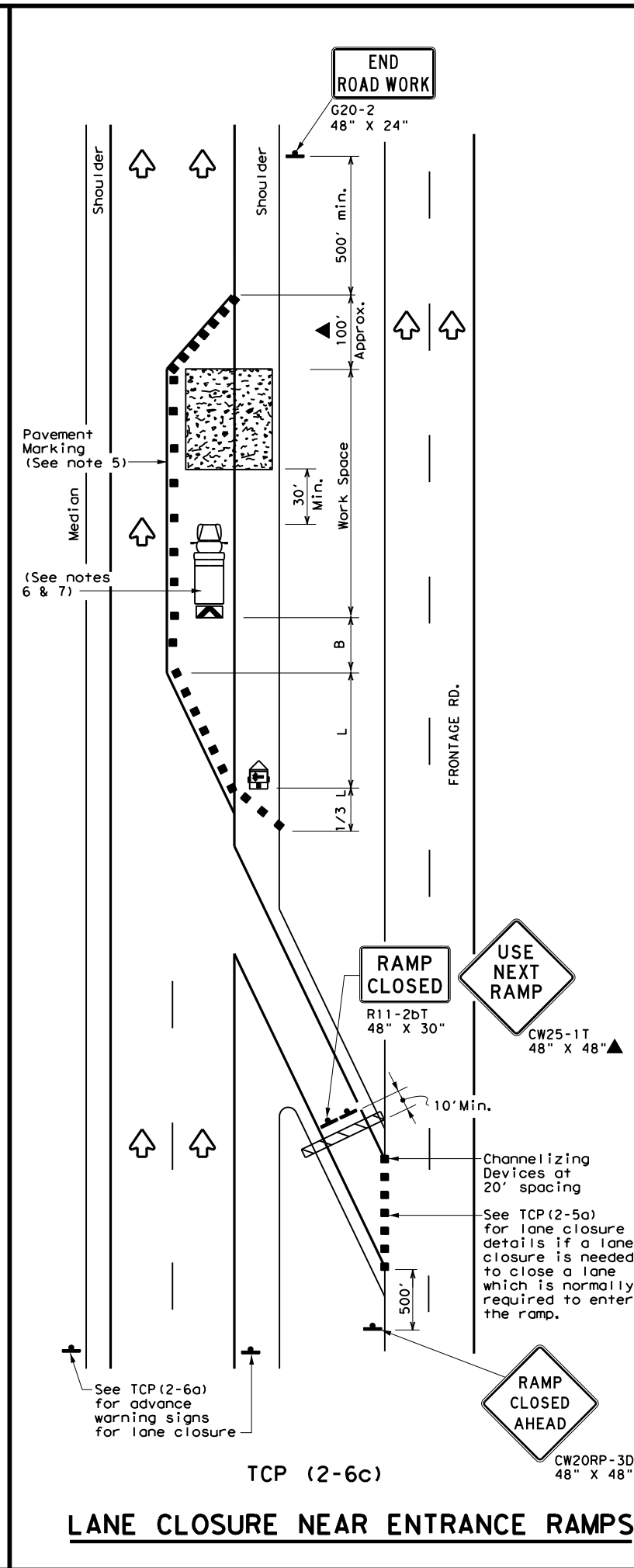
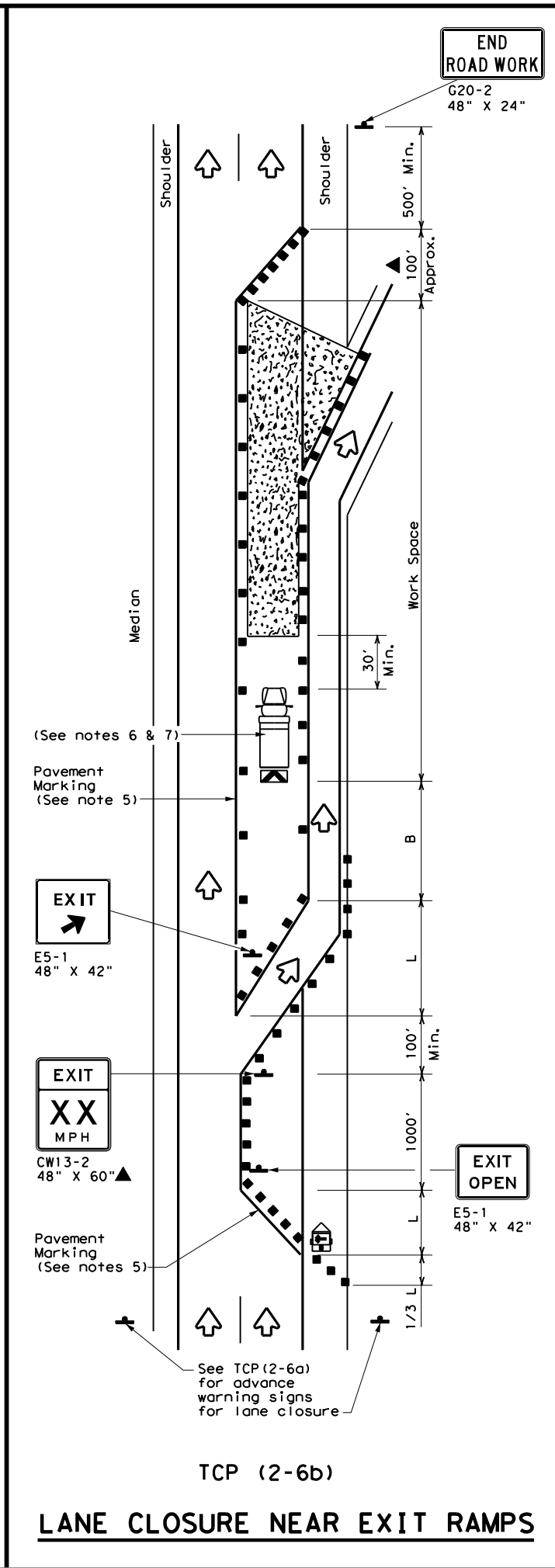
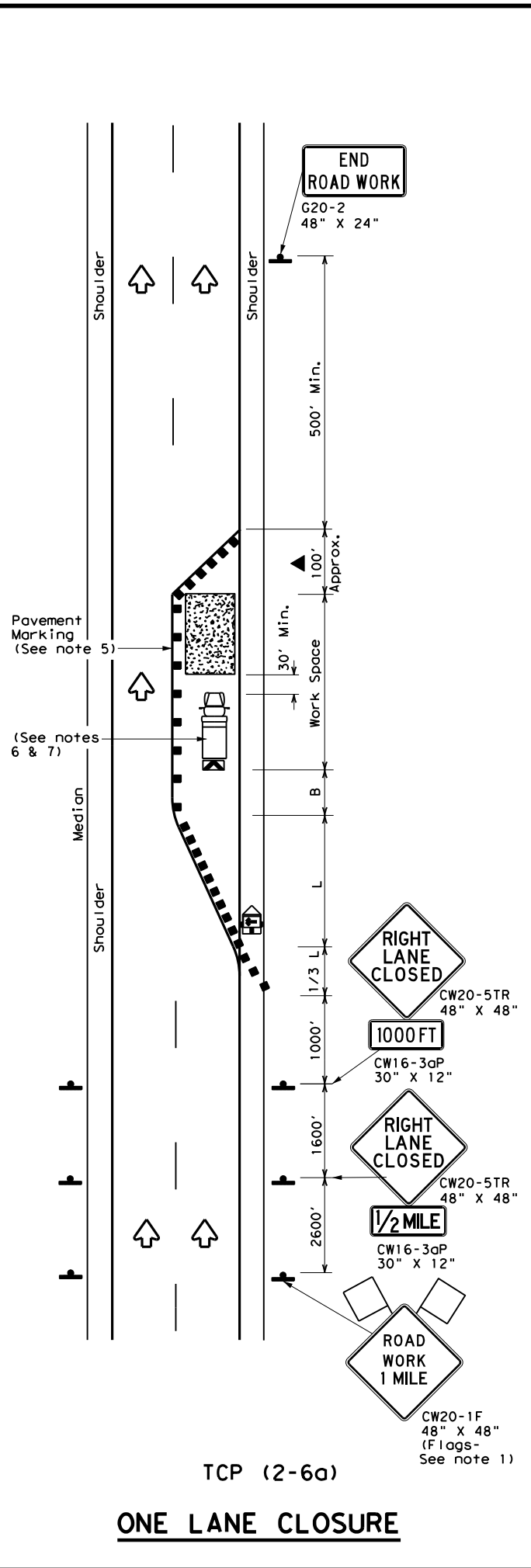

	Type 3 Barricade		Channelizing Devices
	Heavy Work Vehicle		Truck Mounted Attenuator (TMA)
	Trailer Mounted Flashing Arrow Board		Portable Changeable Message Sign (PCMS)
	Sign		Traffic Flow
	Flag		Flagger

Posted Speed *	Formula	Minimum Desirable Taper Lengths **			Suggested Maximum Spacing of Channelizing Devices		Minimum Sign Spacing "X" Distance	Suggested Longitudinal Buffer Space "B"
		10' Offset	11' Offset	12' Offset	On a Taper	On a Tangent		
30	L = WS <sup>2</sup> / 60	150'	165'	180'	30'	60'	120'	90'
35		205'	225'	245'	35'	70'	160'	120'
40		265'	295'	320'	40'	80'	240'	155'
45	L = WS	450'	495'	540'	45'	90'	320'	195'
50		500'	550'	600'	50'	100'	400'	240'
55		550'	605'	660'	55'	110'	500'	295'
60		600'	660'	720'	60'	120'	600'	350'
65		650'	715'	780'	65'	130'	700'	410'
70	700'	770'	840'	70'	140'	800'	475'	
75	750'	825'	900'	75'	150'	900'	540'	

\* Conventional Roads Only  
\*\* Taper lengths have been rounded off.  
L=Length of Taper (FT) W=Width of Offset (FT) S=Posted Speed (MPH)

MOBILE	SHORT DURATION	SHORT TERM STATIONARY	INTERMEDIATE TERM STATIONARY	LONG TERM STATIONARY
			✓	✓

- GENERAL NOTES**
- Flags attached to signs where shown, are REQUIRED.
  - All traffic control devices illustrated are REQUIRED, except those denoted with the triangle symbol may be omitted when stated elsewhere in the plans, or for routine maintenance work, when approved by the Engineer.
  - Channelizing devices used to close lanes may be supplemented with the Chevron Alignment Sign placed on every other channelizing device. Chevrons may be attached to plastic drums as per BC Standards.
  - Channelizing devices used along the work space or along tangent sections may be supplemented with vertical panels (VP) placed on every other channelizing device. If night time conditions make it difficult to see at least two VPs, the VPs may be placed on each channelizing device.
  - The placement of pavement markings may be omitted on intermediate-term stationary work zones with the approval of the Engineer.
  - Shadow Vehicle with TMA and high intensity rotating, flashing, oscillating or strobe lights. A Shadow Vehicle with a TMA should be used anytime it can be positioned 30 to 100 feet in advance of the area of crew exposure without adversely affecting the performance or quality of the work. If workers are no longer present but road or work conditions require the traffic control to remain in place, Type 3 Barricades or other channelizing devices may be substituted for the Shadow Vehicle and TMA.
  - Additional Shadow Vehicles with TMAs may be positioned in each closed lane, on the shoulder or off the paved surface, next to those shown in order to protect a wider work space.



### TRAFFIC CONTROL PLAN LANE CLOSURES ON DIVIDED HIGHWAYS

## TCP (2-6) - 18

FILE: tcp2-6-18.dgn    DWN:    CK:    DW:    CK:

© TxDOT December 1985    CONT    SECT    JOB    HIGHWAY

REVISIONS	6393	46	001	IHO030
2-94 4-98				
8-95 2-12				
1-97 2-18	18		DALLAS	30

166



DISCLAIMER: The use of this standard is governed by the "Texas Engineering Practice Act". No warranty of any kind is made by TxDOT for any purpose whatsoever. TxDOT assumes no responsibility for the conversion of units or the use of this standard in any other manner.

DATE: 10/14/2021 11:03:35 AM  
 FILE: T:\DALAO\DALNEAO\Maint. Contracts\2022 RMC Folder\Tree Trimming and Brush Removal\6393-46\6393-46.dgn

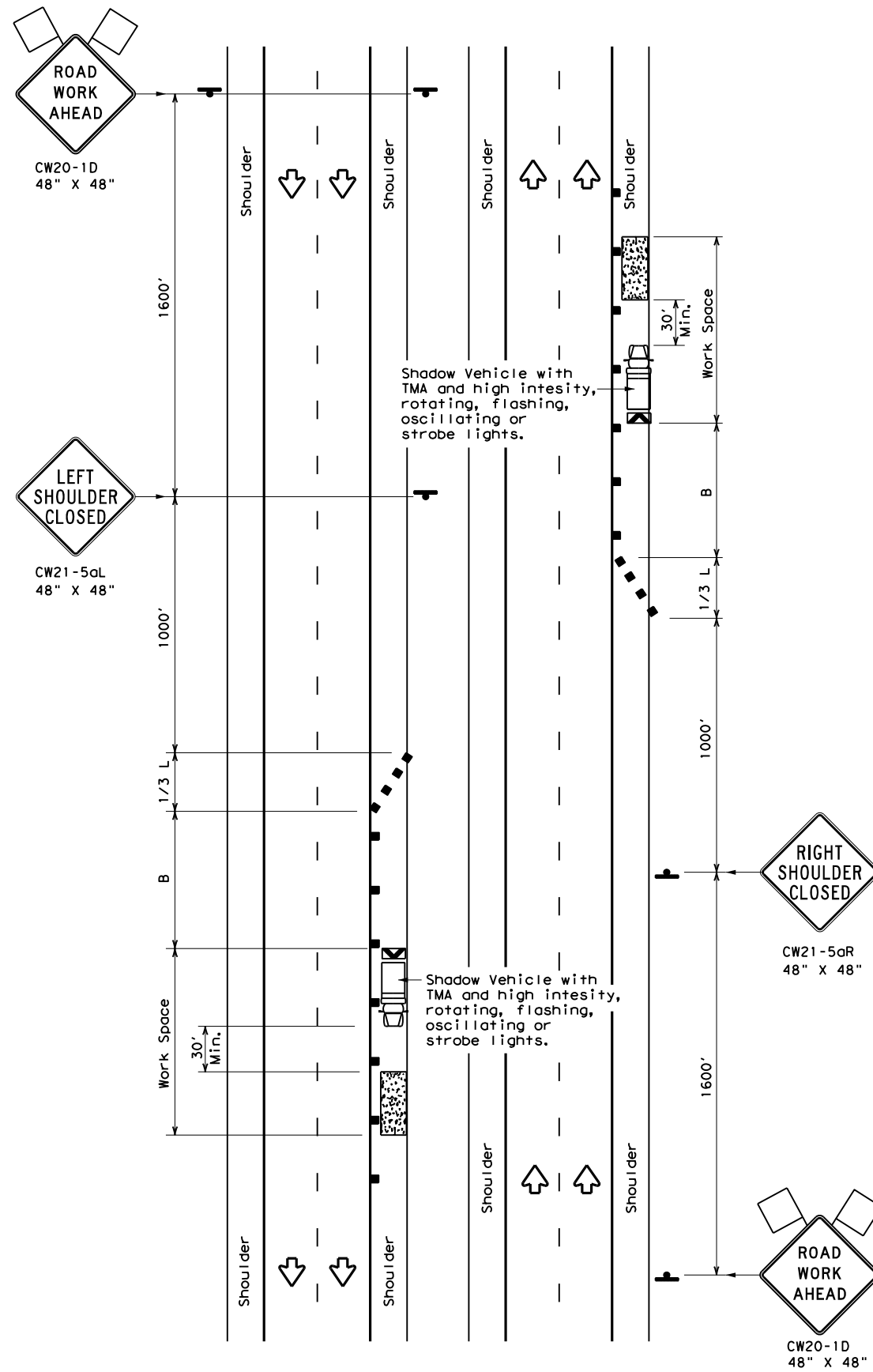

TCP (5-1a)

**WORK AREA ON SHOULDER**

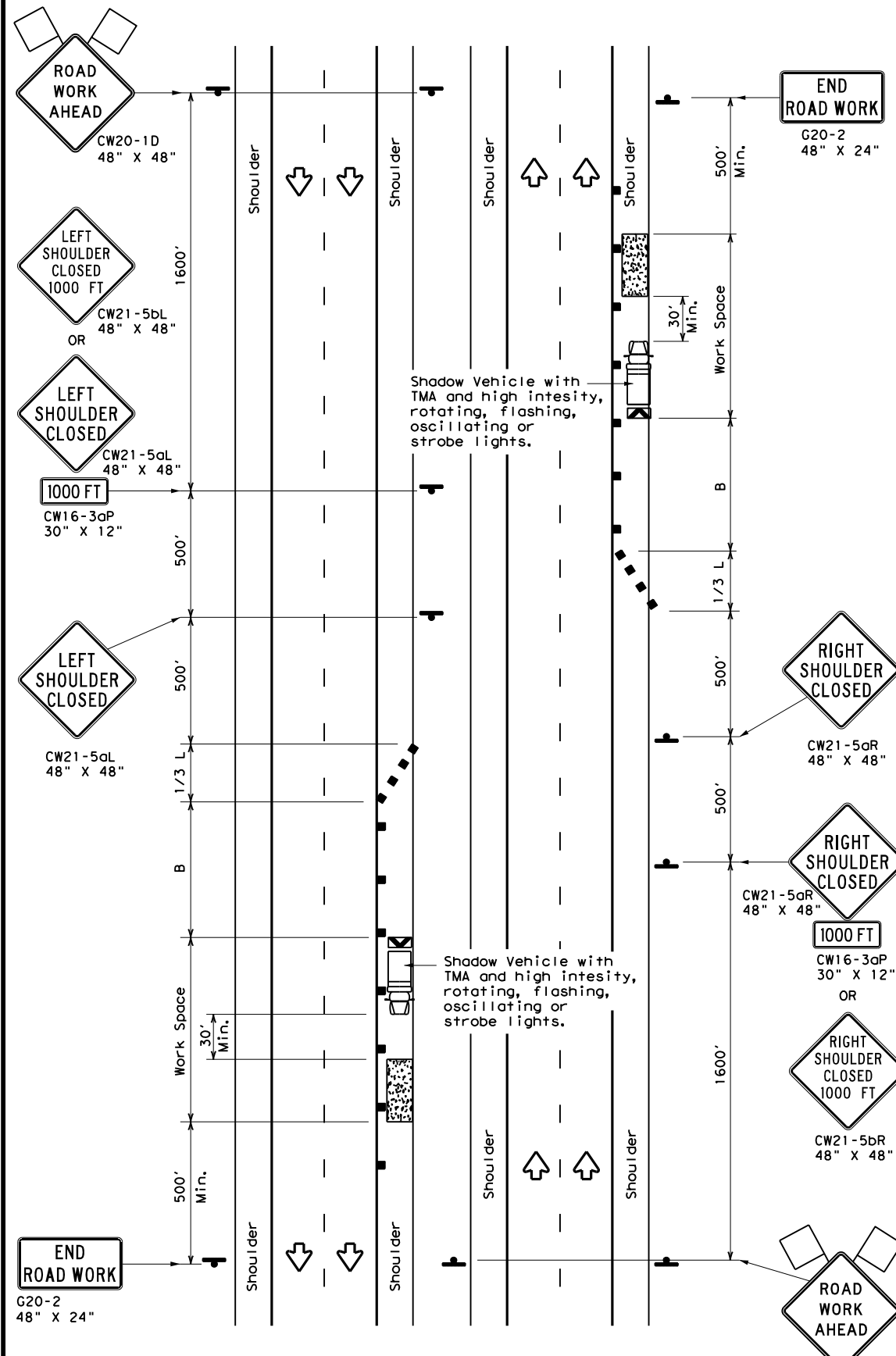

TCP (5-1b)

**WORK AREA ON SHOULDER**

LEGEND			
	Type 3 Barricade		Channelizing Devices
	Heavy Work Vehicle		Truck Mounted Attenuator (TMA)
	Trailer Mounted Flashing Arrow Board		Portable Changeable Message Sign (PCMS)
	Sign		Traffic Flow
	Flag		Flagger

Posted Speed *	Formula	Minimum Desirable Taper Lengths **			Suggested Maximum Spacing of Channelizing Devices		Suggested Longitudinal Buffer Space "B"
		10' Offset	11' Offset	12' Offset	On a Taper	On a Tangent	
30	L = WS <sup>2</sup> / 60	150'	165'	180'	30'	60'	90'
35		205'	225'	245'	35'	70'	120'
40		265'	295'	320'	40'	80'	155'
45	L = WS	450'	495'	540'	45'	90'	195'
50		500'	550'	600'	50'	100'	240'
55		550'	605'	660'	55'	110'	295'
60		600'	660'	720'	60'	120'	350'
65		650'	715'	780'	65'	130'	410'
70		700'	770'	840'	70'	140'	475'
75		750'	825'	900'	75'	150'	540'
80		800'	880'	960'	80'	160'	615'

\* Conventional Roads Only  
 \*\* Taper lengths have been rounded off.  
 L=Length of Taper (FT) W=Width of Offset (FT) S=Posted Speed (MPH)

TYPICAL USAGE				
MOBILE	SHORT DURATION	SHORT TERM STATIONARY	INTERMEDIATE TERM STATIONARY	LONG TERM STATIONARY
	TCP (5-1a)	TCP (5-1b)	TCP (5-1b)	

**GENERAL NOTES**

1. A Shadow Vehicle with a TMA should be used anytime it can be positioned 30' to 100' in advance of the area of crew exposure without adversely affecting the performance or quality of the work. Type 3 barricades or drums may be substituted when workers on foot are no longer present when approved by the Engineer.
2. 28" tall or taller one-piece cones will be allowed only for Short Duration or Short Term stationary operations when workers are present to maintain the devices upright and in proper location. Intermediate Term stationary work areas should use Drums, Vertical Panels or 42" tall two-piece cones.



**TRAFFIC CONTROL PLAN  
 SHOULDER WORK FOR  
 FREEWAYS / EXPRESSWAYS**

**TCP (5-1) - 18**

FILE: tcp5-1-18.dgn	DN:	CK:	DW:	CK:
© TxDOT February 2012	CONT	SECT	JOB	HIGHWAY
REVISIONS	6393	46	001	IHO030
2-18	DIST	COUNTY	SHEET NO.	
	18	DALLAS	31	

DATE: 10/14/2021 11:03:37 AM  
 FILE: T:\DALAO\DALNEAO\Maint. Contracts\2022 RMC Folder\Tree Trimming and Brush Removal\1033 09100 for RMC & Trenches Removal\09100 for RMC & Trenches Removal.dwg  
 DISCLAIMER: The use of this standard is governed by the "Texas Engineering Practice Act". No warranty of any kind is made by TxDOT for any purpose whatsoever. TxDOT assumes no responsibility for the conversion of electronic files to paper or for any errors or omissions in the printed version of this standard.

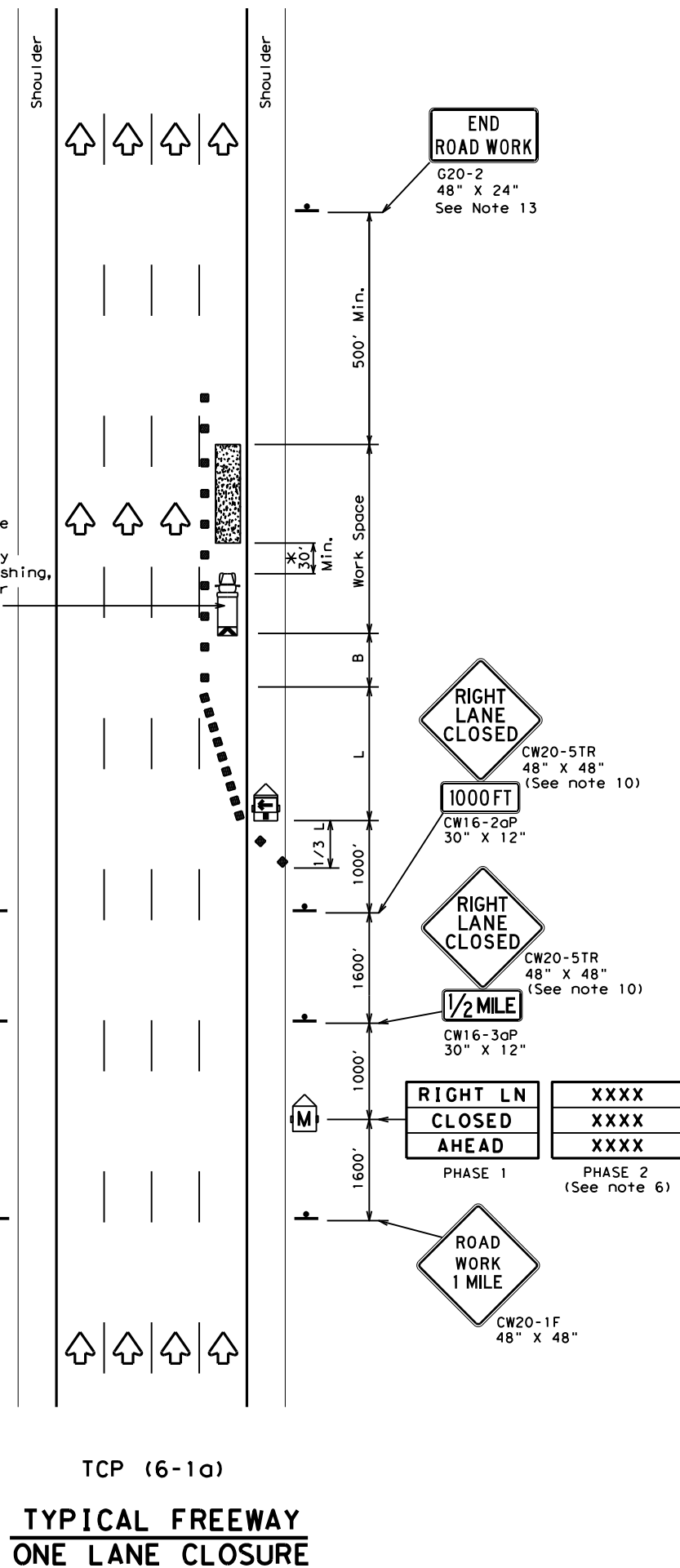

TCP (6-1a)  
**TYPICAL FREEWAY ONE LANE CLOSURE**

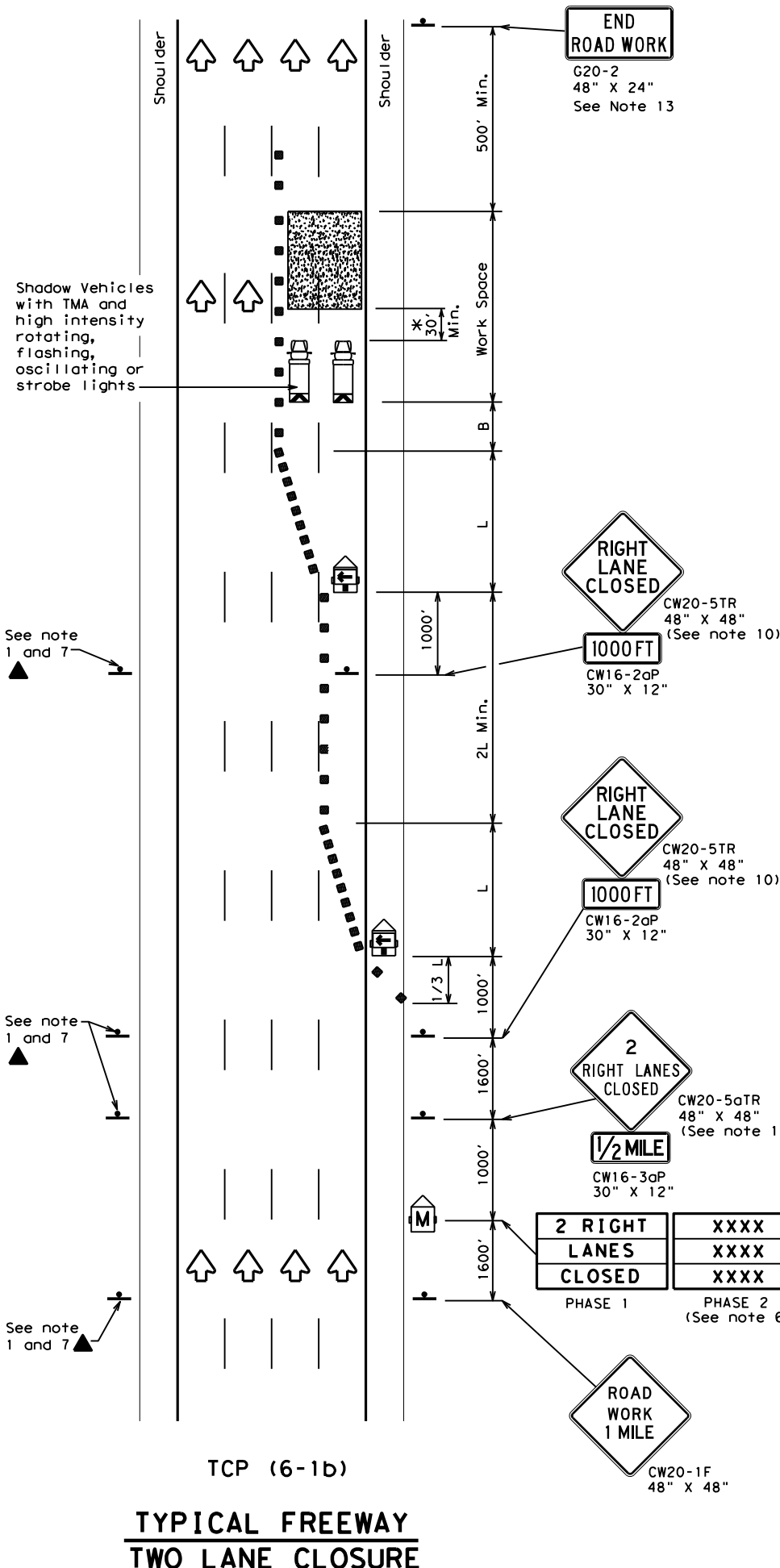

TCP (6-1b)  
**TYPICAL FREEWAY TWO LANE CLOSURE**

LEGEND			
	Type 3 Barricade		Channelizing Devices
	Heavy Work Vehicle		Truck Mounted Attenuator (TMA)
	Trailer Mounted Flashing Arrow Board		Portable Changeable Message Sign (PCMS)
	Sign		Traffic Flow
	Flag		Flagger

Posted Speed	Formula	Minimum Desirable Taper Lengths "L"			Suggested Maximum Spacing of Channelizing Devices		Suggested Longitudinal Buffer Space "B"
		10' Offset	11' Offset	12' Offset	On a Taper	On a Tangent	
45	L = WS	450'	495'	540'	45'	90'	195'
50		500'	550'	600'	50'	100'	240'
55		550'	605'	660'	55'	110'	295'
60		600'	660'	720'	60'	120'	350'
65		650'	715'	780'	65'	130'	410'
70		700'	770'	840'	70'	140'	475'
75		750'	825'	900'	75'	150'	540'
80	800'	880'	960'	80'	160'	615'	

\*\* Taper lengths have been rounded off.  
 L=Length of Taper (FT) W=Width of Offset (FT) S=Posted Speed (MPH)

TYPICAL USAGE				
MOBILE	SHORT DURATION	SHORT TERM STATIONARY	INTERMEDIATE TERM STATIONARY	LONG TERM STATIONARY
	✓	✓	✓	

**GENERAL NOTES**

- All traffic control devices illustrated are REQUIRED. Devices denoted with the triangle symbol may be omitted when stated elsewhere in the plans.
- Drums or 42" cones are the typical channelizing devices. For Intermediate Term Stationary work, drums shall be used on tapers with drums or 42" cones used on tangent sections. Other channelizing devices may be used as directed by the Engineer.
- All construction signs and barricades placed during any phase of work shall remain in place until removal is approved by the Engineer.
- The Engineer may direct the Contractor to furnish additional signs and barricades as required to maintain traffic flow, detours and motorist safety during construction.
- Static message boards or changeable message signs stating the date and duration of ramp or freeway lane closures shall be placed a minimum of seven (7) calendar days in advance of the actual closure.
- Phase 2 of the PCMS message should include appropriate information formatted as shown on BC(6), such as "MERGE LEFT," recommended advisory speed, delay information, or other specific warnings.
- Duplicate construction warning signs should be erected on the medians side of freeways where median width will permit and traffic volume justifies the signing.
- The number of closed lanes may be increased provided the spacing of traffic control devices, taper lengths and tangent lengths meet the requirements of the TMUTCD.
- Warning signs for intermediate term stationary work should be mounted at 7' to the bottom of the sign.
- Warning signs shown shall be appropriately altered for left lane closures. When signs are mounted at 1' height for short term stationary or short duration work, sign versions shown in the SHSD for Texas with distances on the sign face rather than mounted on a plaque below the sign may be used.
- When possible, PCMS units should be located in advance of the last available exit ramp prior to the lane closure to allow motorists an alternate route. They may also be relocated to improve advance warning in case of unanticipated queuing or congestion.
- For Intermediate Term Stationary work at night, floodlights should be used to illuminate the work area and equipment crossings. Floodlights shall not produce a disabling glare condition for road users or workers.
- The END ROAD WORK (G20-2) sign may be omitted when it conflicts with G20-2 signs already in place on the project.

\* A shadow vehicle equipped with a Truck Mounted Attenuator is typically required. A shadow vehicle equipped with a TMA shall be used if it can be positioned 30' to 100' in advance of the area of crew exposure without adversely affecting the work performance.

Texas Department of Transportation  
 Traffic Operations Division Standard

**TRAFFIC CONTROL PLAN  
 FREEWAY LANE CLOSURES**

**TCP (6-1) - 12**

FILE:	tcp6-1.dgn	DN:	TxDOT	CK:	TxDOT	DW:	TxDOT	CK:	TxDOT
©TxDOT	February 1998	CONT	SECT	JOB	HIGHWAY				
8-12	REVISIONS	6393	46	001	IH0030				
	DIST	COUNTY	SHEET NO.						
	18	DALLAS	32						

DISCLAIMER: The use of this standard is governed by the "Texas Engineering Practice Act". No warranty of any kind is made by TxDOT for any purpose whatsoever. TxDOT assumes no responsibility for the conversion of units or the use of this standard in any manner other than that intended by the original author.

DATE: 10/14/2021 11:03:40 AM  
 FILE: T:\DALAO\DALNEAO\Maint. Contracts\2022 RMC Folder\Tree Trimming and Brush Removal\639346\639346.dgn

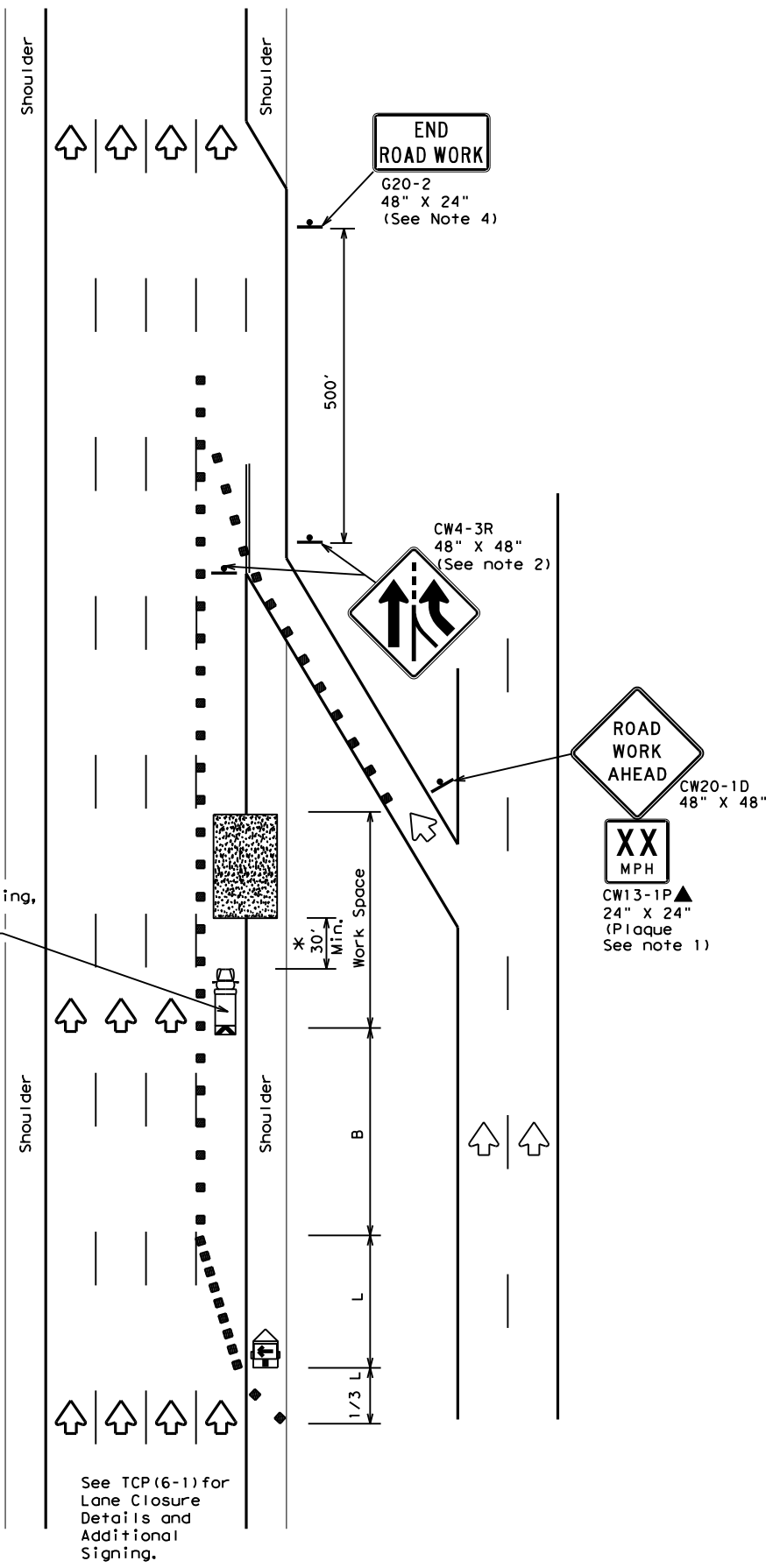

TCP (6-2a)  
**ENTRANCE RAMP OPEN**  
**WORK WITHIN 500' OF RAMP**

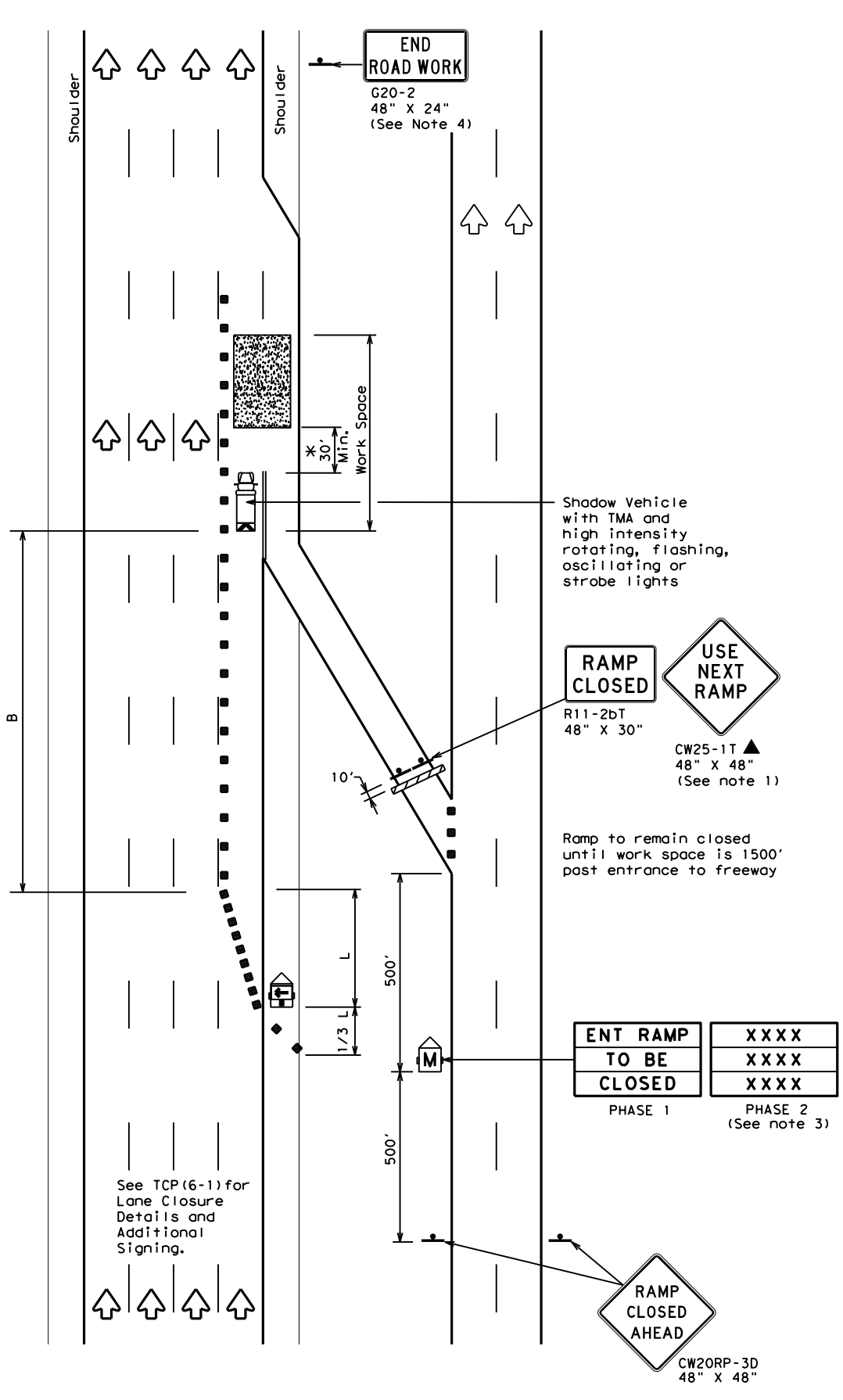

TCP (6-2b)  
**ENTRANCE RAMP CLOSED**

LEGEND			
	Type 3 Barricade		Channelizing Devices
	Heavy Work Vehicle		Truck Mounted Attenuator (TMA)
	Trailer Mounted Flashing Arrow Board		Portable Changeable Message Sign (PCMS)
	Sign		Traffic Flow
	Flag		Flagger

Posted Speed	Formula	Minimum Desirable Taper Lengths "L"			Suggested Maximum Spacing of Channelizing Devices		Suggested Longitudinal Buffer Space "B"
		10' Offset	11' Offset	12' Offset	On a Taper	On a Tangent	
45	L = WS	450'	495'	540'	45'	90'	195'
50		500'	550'	600'	50'	100'	240'
55		550'	605'	660'	55'	110'	295'
60		600'	660'	720'	60'	120'	350'
65		650'	715'	780'	65'	130'	410'
70		700'	770'	840'	70'	140'	475'
75		750'	825'	900'	75'	150'	540'
80		800'	880'	960'	80'	160'	615'

\*\* Taper lengths have been rounded off.  
 L=Length of Taper (FT) W=Width of Offset(FT) S=Posted Speed(MPH)

TYPICAL USAGE				
MOBILE	SHORT DURATION	SHORT TERM STATIONARY	INTERMEDIATE TERM STATIONARY	LONG TERM STATIONARY
	✓	✓	✓	

- GENERAL NOTES**
- All traffic control devices illustrated are REQUIRED. Devices denoted with the triangle symbol may be omitted when stated elsewhere in the plans.
  - ADDED LANE Symbol (CW4-3) sign may be omitted when sign between ramp and mainline can be seen from both roadways.
  - See "Advance Notice List" on BC(6) for recommended date and time formatting options for PCMS Phase 2 message.
  - The END ROAD WORK (G20-2) sign may be omitted when it conflicts with G20-2 signs already in place on the project.

\*A shadow vehicle equipped with a Truck Mounted Attenuator is typically required. A shadow vehicle equipped with a TMA shall be used if it can be positioned 30' to 100' in advance of the area of crew exposure without adversely affecting the work performance.

Additional requirements for lane closures and advance signing shall be as shown on TCP (6-1) or as directed by the Engineer.



**TRAFFIC CONTROL PLAN**  
**WORK AREA NEAR RAMP**

**TCP (6-2) - 12**

FILE: tcp6-2.dgn	DN: TxDOT	CK: TxDOT	DW: TxDOT	CK: TxDOT
©TxDOT February 1994	CONT	SECT	JOB	HIGHWAY
REVISIONS	6393	46	001	IH0030
1-97 8-98	DIST	COUNTY	SHEET NO.	
4-98 8-12	18	DALLAS	33	

DISCLAIMER: The use of this standard is governed by the "Texas Engineering Practice Act". No warranty of any kind is made by TxDOT for any purpose whatsoever. TxDOT assumes no responsibility for the conversion of units or the use of this standard in any manner other than that intended by the original author.

DATE: 10/14/2021 11:03:42 AM  
 FILE: T:\DALAO\DALNEAO\Maint. Contracts\2022 RMC Folder\Tree Trimming and Brush Removal\06353\_06353.dwg

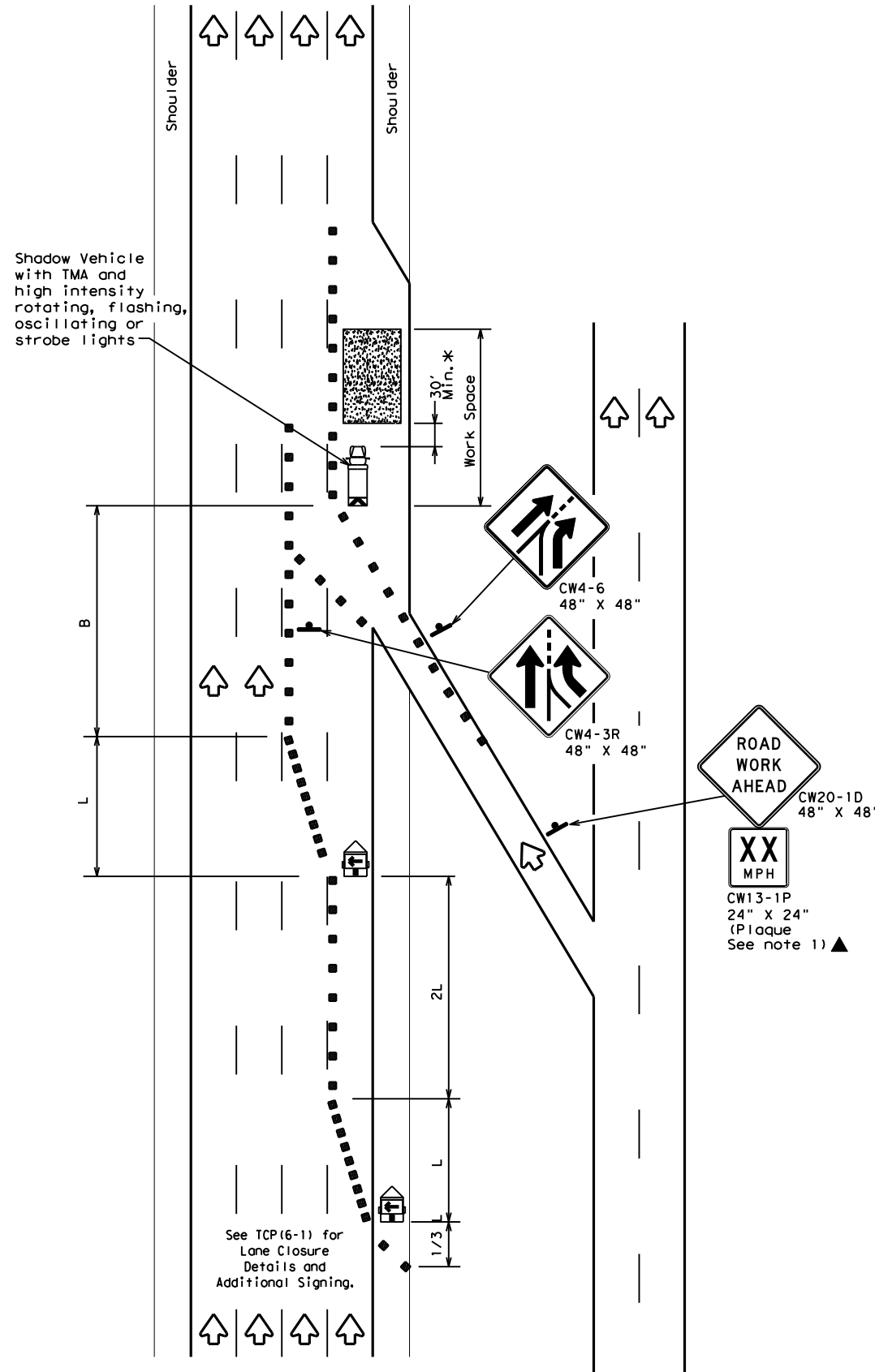

TCP (6-3a)  
**ENTRANCE RAMP OPEN**

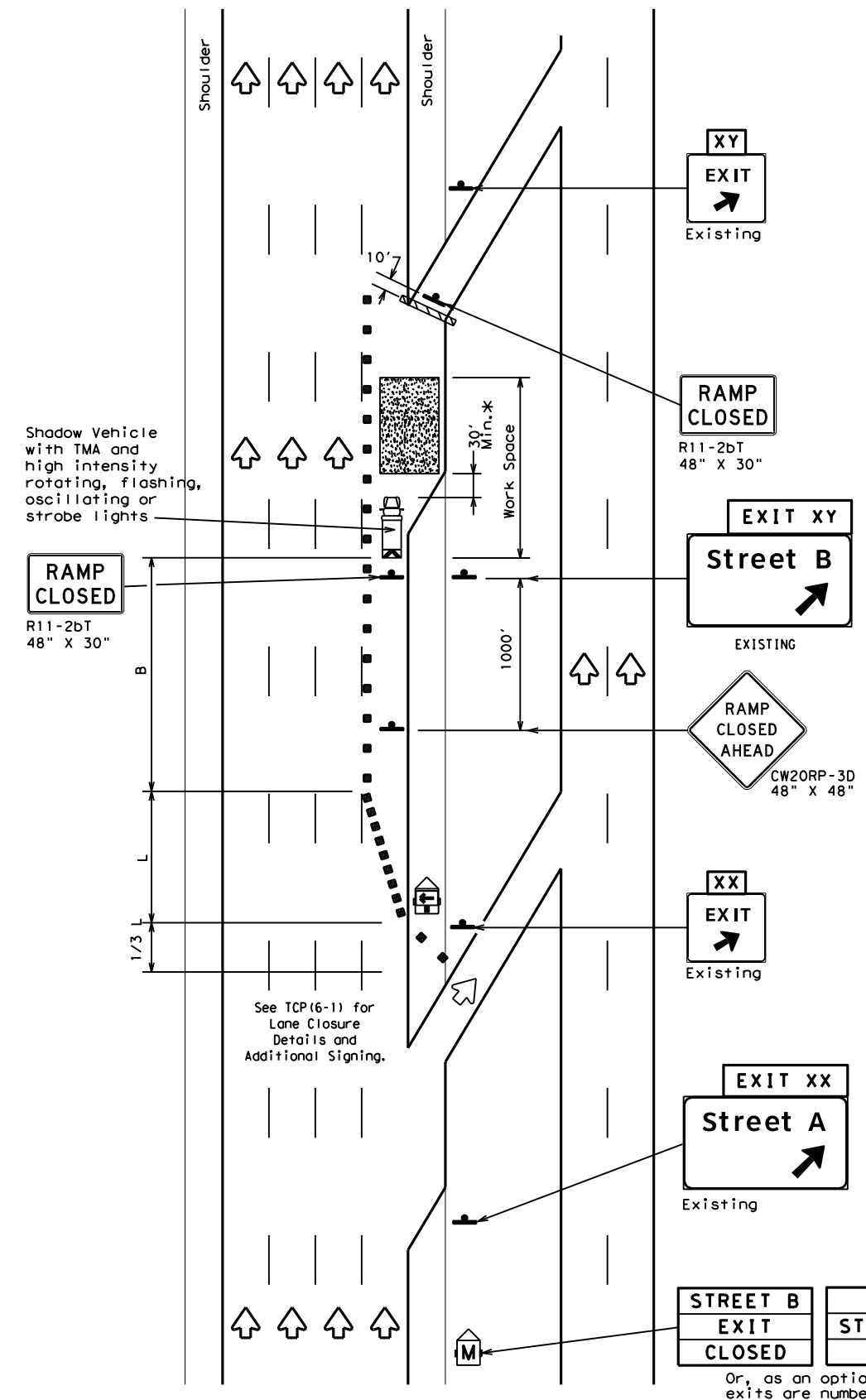

TCP (6-3b)  
**EXIT RAMP CLOSED**  
**TRAFFIC EXITS PRIOR TO CLOSED RAMP**

LEGEND			
	Type 3 Barricade		Channelizing Devices
	Heavy Work Vehicle		Truck Mounted Attenuator (TMA)
	Trailer Mounted Flashing Arrow Board		Portable Changeable Message Sign (PCMS)
	Sign		Traffic Flow
	Flag		Flagger

Posted Speed	Formula	Minimum Desirable Taper Lengths "L" **			Suggested Maximum Spacing of Channelizing Devices		Suggested Longitudinal Buffer Space "B"
		10' Offset	11' Offset	12' Offset	On a Taper	On a Tangent	
45	L = WS	450'	495'	540'	45'	90'	195'
50		500'	550'	600'	50'	100'	240'
55		550'	605'	660'	55'	110'	295'
60		600'	660'	720'	60'	120'	350'
65		650'	715'	780'	65'	130'	410'
70		700'	770'	840'	70'	140'	475'
75		750'	825'	900'	75'	150'	540'
80		800'	880'	960'	80'	160'	615'

\*\* Taper lengths have been rounded off.  
 L=Length of Taper (FT) W=Width of Offset (FT) S=Posted Speed (MPH)

TYPICAL USAGE				
MOBILE	SHORT DURATION	SHORT TERM STATIONARY	INTERMEDIATE TERM STATIONARY	LONG TERM STATIONARY
	✓	✓	✓	

GENERAL NOTES:

- All traffic control devices illustrated are REQUIRED. Devices denoted with the triangle symbol may be omitted when stated elsewhere in the plans.

\*A shadow vehicle equipped with a Truck Mounted Attenuator is typically required. A shadow vehicle equipped with a TMA shall be used if it can be positioned 30' to 100' in advance of the area of crew exposure without adversely affecting the work performance.

Additional requirements for lane closures and advance signing shall be as shown on TCP (6-1) or as directed by the Engineer.

Texas Department of Transportation  
 Traffic Operations Division Standard

**TRAFFIC CONTROL PLAN  
 WORK AREA BEYOND RAMP**

**TCP (6-3) - 12**

FILE: tcp6-3.dgn	DN: TxDOT	CK: TxDOT	DW: TxDOT	CR: TxDOT
©TxDOT February 1994	CONT	SECT	JOB	HIGHWAY
REVISIONS	6393	46	001	IHO030
1-97 8-98	DIST	COUNTY	SHEET NO.	
4-98 8-12	18	DALLAS	34	

DISCLAIMER: The use of this standard is governed by the "Texas Engineering Practice Act". No warranty of any kind is made by TxDOT for any purpose whatsoever. TxDOT assumes no responsibility for the conversion of units or the use of this standard in any manner other than that intended by the original author.

DATE: 10/14/2021 11:03:45 AM  
 FILE: T:\DALAO\DALNEAO\Maint. Contracts\2022 RMC Folder\Tree Trimming and Brush Removal\TCPS\TCPS.dwg

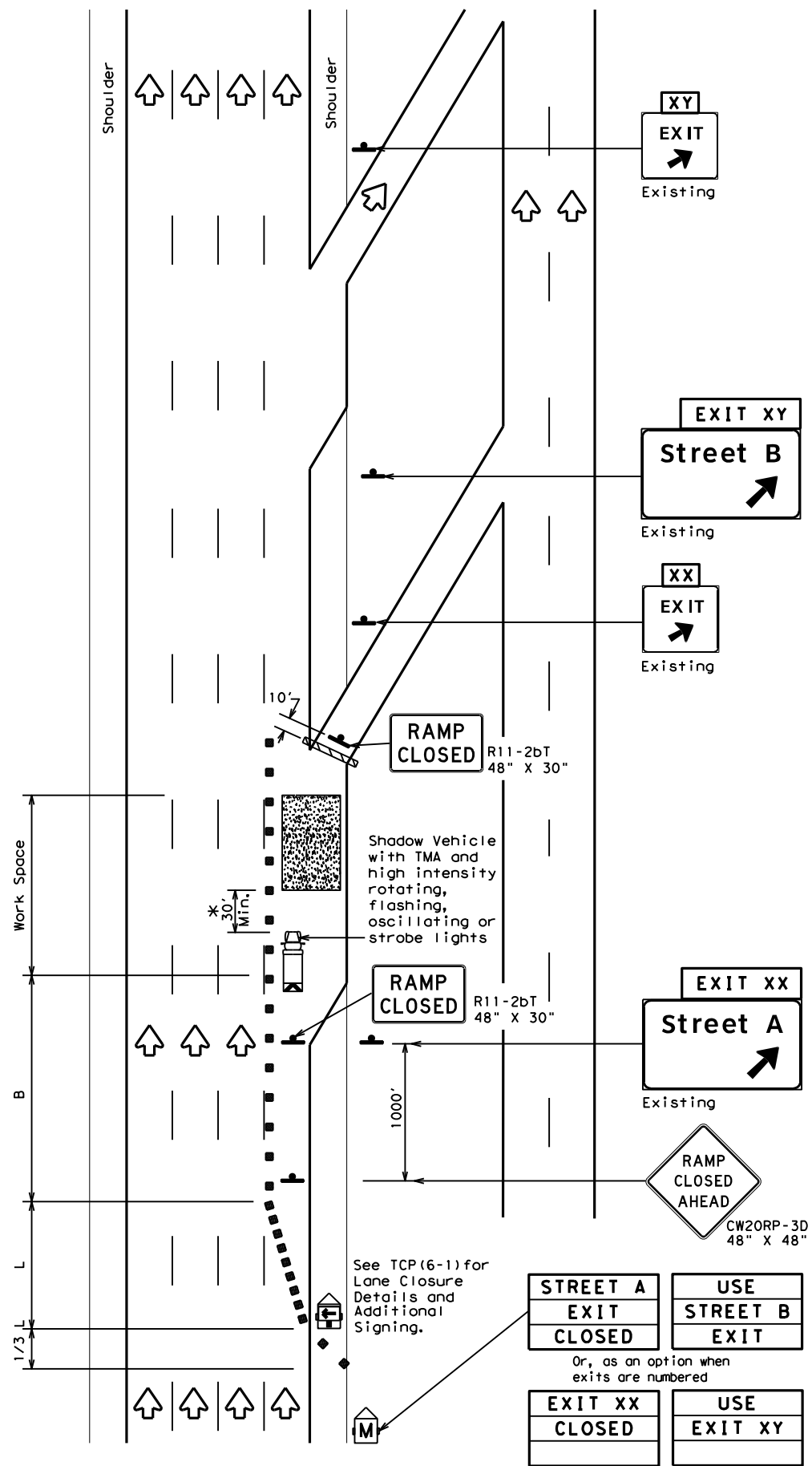

TCP (6-4a)  
**EXIT RAMP CLOSED**  
**TRAFFIC EXITS PAST CLOSED RAMP**

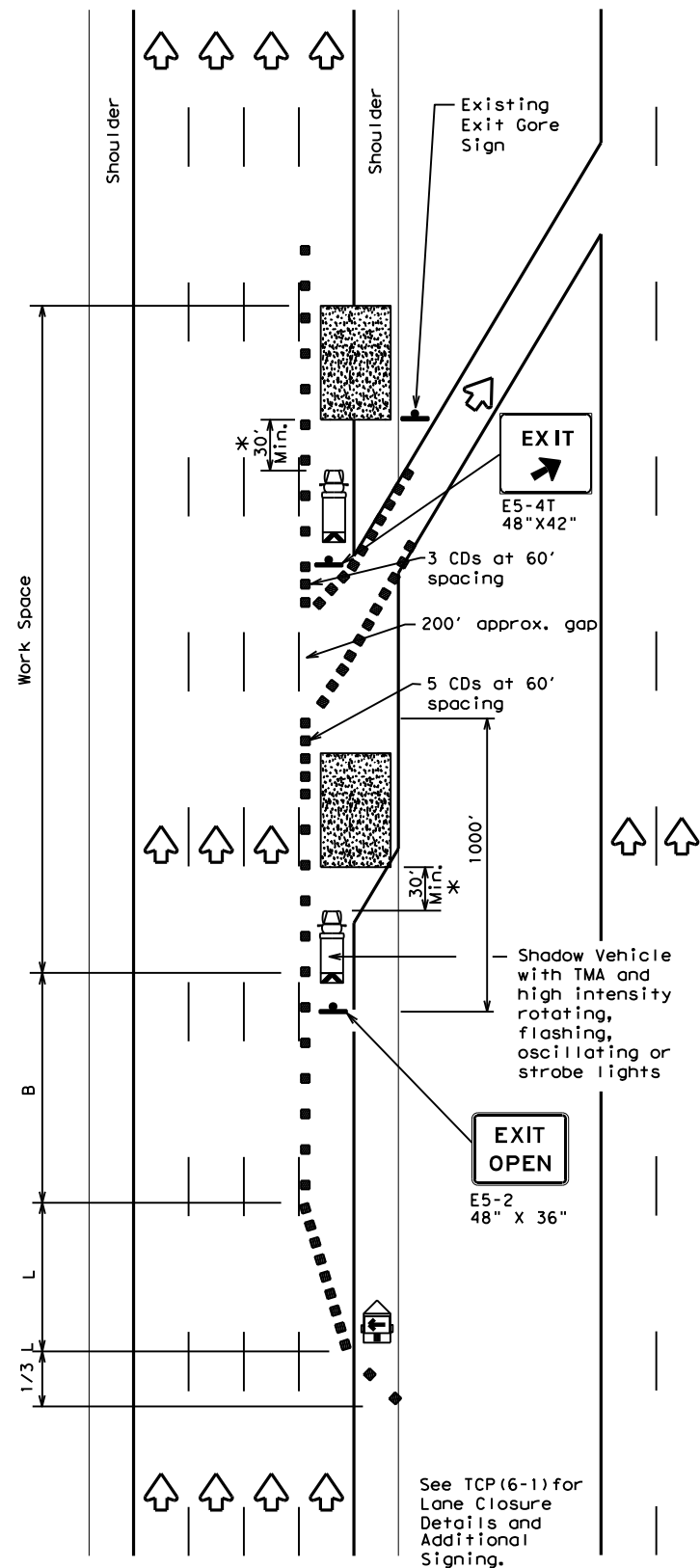

TCP (6-4b)  
**EXIT RAMP OPEN**

LEGEND			
	Type 3 Barricade		Channelizing Devices (CDs)
	Heavy Work Vehicle		Truck Mounted Attenuator (TMA)
	Trailer Mounted Flashing Arrow Board		Portable Changeable Message Sign (PCMS)
	Sign		Traffic Flow
	Flag		Flagger

Posted Speed	Formula	Minimum Desirable Taper Lengths "L"			Suggested Maximum Spacing of Channelizing Devices		Suggested Longitudinal Buffer Space "B"
		10' Offset	11' Offset	12' Offset	On a Taper	On a Tangent	
45	L = WS	450'	495'	540'	45'	90'	195'
50		500'	550'	600'	50'	100'	240'
55		550'	605'	660'	55'	110'	295'
60		600'	660'	720'	60'	120'	350'
65		650'	715'	780'	65'	130'	410'
70		700'	770'	840'	70'	140'	475'
75		750'	825'	900'	75'	150'	540'
80		800'	880'	960'	80'	160'	615'

\*\*Taper lengths have been rounded off.  
 L=Length of Taper (FT) W=Width of Offset (FT) S=Posted Speed (MPH)

TYPICAL USAGE				
MOBILE	SHORT DURATION	SHORT TERM STATIONARY	INTERMEDIATE TERM STATIONARY	LONG TERM STATIONARY
	✓	✓	✓	

**GENERAL NOTES**

- All traffic control devices illustrated are REQUIRED. Devices denoted with the triangle symbol may be omitted when stated elsewhere in the plans.
- See BC Standards for sign details.

\*A shadow vehicle equipped with a Truck Mounted Attenuator is typically required. A shadow vehicle equipped with a TMA shall be used if it can be positioned 30' to 100' in advance of the area of crew exposure without adversely affecting the work performance.

Additional requirements for lane closures and advance signing shall be as shown on TCP (6-1) or as directed by the Engineer.



**TRAFFIC CONTROL PLAN**  
**WORK AREA AT EXIT RAMP**

**TCP (6-4) - 12**

FILE: tcp6-4.dgn	DN: TxDOT	CK: TxDOT	DW: TxDOT	CR: TxDOT
©TxDOT February 1994	CONT	SECT	JOB	HIGHWAY
REVISIONS	6393	46	001	IH0030
1-97 8-98	DIST	COUNTY	SHEET NO.	
4-98 8-12	18	DALLAS	35	

DISCLAIMER: The use of this standard is governed by the "Texas Engineering Practice Act". No warranty of any kind is made by TxDOT for any purpose whatsoever. TxDOT assumes no responsibility for the conversion of units or the use of this standard in any manner other than that intended by the original author.

DATE: 10/14/2021 11:03:47 AM  
 FILE: T:\DALAO\DALNEAO\Maint. Contracts\2022 RMC Folder\Tree Trimming and Brush Removal\6393 46\6393 46.dgn

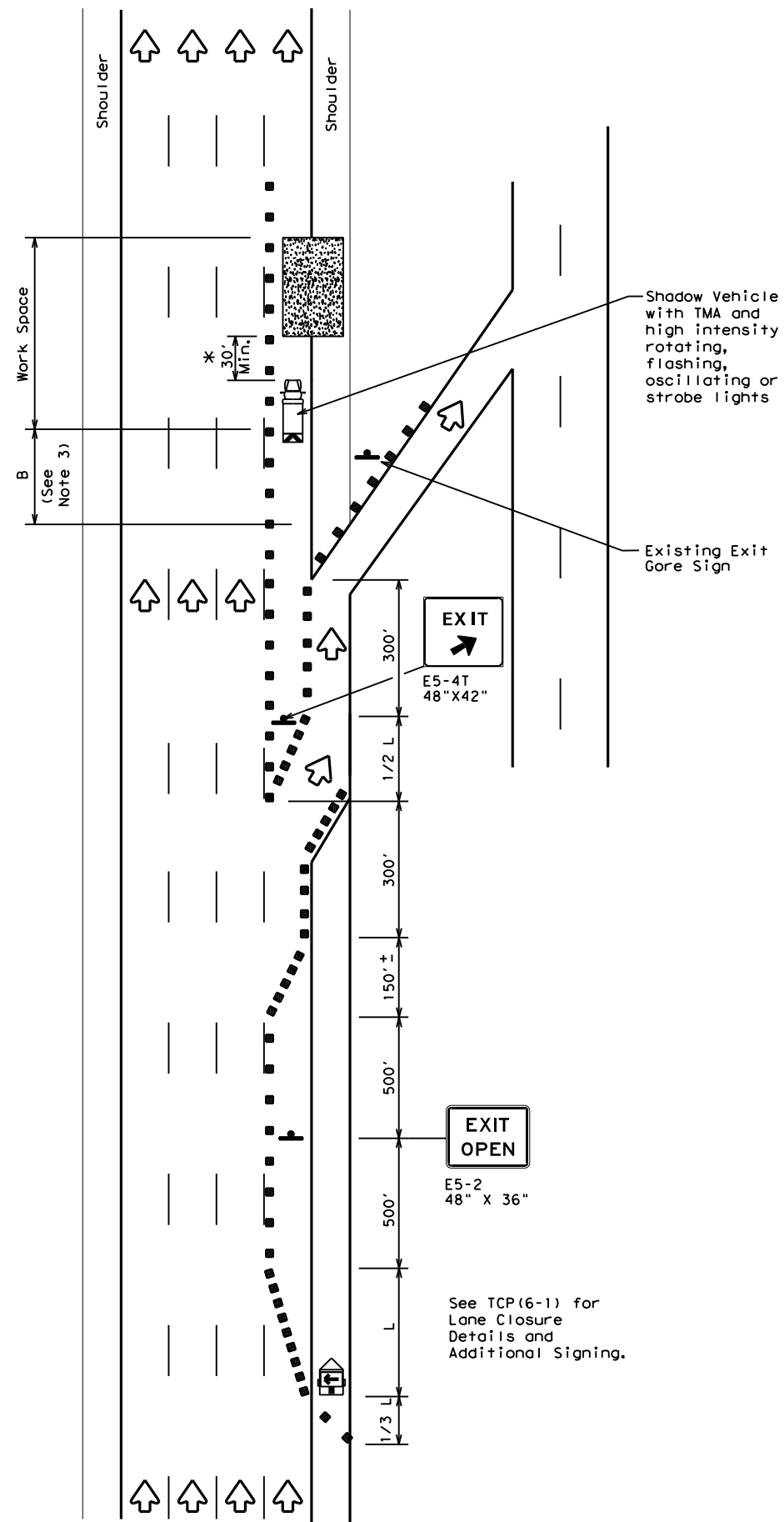

TCP (6-5a)  
**EXIT RAMP OPEN**

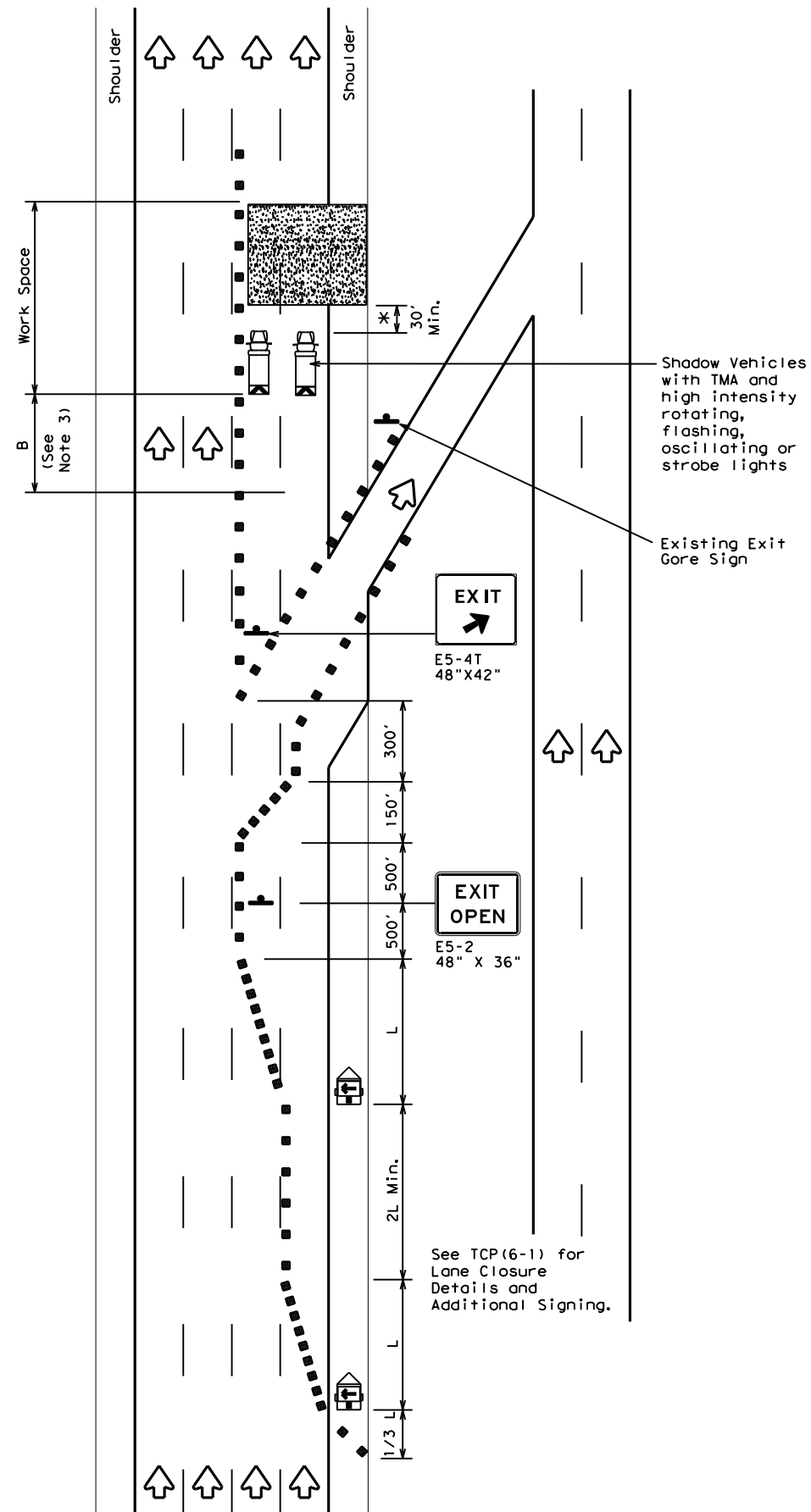

TCP (6-5b)  
**EXIT RAMP OPEN  
 TWO LANE CLOSURE WITHIN  
 1500' PAST EXIT RAMP**

LEGEND			
	Type 3 Barricade		Channelizing Devices
	Heavy Work Vehicle		Truck Mounted Attenuator (TMA)
	Trailer Mounted Flashing Arrow Board		Portable Changeable Message Sign (PCMS)
	Sign		Traffic Flow
	Flag		Flagger

Posted Speed	Formula	Minimum Desirable Taper Lengths "L"			Suggested Maximum Spacing of Channelizing Devices		Suggested Longitudinal Buffer Space "B"
		10' Offset	11' Offset	12' Offset	On a Taper	On a Tangent	
45	L = WS	450'	495'	540'	45'	90'	195'
50		500'	550'	600'	50'	100'	240'
55		550'	605'	660'	55'	110'	295'
60		600'	660'	720'	60'	120'	350'
65		650'	715'	780'	65'	130'	410'
70		700'	770'	840'	70'	140'	475'
75		750'	825'	900'	75'	150'	540'
80		800'	880'	960'	80'	160'	615'

\*\* Taper lengths have been rounded off.  
 L=Length of Taper (FT) W=Width of Offset (FT) S=Posted Speed (MPH)

TYPICAL USAGE				
MOBILE	SHORT DURATION	SHORT TERM STATIONARY	INTERMEDIATE TERM STATIONARY	LONG TERM STATIONARY
	✓	✓	✓	

**GENERAL NOTES**

- All traffic control devices illustrated are REQUIRED. Devices denoted with the triangle symbol may be omitted when stated elsewhere in the plans.
- See BC standards for sign details.
- If adequate longitudinal buffer length "B" does not exist between the work space and the exit ramp, consideration should be given to closing the ramp.

\*A shadow vehicle equipped with a Truck Mounted Attenuator is typically required. A shadow vehicle equipped with a TMA shall be used if it can be positioned 30' to 100' in advance of the area of crew exposure without adversely affecting the work performance.

Additional requirements for lane closures and advance signing shall be as shown on TCP (6-1) or as directed by the Engineer.



**TRAFFIC CONTROL PLAN  
 WORK AREA BEYOND EXIT RAMP**

**TCP (6-5) - 12**

FILE:	tcp6-5.dgn	DN:	TxDOT	CK:	TxDOT	DW:	TxDOT	CK:	TxDOT
© TxDOT	February 1998	CONT:	6393	SECT:	46	JOB:	001	HIGHWAY:	IH0030
REVISIONS:		DIST:	18	COUNTY:	DALLAS	SHEET NO.:	36		



DISCLAIMER: The use of this standard is governed by the "Texas Engineering Practice Act". No warranty of any kind is made by TxDOT for any purpose whatsoever. TxDOT assumes no responsibility for the conversion of units or the use of this standard in any project. The use of this standard is governed by the "Texas Engineering Practice Act". No warranty of any kind is made by TxDOT for any purpose whatsoever. TxDOT assumes no responsibility for the conversion of units or the use of this standard in any project.

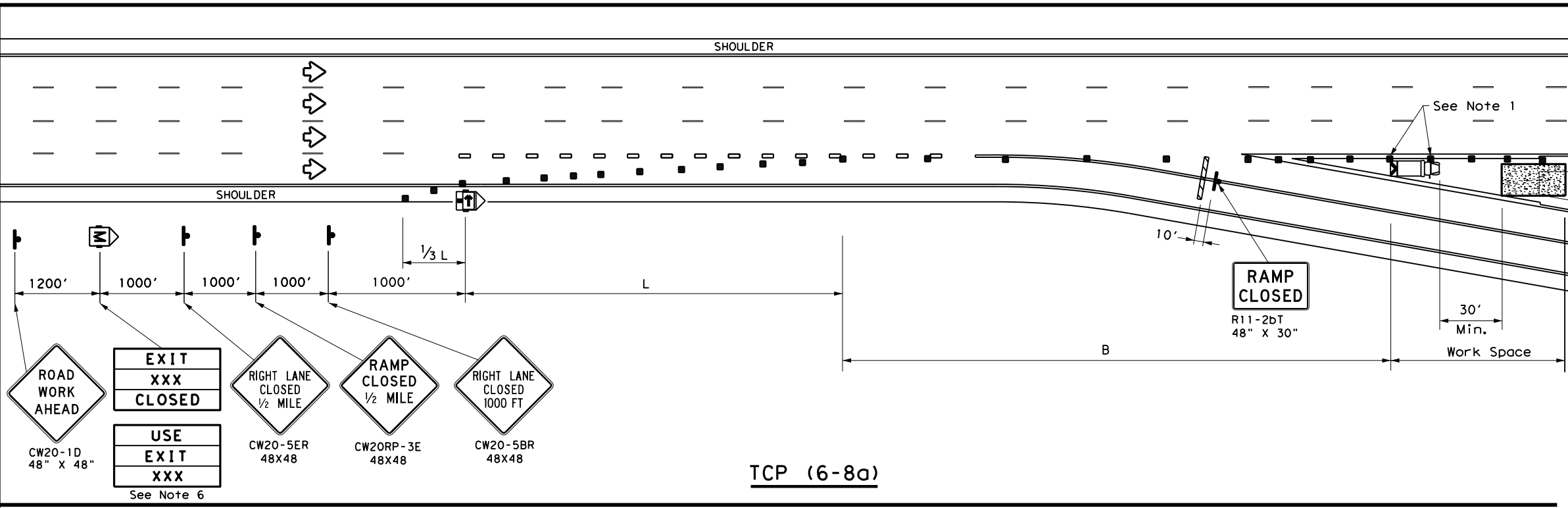

TCP (6-8a)

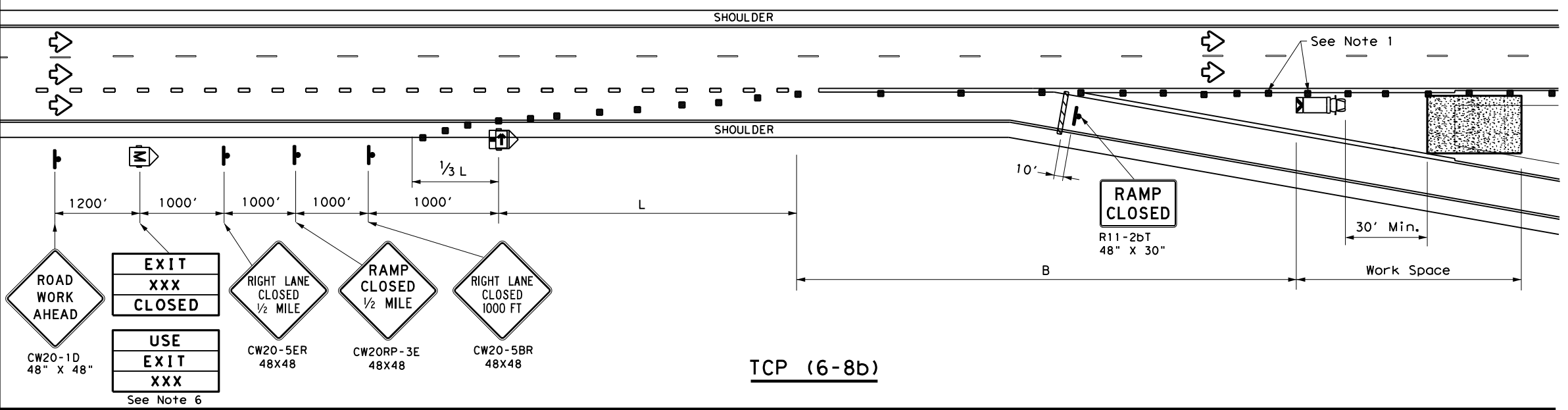

TCP (6-8b)

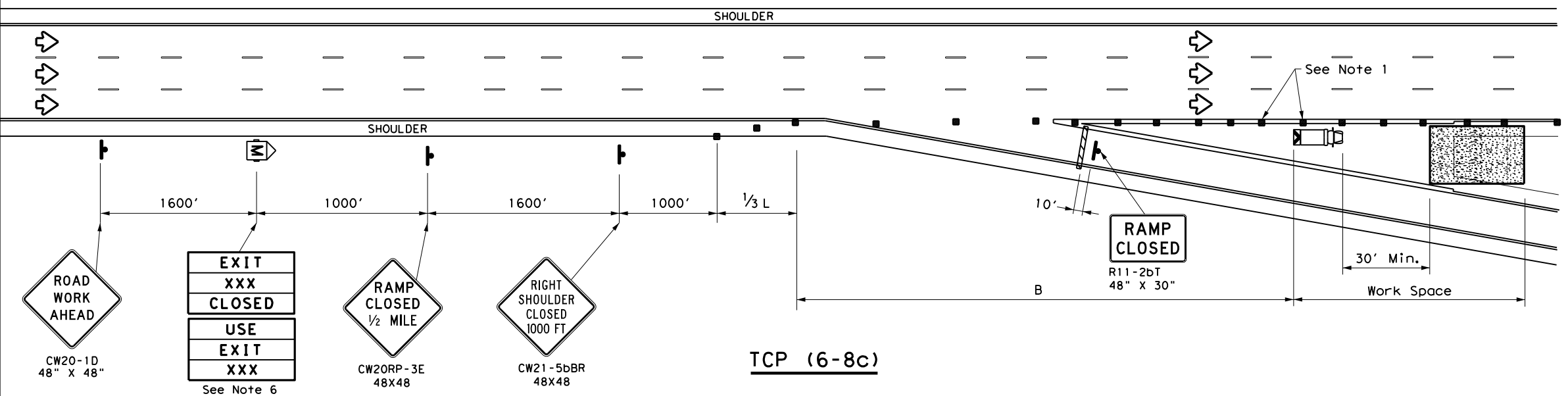

TCP (6-8c)

LEGEND			
	Type 3 Barricade		Channelizing Devices (CDs)
	Heavy Work Vehicle		Truck Mounted Attenuator (TMA)
	Trailer Mounted Flashing Arrow Board		Portable Changeable Message Sign (PCMS)
	Sign		Traffic Flow
	Flag		Flagger

Posted Speed	Formula	Minimum Desirable Taper Lengths "L" **			Suggested Maximum Spacing of Channelizing Devices		Suggested Longitudinal Buffer Space "B"
		10' Offset	11' Offset	12' Offset	On a Taper	On a Tangent	
45	L = WS	450'	495'	540'	45'	90'	195'
50		500'	550'	600'	50'	100'	240'
55		550'	605'	660'	55'	110'	295'
60		600'	660'	720'	60'	120'	350'
65		650'	715'	780'	65'	130'	410'
70		700'	770'	840'	70'	140'	475'
75		750'	825'	900'	75'	150'	540'
80		800'	880'	960'	80'	160'	615'

\*\* Taper lengths have been rounded off.  
 L=Length of Taper (FT) W=Width of Offset (FT)  
 S=Posted Speed (MPH)

TYPICAL USAGE				
MOBILE	SHORT DURATION	SHORT TERM STATIONARY	INTERMEDIATE TERM STATIONARY	LONG TERM STATIONARY
	✓	✓		

- GENERAL NOTES**
- Place channelizing devices in the gore at 20' spacing.
  - See the Standard Highway Sign Design for Texas (SHSD) for sign details.
  - The PCMS may be omitted when a permanent DMS sign is available in an appropriate location to display a similar message as called for on the PCMS.
  - When it is determined that a through lane should be closed in addition to the exit ramp, refer to TCP(6-4) for traffic control details.
  - Truck mounted attenuator is required.
  - The PCMS may be omitted if replaced with a "RAMP CLOSED" AHEAD (CW20RP-3D) Sign.
  - Roadway ADT should be greater than 10,000.



**WORK IN EXIT GORE FOR ADT GREATER THAN 10,000**

**TCP (6-8) - 14**

FILE: tcp6-8.dgn	DN: TxDOT	CK: TxDOT	DW: TxDOT	CK: TxDOT
© TxDOT February 2014	CONT: 6393	SECT: 46	JOB: 001	HIGHWAY: IH0030
REVISIONS	DIST: 18	COUNTY: DALLAS	SHEET NO. 37	

DISCLAIMER: The use of this standard is governed by the "Texas Engineering Practice Act". No warranty of any kind is made by TxDOT for any purpose whatsoever. TxDOT assumes no responsibility for the conversion of units or the accuracy of the information presented herein. The user of this standard is responsible for the accuracy of the information presented herein.

DATE: 10/14/2021 11:03:52 AM  
 FILE: I:\DALAO\DALNEAO\Maint. Contracts\2022 RMC Folder\Tree Trimming and Brush Removal\6393\6393.dgn

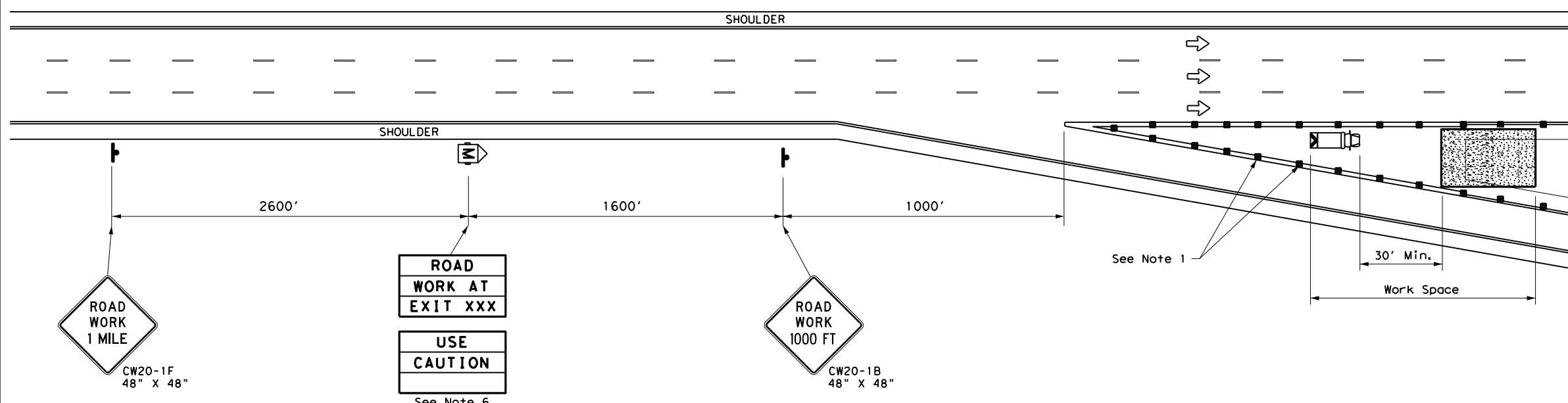

TCP (6-9a)

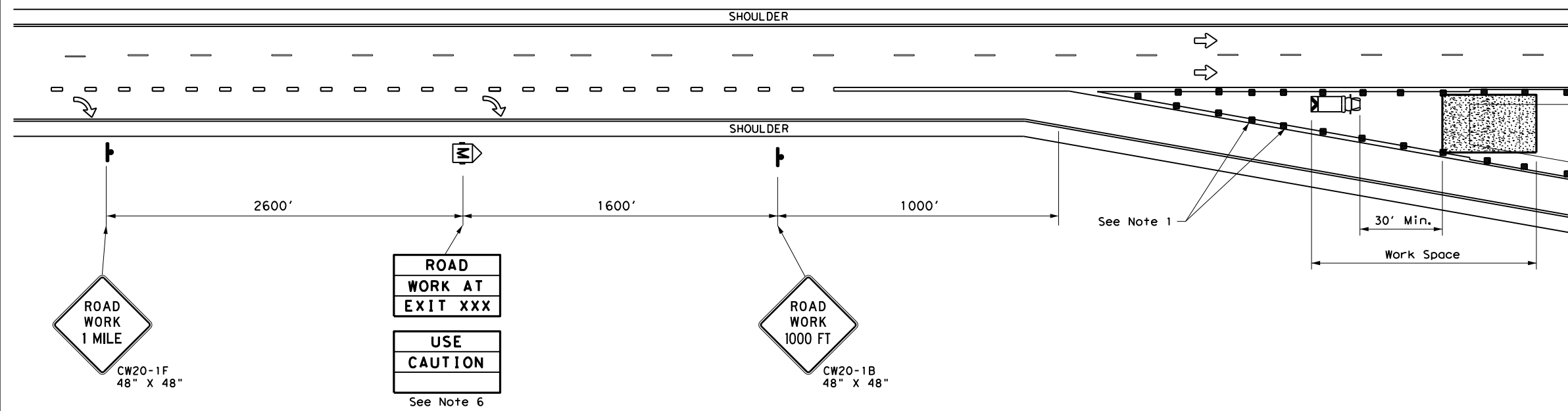

TCP (6-9b)

LEGEND			
	Type 3 Barricade		Channelizing Devices (CDs)
	Heavy Work Vehicle		Truck Mounted Attenuator (TMA)
	Trailer Mounted Flashing Arrow Board		Portable Changeable Message Sign (PCMS)
	Sign		Traffic Flow
	Flag		Flagger

Posted Speed	Formula	Minimum Desirable Taper Lengths "L" **			Suggested Maximum Spacing of Channelizing Devices		Suggested Longitudinal Buffer Space "B"
		10' Offset	11' Offset	12' Offset	On a Taper	On a Tangent	
45	L = WS	450'	495'	540'	45'	90'	195'
50		500'	550'	600'	50'	100'	240'
55		550'	605'	660'	55'	110'	295'
60		600'	660'	720'	60'	120'	350'
65		650'	715'	780'	65'	130'	410'
70		700'	770'	840'	70'	140'	475'
75		750'	825'	900'	75'	150'	540'
80		800'	880'	960'	80'	160'	615'

\*\* Taper lengths have been rounded off.  
 L=Length of Taper (FT) W=Width of Offset (FT)  
 S=Posted Speed (MPH)

TYPICAL USAGE				
MOBILE	SHORT DURATION	SHORT TERM STATIONARY	INTERMEDIATE TERM STATIONARY	LONG TERM STATIONARY
	✓	✓		

- GENERAL NOTES**
- Place channelizing devices in the gore at 20' spacing.
  - See the Standard Highway Sign Design for Texas (SHSD) for sign details.
  - The PCMS may be omitted when a permanent DMS sign is available in an appropriate location to display a similar message as called for on the PCMS.
  - When it is determined that a through lane should be closed in addition to the exit ramp, refer to TCP (6-4) and TCP (6-8) for traffic control details.
  - Truck mounted attenuators are required.
  - The PCMS may be omitted if replaced with a "ROAD WORK 1/2 MILE" (CW20-1E).
  - Roadway ADT should be less than 10,000.



**WORK IN EXIT GORE  
 FOR ADT LESS THAN 10,000**

**TCP (6-9) - 14**

FILE: tcp6-9.dgn	DN: TxDOT	CK: TxDOT	DW: TxDOT	CK: TxDOT
© TxDOT February 2014	CONT	SECT	JOB	HIGHWAY
REVISIONS	6393	46	001	IH0030
	DIST	COUNTY	SHEET NO.	
	18	DALLAS	38	